

Information technology equipment — Safety —

Part 1: General requirements

The European Standard EN 60950-1:2006 has the status of a
British Standard

ICS 35.020; 35.260

National foreword

This British Standard is the official English language version of EN 60950-1:2006. It was derived by CENELEC from IEC 60950-1:2005. It supersedes BS EN 60950-1:2002 which will be withdrawn on 1 December 2010.

The CENELEC common modifications have been implemented at the appropriate places in the text and are indicated by tags (e.g. **Ⓒ** **Ⓒ**).

The UK participation in its preparation was entrusted to Technical Committee EPL/108, Safety of electronic equipment within the field of audio/video, information technology and communication technology, which has the responsibility to:

- aid enquirers to understand the text;
- present to the responsible international/European committee any enquiries on the interpretation, or proposals for change, and keep UK interests informed;
- monitor related international and European developments and promulgate them in the UK.

A list of organizations represented on this committee can be obtained on request to its secretary.

Cross-references

The British Standards which implement international or European publications referred to in this document may be found in the *BSI Catalogue* under the section entitled “International Standards Correspondence Index”, or by using the “Search” facility of the *BSI Electronic Catalogue* or of British Standards Online.

This publication does not purport to include all the necessary provisions of a contract. Users are responsible for its correct application.

Compliance with a British Standard does not of itself confer immunity from legal obligations.

Summary of pages

This document comprises a front cover, an inside front cover, the EN title page, pages 2 to 312, an inside back cover and a back cover.

The BSI copyright notice displayed in this document indicates when the document was last issued.

Amendments issued since publication

| Amd. No. | Date | Comments |
|----------|------|----------|
| | | |
| | | |
| | | |
| | | |

This British Standard was published under the authority of the Standards Policy and Strategy Committee on 31 May 2006

© BSI 2006

ISBN 0 580 48469 6

English version

**Information technology equipment -
Safety****Part 1: General requirements
(IEC 60950-1:2005, modified)**Matériel de traitement de l'information -
SécuritéPartie 1: Exigences générales
(CEI 60950-1:2005, modifiée)Einrichtungen der Informationstechnik -
SicherheitTeil 1: Allgemeine Anforderungen
(IEC 60950-1:2005, modifiziert)

This European Standard was approved by CENELEC on 2005-12-01. CENELEC members are bound to comply with the CEN/CENELEC Internal Regulations which stipulate the conditions for giving this European Standard the status of a national standard without any alteration.

Up-to-date lists and bibliographical references concerning such national standards may be obtained on application to the Central Secretariat or to any CENELEC member.

This European Standard exists in three official versions (English, French, German). A version in any other language made by translation under the responsibility of a CENELEC member into its own language and notified to the Central Secretariat has the same status as the official versions.

CENELEC members are the national electrotechnical committees of Austria, Belgium, Cyprus, the Czech Republic, Denmark, Estonia, Finland, France, Germany, Greece, Hungary, Iceland, Ireland, Italy, Latvia, Lithuania, Luxembourg, Malta, the Netherlands, Norway, Poland, Portugal, Romania, Slovakia, Slovenia, Spain, Sweden, Switzerland and the United Kingdom.

CENELECEuropean Committee for Electrotechnical Standardization
Comité Européen de Normalisation Electrotechnique
Europäisches Komitee für Elektrotechnische Normung**Central Secretariat: rue de Stassart 35, B - 1050 Brussels**

Foreword

The text of document 108/135A/FDIS, future edition 2 of IEC 60950-1, prepared by IEC TC 108, Safety of electronic equipment within the field of audio/video, information technology and communication technology, was submitted to the IEC-CENELEC parallel.

This text, together with a draft amendment, prepared by the Technical Committee CENELEC TC 108, Safety of electronic equipment within the fields of audio/video, information technology and communication technology, and submitted to the formal vote, was approved by CENELEC as EN 60950-1 on 2005-12-01.

This European Standard supersedes EN 60950-1:2001 + corrigendum April 2004 + A11:2004.

EN 60950-1 includes the basic requirements for the safety of information technology equipment.

Additional parts of EN 60950-1 will cover specific safety requirements for information technology equipment having limited applications or having special features as follows:

Part 21: Remote power feeding;

Part 22: Equipment installed outdoors;

Part 23: Large data storage equipment.

Except for notes, all text within a normative figure, or in a box under a normative table, is also normative. Text with a superscript reference is linked to a particular item in the table. Other text in a box under a table applies to the whole table.

Informative annexes and text beginning with the word "NOTE" are not normative. They are provided only to give additional information.

In this standard, the following print types are used:

- Requirements proper and normative annexes: roman type.
- *Compliance statements and test specifications: italic type.*
- Notes in the text and in tables: smaller roman type.
- Terms that are defined in 1.2: SMALL CAPITALS.

The following dates were fixed:

- | | | |
|--|-------|------------|
| - latest date by which the EN has to be implemented at national level by publication of an identical national standard or by endorsement | (dop) | 2006-12-01 |
| - latest date by which the national standards conflicting with the EN have to be withdrawn | (dow) | 2010-12-01 |

Clauses, subclauses, notes, tables and figures which are additional to those in IEC 60950-1 are prefixed "Z".

Annexes ZA, ZB and ZC have been added by CENELEC.

Endorsement notice

The text of the International Standard IEC 60950-1:2005 was approved by CENELEC as a European Standard with agreed common modifications.

CONTENTS

| | |
|--|-----|
| INTRODUCTION..... | 9 |
| 0 Principles of safety | 9 |
| 0.1 General principles of safety | 9 |
| 0.2 Hazards | 10 |
| 0.3 Materials and components | 14 |
| 1 General..... | 15 |
| 1.1 Scope..... | 15 |
| 1.2 Definitions | 17 |
| 1.3 General requirements | 33 |
| 1.4 General conditions for tests | 34 |
| 1.5 Components | 39 |
| 1.6 Power interface | 46 |
| 1.7 Markings and instructions | 46 |
| 2 Protection from hazards..... | 54 |
| 2.1 Protection from electric shock and energy hazards | 54 |
| 2.2 SELV circuits..... | 63 |
| 2.3 TNV circuits..... | 65 |
| 2.4 Limited current circuits..... | 70 |
| 2.5 Limited power sources | 71 |
| 2.6 Provisions for earthing and bonding | 73 |
| 2.7 Overcurrent and earth fault protection in primary circuits | 81 |
| 2.8 Safety interlocks..... | 84 |
| 2.9 Electrical insulation | 87 |
| 2.10 Clearances, creepage distances and distances through insulation | 92 |
| 3 Wiring, connections and supply..... | 120 |
| 3.1 General | 120 |
| 3.2 Connection to a mains supply | 123 |
| 3.3 Wiring terminals for connection of external conductors | 130 |
| 3.4 Disconnection from the mains supply | 133 |
| 3.5 Interconnection of equipment | 136 |
| 4 Physical requirements | 137 |
| 4.1 Stability..... | 137 |
| 4.2 Mechanical strength..... | 138 |
| 4.3 Design and construction | 142 |
| 4.4 Protection against hazardous moving parts | 151 |
| 4.5 Thermal requirements..... | 152 |
| 4.6 Openings in enclosures | 156 |
| 4.7 Resistance to fire..... | 163 |
| 5 Electrical requirements and simulated abnormal conditions | 172 |
| 5.1 Touch current and protective conductor current..... | 172 |
| 5.2 Electric strength | 181 |
| 5.3 Abnormal operating and fault conditions..... | 185 |

| | | |
|-----|--|-----|
| 6 | Connection to telecommunication networks | 189 |
| 6.1 | Protection of telecommunication network service persons, and users of other equipment connected to the network, from hazards in the equipment..... | 190 |
| 6.2 | Protection of equipment users from overvoltages on telecommunication networks | 192 |
| 6.3 | Protection of the telecommunication wiring system from overheating | 194 |
| 7 | Connection to cable distribution systems..... | 195 |
| 7.1 | General..... | 195 |
| 7.2 | Protection of cable distribution system service persons, and users of other equipment connected to the system, from hazardous voltages in the equipment..... | 195 |
| 7.3 | Protection of equipment users from overvoltages on the cable distribution system..... | 195 |
| 7.4 | Insulation between primary circuits and cable distribution systems..... | 196 |
| | Annex A (normative) Tests for resistance to heat and fire | 198 |
| | Annex B (normative) Motor tests under abnormal conditions | 201 |
| | Annex C (normative) Transformers..... | 207 |
| | Annex D (normative) Measuring instruments for touch current tests | 211 |
| | Annex E (normative) Temperature rise of a winding | 213 |
| | Annex F (normative) Measurement of clearances and creepage distances | 214 |
| | Annex G (normative) Alternative method for determining minimum clearances | 222 |
| | Annex H (normative) Ionizing radiation | 230 |
| | Annex J (normative) Table of electrochemical potentials (see 2.6.5.6)..... | 231 |
| | Annex K (normative) Thermal controls..... | 232 |
| | Annex L (normative) Normal load conditions for some types of electrical business equipment | 234 |
| | Annex M (normative) Criteria for telephone ringing signals..... | 236 |
| | Annex N (normative) Impulse test generators | 241 |
| | Annex P (normative) Normative references..... | 243 |
| | Annex Q (normative) Voltage dependent resistors (VDRs) | 247 |
| | Annex R (informative) Examples of requirements for quality control programmes | 248 |
| | Annex S (informative) Procedure for impulse testing..... | 251 |
| | Annex T (informative) Guidance on protection against ingress of water | 253 |
| | Annex U (normative) Insulated winding wires for use without interleaved insulation | 255 |
| | Annex V (normative) AC power distribution systems | 258 |
| | Annex W (informative) Summation of touch currents | 265 |
| | Annex X (informative) Maximum heating effect in transformer tests..... | 268 |
| | Annex Y (normative) Ultraviolet light conditioning test..... | 270 |
| | Annex Z (informative) Overvoltage categories (see 2.10.3.2 and Clause G.2)..... | 271 |
| | Annex AA (normative) Mandrel test (see 2.10.5.8) | 272 |
| | Annex BB (informative) Changes in the second edition | 275 |
| | Annex ZA (normative) Normative references to international publications with their corresponding European publications | 303 |
| | Annex ZB (normative) Special national conditions | 307 |
| | Annex ZC (informative) A-deviations | 311 |

| | |
|---|-----|
| Bibliography | 278 |
| Index | 281 |
| Figure 2A – Test finger | 56 |
| Figure 2B – Test pin | 57 |
| Figure 2C – Test probe | 57 |
| Figure 2D - Accessibility of internal conductive parts | 58 |
| Figure 2E – Voltages in SELV circuits under single fault conditions..... | 64 |
| Figure 2F – Maximum voltages permitted after a single fault | 66 |
| Figure 2G – Test generator | 70 |
| Figure 2H – Examples of application of insulation | 91 |
| Figure 2J – Thermal ageing time | 117 |
| Figure 2K – Abrasion resistance test for coating layers..... | 118 |
| Figure 4A – Impact test using a steel ball | 140 |
| Figure 4B – Examples of cross-sections of designs of openings preventing vertical access..... | 157 |
| Figure 4C – Examples of louvre design | 157 |
| Figure 4D – Enclosure openings..... | 158 |
| Figure 4E – Typical bottom of a fire enclosure for partially enclosed component or assembly..... | 159 |
| Figure 4F – Baffle plate construction | 160 |
| Figure 5A – Test circuit for touch current of single-phase equipment on a star TN or TT power supply system | 174 |
| Figure 5B – Test circuit for touch current of three-phase equipment on a star TN or TT power supply system | 174 |
| Figure 6A – Test for separation between a telecommunication network and earth..... | 191 |
| Figure 6B – Application points of test voltage | 192 |
| Figure B.1 – Determination of arithmetic average temperature | 202 |
| Figure C.1 – Determination of arithmetic average temperature | 208 |
| Figure D.1 – Measuring instrument..... | 211 |
| Figure D.2 – Alternative measuring instrument | 212 |
| Figure F.1 – Narrow groove | 215 |
| Figure F.2 – Wide groove..... | 215 |
| Figure F.3 – V-shaped groove | 215 |
| Figure F.4 – Rib..... | 215 |
| Figure F.5 – Uncemented joint with narrow groove | 216 |
| Figure F.6 – Uncemented joint with wide groove | 216 |
| Figure F.7 – Uncemented joint with narrow and wide grooves | 216 |
| Figure F.8 – Narrow recess..... | 217 |
| Figure F.9 – Wide recess | 217 |
| Figure F.10 – Coating around terminals..... | 218 |

| | |
|---|-----|
| Figure F.11 – Coating over printed wiring | 218 |
| Figure F.12 – Measurements through openings in enclosures | 219 |
| Figure F.13 – Intervening, unconnected conductive part | 219 |
| Figure F.14 – Solid insulating material..... | 220 |
| Figure F.15 – Thin sheet insulating material | 220 |
| Figure F.16 – Cemented joints in multi-layer printed board..... | 220 |
| Figure F.17 – Component filled with insulating compound | 221 |
| Figure F.18 – Partitioned bobbin | 221 |
| Figure M.1 – Definition of ringing period and cadence cycle | 237 |
| Figure M.2 – I_{TS1} limit curve for cadenced ringing signal | 238 |
| Figure M.3 – Peak and peak-to-peak currents..... | 238 |
| Figure M.4 – Ringing voltage trip criteria | 240 |
| Figure N.1 – ITU-T impulse test generator circuit..... | 241 |
| Figure N.2 – IEC 60065 impulse test generator circuit | 242 |
| Figure S.1 – Waveform on insulation without surge suppressors and no breakdown | 251 |
| Figure S.2 – Waveforms on insulation during breakdown without surge suppressors | 252 |
| Figure S.3 – Waveforms on insulation with surge suppressors in operation | 252 |
| Figure S.4 – Waveform on short-circuited surge suppressor and insulation | 252 |
| Figure V.1 – Examples of TN-S power distribution systems..... | 260 |
| Figure V.2 – Example of TN-C-S power distribution system..... | 261 |
| Figure V.3 – Example of TN-C power distribution system..... | 261 |
| Figure V.4 – Example of single-phase, three-wire TN-C power distribution system | 262 |
| Figure V.5 – Example of three line and neutral TT power distribution system..... | 262 |
| Figure V.6 – Example of three line TT power distribution system..... | 263 |
| Figure V.7 – Example of three line (and neutral) IT power distribution system | 263 |
| Figure V.8 – Example of three line IT power distribution system..... | 264 |
| Figure W.1 – Touch current from a floating circuit..... | 265 |
| Figure W.2 – Touch current from an earthed circuit | 266 |
| Figure W.3 – Summation of touch currents in a PABX..... | 266 |
| Figure AA.1 – Mandrel | 272 |
| Figure AA.2 – Initial position of mandrel | 273 |
| Figure AA.3 – Final position of mandrel | 273 |
| Table 1A – Voltage ranges of SELV and TNV circuits | 25 |
| Table 1B – Equivalence of flammability classes..... | 29 |
| Table 1C – Capacitor ratings according to IEC 60384-14 | 41 |
| Table 1D – Informative examples of application of capacitors | 42 |
| Table 2A – Distance through insulation of internal wiring | 59 |
| Table 2B – Limits for power sources without an overcurrent protective device | 72 |
| Table 2C – Limits for power sources with an overcurrent protective device..... | 72 |

| | |
|---|-----|
| Table 2D – Minimum size of protective bonding conductors | 76 |
| Table 2E – Test duration, a.c. mains supplies..... | 77 |
| Table 2F – Informative examples of protective devices in single-phase equipment or subassemblies..... | 83 |
| Table 2G – Informative examples of protective devices in three-phase equipment | 83 |
| Table 2H – Examples of application of insulation | 89 |
| Table 2J – AC mains transient voltages..... | 97 |
| Table 2K – Minimum clearances for insulation in primary circuits and between primary and secondary circuits | 98 |
| Table 2L – Additional clearances in primary circuits..... | 99 |
| Table 2M – Minimum clearances in secondary circuits | 100 |
| Table 2N – Minimum creepage distances | 105 |
| Table 2P – Tests for insulation in non-separable layers | 109 |
| Table 2Q – Minimum separation distances for coated printed boards | 114 |
| Table 2R – Insulation in printed boards | 115 |
| Table 3A – Sizes of cables and conduits for equipment having a rated current not exceeding 16 A..... | 125 |
| Table 3B – Sizes of conductors | 127 |
| Table 3C – Physical tests on power supply cords | 129 |
| Table 3D – Range of conductor sizes to be accepted by terminals | 131 |
| Table 3E – Sizes of terminals for mains supply conductors and protective earthing conductors | 132 |
| Table 4A – Minimum property retention limits after UV exposure..... | 148 |
| Table 4B – Temperature limits, materials and components..... | 154 |
| Table 4C – Touch temperature limits..... | 155 |
| Table 4D – Size and spacing of openings in metal bottoms of fire enclosures..... | 161 |
| Table 4E – Summary of material flammability requirements | 171 |
| Table 5A – Maximum current..... | 176 |
| Table 5B – Test voltages for electric strength tests based on peak working voltages Part 1.. | 183 |
| Table 5B – Test voltages for electric strength tests based on peak working voltages Part 2.. | 184 |
| Table 5C – Test voltages for electric strength tests based on required withstand voltages . | 185 |
| Table 5D – Temperature limits for overload conditions..... | 189 |
| Table B.1 – Temperature limits for motor windings (except for running overload test) | 202 |
| Table B.2 – Permitted temperature limits for running overload tests | 203 |
| Table C.1 – Temperature limits for transformer windings..... | 208 |
| Table F.1 – Value of X | 214 |
| Table G.1 – AC mains transient voltages | 223 |

| | |
|---|-----|
| Table G.2 – Minimum clearances up to 2 000 m above sea level..... | 228 |
| Table J.1 – Electrochemical potentials (V)..... | 231 |
| Table N.1 – Component values for Figures N.1 and N.2..... | 242 |
| Table R.1 – Rules for sampling and inspection – coated printed boards | 249 |
| Table R.2 – Rules for sampling and inspection – reduced clearances..... | 250 |
| Table T.1 – Extract from IEC 60529 | 254 |
| Table U.1 – Mandrel diameter | 256 |
| Table U.2 – Oven temperature | 256 |
| Table X.1 – Test steps | 269 |
| Table Z.1 – Overvoltage categories..... | 271 |



INTRODUCTION

0 Principles of safety

The following principles have been adopted by technical committee 108 in the development of this standard.

These principles do not cover performance or functional characteristics of equipment.

Words printed in SMALL CAPITALS are terms that are defined in 1.2 of this standard.

0.1 General principles of safety

It is essential that designers understand the underlying principles of safety requirements in order that they can engineer safe equipment.

These principles are not an alternative to the detailed requirements of this standard, but are intended to provide designers with an appreciation of the basis of these requirements. Where the equipment involves technologies and materials or methods of construction not specifically covered, the design of the equipment should provide a level of safety not less than those described in these principles of safety.

Designers shall take into account not only normal operating conditions of the equipment but also likely fault conditions, consequential faults, foreseeable misuse and external influences such as temperature, altitude, pollution, moisture, overvoltages on the MAINS SUPPLY and overvoltages on a TELECOMMUNICATION NETWORK or a CABLE DISTRIBUTION SYSTEM. Dimensioning of insulation spacings should take account of possible reductions by manufacturing tolerances, or where deformation could occur due to handling, shock and vibration likely to be encountered during manufacture, transport and normal use.

The following priorities should be observed in determining what design measures to adopt:

- where possible, specify design criteria that will eliminate, reduce or guard against hazards;
- where the above is not practicable because the functioning of the equipment would be impaired, specify the use of protective means independent of the equipment, such as personal protective equipment (which is not specified in this standard);
- where neither of the above measures is practicable, or in addition to those measures, specify the provision of markings and instructions regarding the residual risks.

There are two types of persons whose safety needs to be considered, USERS (or OPERATORS) and SERVICE PERSONS.

USER is the term applied to all persons other than SERVICE PERSONS. Requirements for protection should assume that USERS are not trained to identify hazards, but will not intentionally create a hazardous situation. Consequently, the requirements will provide protection for cleaners and casual visitors as well as the assigned USERS. In general, USERS should not have access to hazardous parts, and to this end, such parts should only be in SERVICE ACCESS AREAS or in equipment located in RESTRICTED ACCESS LOCATIONS.

When USERS are admitted to RESTRICTED ACCESS LOCATIONS they shall be suitably instructed.

SERVICE PERSONS are expected to use their training and skill to avoid possible injury to themselves and others due to obvious hazards that exist in SERVICE ACCESS AREAS of the equipment or on equipment located in RESTRICTED ACCESS LOCATIONS. However, SERVICE

PERSONS should be protected against unexpected hazards. This can be done by, for example, locating parts that need to be accessible for servicing away from electrical and mechanical hazards, providing shields to avoid accidental contact with hazardous parts, and providing labels or instructions to warn personnel about any residual risk.

Information about potential hazards can be marked on the equipment or provided with the equipment, depending on the likelihood and severity of injury, or made available for SERVICE PERSONS. In general, USERS shall not be exposed to hazards likely to cause injury, and information provided for USERS should primarily aim at avoiding misuse and situations likely to create hazards, such as connection to the wrong power source and replacement of fuses by incorrect types.

MOVABLE EQUIPMENT is considered to present a slightly increased risk of shock, due to possible extra strain on the supply cord leading to rupture of the earthing conductor. With HAND-HELD EQUIPMENT, this risk is increased; wear on the cord is more likely, and further hazards could arise if the units were dropped. TRANSPORTABLE EQUIPMENT introduces a further factor because it can be used and carried in any orientation; if a small metallic object enters an opening in the ENCLOSURE it can move around inside the equipment, possibly creating a hazard.

0.2 Hazards

Application of a safety standard is intended to reduce the risk of injury or damage due to the following:

- electric shock;
- energy related hazards;
- fire;
- heat related hazards;
- mechanical hazards;
- radiation;
- chemical hazards.

0.2.1 Electric shock

Electric shock is due to current passing through the human body. The resulting physiological effects depend on the value and duration of the current and the path it takes through the body. The value of the current depends on the applied voltage, the impedance of the source and the impedance of the body. The body impedance depends in turn on the area of contact, moisture in the area of contact and the applied voltage and frequency. Currents of approximately half a milliampere can cause a reaction in persons in good health and may cause injury indirectly due to involuntary reaction. Higher currents can have more direct effects, such as burn or muscle tetanization leading to inability to let go or to ventricular fibrillation.

Steady state voltages up to 42.4 V peak, or 60 V d.c., are not generally regarded as hazardous under dry conditions for an area of contact equivalent to a human hand. Bare parts that have to be touched or handled should be at earth potential or properly insulated.

Some equipment will be connected to telephone and other external networks. Some TELECOMMUNICATION NETWORKS operate with signals such as voice and ringing superimposed on a steady d.c. supply voltage; the total may exceed the values given above for steady-state voltages. It is common practice for the SERVICE PERSONS of telephone companies to handle parts of such circuits bare-handed. This has not caused serious injury, because of the use of cadenced ringing and because there are limited areas of contact with bare conductors normally handled by SERVICE PERSONS. However, the area of contact of a part accessible to the USER, and the likelihood of the part being touched, should be further limited (for example, by the shape and location of the part).

It is normal to provide two levels of protection for USERS to prevent electric shock. Therefore, the operation of equipment under normal conditions and after a single fault, including any consequential faults, should not create a shock hazard. However, provision of additional protective measures, such as protective earthing or SUPPLEMENTARY INSULATION, is not considered a substitute for, or a relief from, properly designed BASIC INSULATION.

Harm may result from:

Contact with bare parts normally at HAZARDOUS VOLTAGES.

Breakdown of insulation between parts normally at HAZARDOUS VOLTAGES and accessible conductive parts.

Examples of measures to reduce risks:

Prevent USER access to parts at HAZARDOUS VOLTAGES by fixed or locked covers, SAFETY INTERLOCKS, etc. Discharge accessible capacitors that are at HAZARDOUS VOLTAGES.

Provide BASIC INSULATION and connect the accessible conductive parts and circuits to earth so that exposure to the voltage which can develop is limited because overcurrent protection will disconnect the parts having low impedance faults within a specified time; or provide a metal screen connected to protective earth between the parts, or provide DOUBLE INSULATION or REINFORCED INSULATION between the parts, so that breakdown to the accessible part is not likely to occur.

Contact with circuits connected to TELECOMMUNICATION NETWORKS that exceed 42,4 V peak or 60 V d.c.

Limit the accessibility and area of contact of such circuits, and separate them from unearthed parts to which access is not limited.

Breakdown of USER-accessible insulation.

Insulation that is accessible to the USER should have adequate mechanical and electrical strength to reduce the likelihood of contact with HAZARDOUS VOLTAGES.

TOUCH CURRENT (leakage current) flowing from parts at HAZARDOUS VOLTAGES to accessible parts, or failure of a protective earthing connection. TOUCH CURRENT may include current due to EMC filter components connected between PRIMARY CIRCUITS and accessible parts.

Limit TOUCH CURRENT to a specified value, or provide a high integrity protective earthing connection.

0.2.2 Energy related hazards

Injury or fire may result from a short-circuit between adjacent poles of high current supplies or high capacitance circuits, causing:

- burns;
- arcing;
- ejection of molten metal.

Even circuits whose voltages are safe to touch may be hazardous in this respect.

Examples of measures to reduce risks include:

- separation;
- shielding;
- provision of SAFETY INTERLOCKS.

0.2.3 Fire

Risk of fire may result from excessive temperatures either under normal operating conditions or due to overload, component failure, insulation breakdown or loose connections. Fires originating within the equipment should not spread beyond the immediate vicinity of the source of the fire, nor cause damage to the surroundings of the equipment.

Examples of measures to reduce risks include:

- providing overcurrent protection;
- using constructional materials having appropriate flammability properties for their purpose;
- selection of parts, components and consumable materials to avoid high temperature which might cause ignition;
- limiting the quantity of combustible materials used;

- shielding or separating combustible materials from likely ignition sources;
- using ENCLOSURES or barriers to limit the spread of fire within the equipment;
- using suitable materials for ENCLOSURES so as to reduce the likelihood of fire spreading from the equipment.

0.2.4 Heat related hazards

Injury may result from high temperatures under normal operating conditions, causing:

- burns due to contact with hot accessible parts;
- degradation of insulation and of safety-critical components;
- ignition of flammable liquids.

Examples of measures to reduce risks include:

- taking steps to avoid high temperature of accessible parts;
- avoiding temperatures above the ignition point of liquids;
- provision of markings to warn USERS where access to hot parts is unavoidable.

0.2.5 Mechanical hazards

Injury may result from:

- sharp edges and corners;
- moving parts that have the potential to cause injury;
- equipment instability;
- flying particles from imploding cathode ray tubes and exploding high pressure lamps.

Examples of measures to reduce risks include:

- rounding of sharp edges and corners;
- guarding;
- provision of SAFETY INTERLOCKS;
- providing sufficient stability to free-standing equipment;
- selecting cathode ray tubes and high pressure lamps that are resistant to implosion and explosion respectively;
- provision of markings to warn USERS where access is unavoidable.

0.2.6 Radiation

Injury to USERS and to SERVICE PERSONS may result from some forms of radiation emitted by equipment. Examples are sonic (acoustic), radio frequency, infra-red, ultraviolet and ionizing radiation, and high intensity visible and coherent light (lasers).

Examples of measures to reduce risks include:

- limiting the energy level of potential radiation sources;
- screening radiation sources;
- provision of SAFETY INTERLOCKS;
- provision of markings to warn USERS where exposure to the radiation hazard is unavoidable.

0.2.7 Chemical hazards

Injury may result from contact with some chemicals or from inhalation of their vapours and fumes.

Examples of measures to reduce risks include:

- avoiding the use of constructional and consumable materials likely to cause injury by contact or inhalation during intended and normal conditions of use;
- avoiding conditions likely to cause leakage or vaporization;
- provision of markings to warn USERS about the hazards.

0.3 Materials and components

Materials and components used in the construction of equipment should be so selected and arranged that they can be expected to perform in a reliable manner for the anticipated life of the equipment without creating a hazard, and would not contribute significantly to the development of a serious fire hazard. Components should be selected so that they remain within their manufacturers' ratings under normal operating conditions, and do not create a hazard under fault conditions.

INFORMATION TECHNOLOGY EQUIPMENT – SAFETY –

Part 1: General requirements

1 General

1.1 Scope

1.1.1 Equipment covered by this standard

This standard is applicable to mains-powered or battery-powered information technology equipment, including electrical business equipment and associated equipment, with a RATED VOLTAGE not exceeding 600 V.

This standard is also applicable to such information technology equipment:

- designed for use as telecommunication terminal equipment and TELECOMMUNICATION NETWORK infrastructure equipment, regardless of the source of power;
- designed and intended to be connected directly to, or used as infrastructure equipment in, a CABLE DISTRIBUTION SYSTEM, regardless of the source of power;
- designed to use the AC MAINS SUPPLY as a communication transmission medium (see Clause 6, Note 4 and 7.1, Note 4).

This standard is also applicable to components and subassemblies intended for incorporation in information technology equipment. It is not expected that such components and subassemblies comply with every aspect of the standard, provided that the complete information technology equipment, incorporating such components and subassemblies, does comply.

NOTE 1 Examples of aspects with which uninstalled components and subassemblies may not comply include the marking of the power rating and access to hazardous parts.

NOTE 2 This standard may be applied to the electronic parts of equipment even if that equipment does not wholly fall within its Scope, such as large-scale air conditioning systems, fire detection systems and fire extinguishing systems. Different requirements may be necessary for some applications.

This standard specifies requirements intended to reduce risks of fire, electric shock or injury for the OPERATOR and layman who may come into contact with the equipment and, where specifically stated, for a SERVICE PERSON.

This standard is intended to reduce such risks with respect to installed equipment, whether it consists of a system of interconnected units or independent units, subject to installing, operating and maintaining the equipment in the manner prescribed by the manufacturer.

Examples of equipment that is in the scope of this standard are:

| Generic product type | Specific example of generic type |
|--|---|
| banking equipment | monetary processing machines including automated teller (cash dispensing) machines (ATM) |
| data and text processing machines and associated equipment | data preparation equipment, data processing equipment, data storage equipment, personal computers, plotters, printers, scanners, text processing equipment, visual display units |
| data network equipment | bridges, data circuit terminating equipment, data terminal equipment, routers |
| electrical and electronic retail equipment | cash registers, point of sale terminals including associated electronic scales |
| electrical and electronic office machines | calculators, copying machines, dictation equipment, document shredding machines, duplicators, erasers, micrographic office equipment, motor-operated files, paper trimmers (punchers, cutting machines, separators), paper jogging machines, pencil sharpeners, staplers, typewriters |
| other information technology equipment | photoprinting equipment, public information terminals, multimedia equipment |
| postage equipment | mail processing machines, postage machines |
| telecommunication network infrastructure equipment | billing equipment, multiplexers, network powering equipment, network terminating equipment, radio basestations, repeaters, transmission equipment, telecommunication switching equipment |
| telecommunication terminal equipment | facsimile equipment, key telephone systems, modems, PABXs, pagers, telephone answering machines, telephone sets (wired and wireless) |

NOTE 3 The requirements of IEC 60065 may also be used to meet safety requirements for multimedia equipment. See IEC Guide 112, *Guide on the safety of multimedia equipment*.

This list is not intended to be comprehensive, and equipment that is not listed is not necessarily excluded from the Scope.

Equipment complying with the relevant requirements in this standard is considered suitable for use with process control equipment, automatic test equipment and similar systems requiring information processing facilities. However, this standard does not include requirements for performance or functional characteristics of equipment.

1.1.2 Additional requirements

Requirements additional to those specified in this standard may be necessary for:

- equipment intended for operation in special environments (for example, extremes of temperature; excessive dust, moisture or vibration; flammable gases; and corrosive or explosive atmospheres);
- electromedical applications with physical connections to the patient;
- equipment intended to be used in vehicles, on board ships or aircraft, in tropical countries, or at altitudes greater than 2 000 m;
- equipment intended for use where ingress of water is possible; for guidance on such requirements and on relevant testing, see Annex T.

NOTE Attention is drawn to the fact that authorities of some countries impose additional requirements.

1.1.3 Exclusions

This standard does not apply to:

- power supply systems which are not an integral part of the equipment, such as motor-generator sets, battery backup systems and transformers;
- building installation wiring;
- devices requiring no electric power.

1.2 Definitions

For the purpose of this International Standard the following definitions apply. Where the terms "voltage" and "current" are used, they imply the r.m.s. values, unless otherwise specified.

Definitions in alphabetical order of nouns

| | |
|---|-----------|
| AREA, OPERATOR ACCESS | 1.2.7.1 |
| AREA, SERVICE ACCESS | 1.2.7.2 |
| BODY | 1.2.7.5 |
| CABLE, INTERCONNECTING | 1.2.11.6 |
| CABLE DISTRIBUTION SYSTEM | 1.2.13.14 |
| CHEESECLOTH | 1.2.13.15 |
| CIRCUIT, ELV | 1.2.8.7 |
| CIRCUIT, LIMITED CURRENT | 1.2.8.9 |
| CIRCUIT, PRIMARY | 1.2.8.4 |
| CIRCUIT, SECONDARY | 1.2.8.5 |
| CIRCUIT, SELV | 1.2.8.8 |
| CIRCUIT, TNV | 1.2.8.11 |
| CIRCUIT, TNV-1 | 1.2.8.12 |
| CIRCUIT, TNV-2 | 1.2.8.13 |
| CIRCUIT, TNV-3 | 1.2.8.14 |
| CLEARANCE | 1.2.10.1 |
| CONDUCTOR, PROTECTIVE BONDING | 1.2.13.11 |
| CONDUCTOR, PROTECTIVE EARTHING | 1.2.13.10 |
| CORD, DETACHABLE POWER SUPPLY | 1.2.5.5 |
| CORD, NON-DETACHABLE POWER SUPPLY | 1.2.5.6 |
| CREEPAGE DISTANCE | 1.2.10.2 |
| CURRENT, PROTECTIVE CONDUCTOR | 1.2.13.13 |
| CURRENT, RATED | 1.2.1.3 |
| CURRENT, TOUCH | 1.2.13.12 |
| CUT-OUT, THERMAL | 1.2.11.3 |
| CUT-OUT, THERMAL, AUTOMATIC RESET | 1.2.11.4 |
| CUT-OUT, THERMAL, MANUAL RESET | 1.2.11.5 |
| EARTHING, FUNCTIONAL | 1.2.13.9 |
| ENCLOSURE | 1.2.6.1 |
| ENCLOSURE, ELECTRICAL | 1.2.6.4 |
| ENCLOSURE, FIRE | 1.2.6.2 |
| ENCLOSURE, MECHANICAL | 1.2.6.3 |
| ENERGY LEVEL, HAZARDOUS | 1.2.8.10 |
| EQUIPMENT, CLASS I | 1.2.4.1 |
| EQUIPMENT, CLASS II | 1.2.4.2 |
| EQUIPMENT, CLASS III | 1.2.4.3 |

| | |
|--|-----------|
| EQUIPMENT, DIRECT PLUG-IN | 1.2.3.6 |
| EQUIPMENT FOR BUILDING-IN | 1.2.3.5 |
| EQUIPMENT, HAND-HELD | 1.2.3.2 |
| EQUIPMENT, MOVABLE | 1.2.3.1 |
| EQUIPMENT, PERMANENTLY CONNECTED | 1.2.5.4 |
| EQUIPMENT, PLUGGABLE | 1.2.5.3 |
| EQUIPMENT, PLUGGABLE, TYPE A | 1.2.5.1 |
| EQUIPMENT, PLUGGABLE, TYPE B | 1.2.5.2 |
| EQUIPMENT, STATIONARY | 1.2.3.4 |
| EQUIPMENT, TRANSPORTABLE | 1.2.3.3 |
| FREQUENCY, RATED | 1.2.1.4 |
| INSULATION, BASIC | 1.2.9.2 |
| INSULATION, DOUBLE | 1.2.9.4 |
| INSULATION, FUNCTIONAL | 1.2.9.1 |
| INSULATION, REINFORCED | 1.2.9.5 |
| INSULATION, SOLID | 1.2.10.4 |
| INSULATION, SUPPLEMENTARY | 1.2.9.3 |
| INTERLOCK, SAFETY | 1.2.7.6 |
| LIMIT, EXPLOSION | 1.2.12.15 |
| LIMITER, TEMPERATURE | 1.2.11.2 |
| LOAD, NORMAL | 1.2.2.1 |
| LOCATION, RESTRICTED ACCESS | 1.2.7.3 |
| MATERIALS, FLAMMABILITY CLASSIFICATION | 1.2.12.1 |
| MATERIAL, 5VA CLASS | 1.2.12.5 |
| MATERIAL, 5VB CLASS | 1.2.12.6 |
| MATERIAL, HB40 CLASS | 1.2.12.10 |
| MATERIAL, HB75 CLASS | 1.2.12.11 |
| MATERIAL, HBF CLASS FOAMED | 1.2.12.9 |
| MATERIAL, HF-1 CLASS FOAMED | 1.2.12.7 |
| MATERIAL, HF-2 CLASS FOAMED | 1.2.12.8 |
| MATERIAL, V-0 CLASS | 1.2.12.2 |
| MATERIAL, V-1 CLASS | 1.2.12.3 |
| MATERIAL, V-2 CLASS | 1.2.12.4 |
| MATERIAL, VTM-0 CLASS | 1.2.12.12 |
| MATERIAL, VTM-1 CLASS | 1.2.12.13 |
| MATERIAL, VTM-2 CLASS | 1.2.12.14 |
| NETWORK, TELECOMMUNICATION | 1.2.13.8 |
| OPERATOR | 1.2.13.7 |
| PART, DECORATIVE | 1.2.6.5 |
| PERSON, SERVICE | 1.2.13.5 |
| RANGE, RATED FREQUENCY | 1.2.1.5 |
| RANGE, RATED VOLTAGE | 1.2.1.2 |
| RATING, PROTECTIVE CURRENT | 1.2.13.17 |
| SUPPLY, AC MAINS | 1.2.8.1 |
| SUPPLY, DC MAINS | 1.2.8.2 |
| SUPPLY, MAINS | 1.2.8.3 |
| SURFACE, BOUNDING | 1.2.10.3 |
| TEST, ROUTINE | 1.2.13.3 |
| TEST, SAMPLING | 1.2.13.2 |
| TEST, TYPE | 1.2.13.1 |
| THERMOSTAT | 1.2.11.1 |

TIME, RATED OPERATING 1.2.2.2

TIME, RATED RESTING 1.2.2.3

TISSUE, WRAPPING 1.2.13.16

TOOL 1.2.7.4

USER 1.2.13.6

VOLTAGE, DC 1.2.13.4

VOLTAGE, HAZARDOUS 1.2.8.6

VOLTAGE, MAINS TRANSIENT 1.2.9.10

VOLTAGE, PEAK WORKING 1.2.9.8

VOLTAGE, RATED 1.2.1.1

VOLTAGE, REQUIRED WITHSTAND 1.2.9.9

VOLTAGE, RMS WORKING 1.2.9.7

VOLTAGE, TELECOMMUNICATION NETWORK TRANSIENT 1.2.9.11

VOLTAGE, WORKING 1.2.9.6

1.2.1 Equipment electrical ratings

1.2.1.1

RATED VOLTAGE

supply voltage (for a three-phase AC MAINS SUPPLY, the line-to-line voltage) as declared by the manufacturer

1.2.1.2

RATED VOLTAGE RANGE

supply voltage range as declared by the manufacturer, expressed by its lower and upper RATED VOLTAGES

1.2.1.3

RATED CURRENT

input current of the equipment as declared by the manufacturer

1.2.1.4

RATED FREQUENCY

supply frequency as declared by the manufacturer

1.2.1.5

RATED FREQUENCY RANGE

supply frequency range as declared by the manufacturer, expressed by its lower and upper RATED FREQUENCIES

1.2.2 Operating conditions

1.2.2.1

NORMAL LOAD

mode of operation, used for testing purposes, which represents as closely as possible the most severe conditions of normal use which can reasonably be expected

If the conditions of actual use can reasonably be expected to be more severe than the maximum load conditions recommended by the manufacturer, including RATED OPERATING TIME and RATED RESTING TIME, a mode of operation is used that represents these more severe conditions.

NOTE NORMAL LOAD conditions for some types of equipment are given in Annex L.

1.2.2.2**RATED OPERATING TIME**

maximum operating time assigned to the equipment by the manufacturer

1.2.2.3**RATED RESTING TIME**

minimum time, assigned by the manufacturer, during which the equipment is switched off or running idle between periods of RATED OPERATING TIME

1.2.3 Equipment mobility**1.2.3.1****MOVABLE EQUIPMENT**

equipment which is either:

- 18 kg or less in mass and not fixed; or
- equipment with wheels, castors or other means to facilitate movement by the OPERATOR as required to perform its intended use

1.2.3.2**HAND-HELD EQUIPMENT**

MOVABLE EQUIPMENT, or a part of any kind of equipment, that is intended to be held in the hand during normal use

1.2.3.3**TRANSPORTABLE EQUIPMENT**

MOVABLE EQUIPMENT that is intended to be routinely carried by a USER

NOTE Examples include laptop and notebook personal computers, pen-based tablet computers, and their portable accessories such as printers and CD-ROM drives.

1.2.3.4**STATIONARY EQUIPMENT**

equipment that is not MOVABLE EQUIPMENT

1.2.3.5**EQUIPMENT FOR BUILDING-IN**

equipment intended to be installed in a prepared recess, such as in a wall, or similar situation

NOTE In general, EQUIPMENT FOR BUILDING-IN does not have an ENCLOSURE on all sides, as some of the sides will be protected after installation.

1.2.3.6**DIRECT PLUG-IN EQUIPMENT**

equipment that is intended to be used without a power supply cord; the mains plug forms an integral part of the equipment ENCLOSURE so that the weight of the equipment is taken by the socket-outlet

1.2.4 Classes of equipment – Protection against electric shock

NOTE Some information technology equipment cannot be identified as conforming to one of the following classes.

1.2.4.1**CLASS I EQUIPMENT**

equipment where protection against electric shock is achieved by

- using BASIC INSULATION and

- providing a means of connection to the PROTECTIVE EARTHING CONDUCTOR in the building wiring those conductive parts that are otherwise capable of assuming HAZARDOUS VOLTAGES if the BASIC INSULATION fails

NOTE CLASS I EQUIPMENT may have parts with DOUBLE INSULATION or REINFORCED INSULATION.

1.2.4.2

CLASS II EQUIPMENT

equipment in which protection against electric shock does not rely on BASIC INSULATION only, but in which additional safety precautions, such as DOUBLE INSULATION or REINFORCED INSULATION are provided, there being no reliance on protective earthing

1.2.4.3

CLASS III EQUIPMENT

equipment in which protection against electric shock relies upon supply from SELV CIRCUITS and in which HAZARDOUS VOLTAGES are not generated

NOTE For CLASS III EQUIPMENT, although there is no requirement for protection against electric shock, all other requirements of the standard apply.

1.2.5 Connection to the supply

1.2.5.1

PLUGGABLE EQUIPMENT TYPE A

equipment that is intended for connection to a MAINS SUPPLY via a non-industrial plug and socket-outlet or a non-industrial appliance coupler, or both

1.2.5.2

PLUGGABLE EQUIPMENT TYPE B

equipment that is intended for connection to a MAINS SUPPLY via an industrial plug and socket-outlet or an appliance coupler, or both, complying with IEC 60309 or with a comparable national standard

1.2.5.3

PLUGGABLE EQUIPMENT

equipment that is either PLUGGABLE EQUIPMENT TYPE A or PLUGGABLE EQUIPMENT TYPE B

1.2.5.4

PERMANENTLY CONNECTED EQUIPMENT

equipment that is intended for connection to the building installation wiring using screw terminals or other reliable means

1.2.5.5

DETACHABLE POWER SUPPLY CORD

flexible cord, for supply purposes, intended to be connected to the equipment by means of a suitable appliance coupler

1.2.5.6

NON-DETACHABLE POWER SUPPLY CORD

flexible cord, for supply purposes, fixed to or assembled with the equipment

Such a cord may be either:

Ordinary: a flexible cord that can be easily replaced without special preparation of the cord or special TOOLS; or

Special: a flexible cord that is specially prepared, or requires the use of specially designed TOOLS for replacement, or is such that it cannot be replaced without damage to the equipment.

The term "specially prepared" includes provision of an integral cord guard, the use of cable lugs, formation of eyelets, etc., but not the reshaping of the conductor before introduction into a terminal or the twisting of a stranded conductor to consolidate the end.

1.2.6 Enclosures

1.2.6.1

ENCLOSURE

part of the equipment providing one or more of the functions described in 1.2.6.2, 1.2.6.3 or 1.2.6.4

NOTE One type of ENCLOSURE can be inside another type (for example, an ELECTRICAL ENCLOSURE inside a FIRE ENCLOSURE or a FIRE ENCLOSURE inside an ELECTRICAL ENCLOSURE). Also, a single ENCLOSURE can provide the functions of more than one type (for example, the functions of both an ELECTRICAL ENCLOSURE and a FIRE ENCLOSURE).

1.2.6.2

FIRE ENCLOSURE

part of the equipment intended to minimize the spread of fire or flames from within

1.2.6.3

MECHANICAL ENCLOSURE

part of the equipment intended to reduce the risk of injury due to mechanical and other physical hazards

1.2.6.4

ELECTRICAL ENCLOSURE

part of the equipment intended to limit access to parts that may be at HAZARDOUS VOLTAGES or HAZARDOUS ENERGY LEVELS or are in TNV CIRCUITS

1.2.6.5

DECORATIVE PART

part of the equipment, outside the ENCLOSURE, which has no safety function

1.2.7 Accessibility

1.2.7.1

OPERATOR ACCESS AREA

part of the equipment to which, under normal operating conditions, one of the following applies:

- access can be gained without the use of a TOOL;
- the means of access is deliberately provided to the OPERATOR;
- the OPERATOR is instructed to enter regardless of whether or not a TOOL is needed to gain access

The terms "access" and "accessible", unless qualified, relate to an OPERATOR ACCESS AREA as defined above.

1.2.7.2

SERVICE ACCESS AREA

part of the equipment, other than an OPERATOR ACCESS AREA, where it is necessary for SERVICE PERSONS to have access even with the equipment switched on

1.2.7.3

RESTRICTED ACCESS LOCATION

location for equipment where both of the following apply:

- access can only be gained by SERVICE PERSONS or by USERS who have been instructed about the reasons for the restrictions applied to the location and about any precautions that shall be taken; and
- access is through the use of a TOOL or lock and key, or other means of security, and is controlled by the authority responsible for the location

NOTE The requirements for equipment intended for installation in RESTRICTED ACCESS LOCATIONS are the same as for OPERATOR ACCESS AREAS, except as given in 1.7.14, 2.1.3, 4.5.4, 4.6.2 and 5.1.7.

1.2.7.4

TOOL

screwdriver or any other object that may be used to operate a screw, latch or similar fixing means

1.2.7.5

BODY

all accessible conductive parts, shafts of handles, knobs, grips and the like, and metal foil in contact with all accessible surfaces of insulating material

1.2.7.6

SAFETY INTERLOCK

means either of preventing access to a hazardous area until the hazard is removed, or of automatically removing the hazardous condition when access is gained

1.2.8 Circuits and circuit characteristics

1.2.8.1

AC MAINS SUPPLY

a.c. power distribution system external to the equipment for supplying power to a.c. powered equipment

These power sources include public or private utilities and, unless otherwise specified in the standard (for example, 1.4.5), equivalent sources such as motor-driven generators and uninterruptible power supplies.

NOTE See Annex V for typical examples of a.c. power distribution systems.

1.2.8.2

DC MAINS SUPPLY

d.c. power distribution system, with or without batteries, external to the equipment, for supplying power to d.c. powered equipment, excluding the following:

- a d.c. supply providing power over TELECOMMUNICATION NETWORK wiring to remote equipment;
- a limited power source (see 2.5) whose open circuit voltage is less than or equal to 42,4 V d.c.;
- a d.c. supply whose open circuit voltage is greater than 42,4 V d.c. and less than or equal to 60 V d.c., and whose available power output is less than 240 VA

Circuitry connected to a DC MAINS SUPPLY is considered to be a SECONDARY CIRCUIT (for example, an SELV CIRCUIT, a TNV CIRCUIT or a HAZARDOUS VOLTAGE SECONDARY CIRCUIT) in the meaning of this standard.

NOTE See ITU-T Recommendation K.27 for bonding configurations and earthing inside a telecommunication building.

1.2.8.3

MAINS SUPPLY

power distribution system that is either an AC MAINS SUPPLY or a DC MAINS SUPPLY

1.2.8.4

PRIMARY CIRCUIT

circuit that is directly connected to the AC MAINS SUPPLY

It includes, for example, the means for connection to the AC MAINS SUPPLY, the primary windings of transformers, motors and other loading devices.

NOTE Conductive parts of an INTERCONNECTING CABLE may be part of a PRIMARY CIRCUIT as stated in 1.2.11.6.

1.2.8.5

SECONDARY CIRCUIT

circuit that has no direct connection to a PRIMARY CIRCUIT and derives its power from a transformer, converter or equivalent isolation device, or from a battery

NOTE Conductive parts of an INTERCONNECTING CABLE may be part of a SECONDARY CIRCUIT as stated in 1.2.11.6.

1.2.8.6

HAZARDOUS VOLTAGE

voltage exceeding 42,4 V peak, or 60 V d.c., existing in a circuit that does not meet the requirements for either a LIMITED CURRENT CIRCUIT or a TNV CIRCUIT

1.2.8.7

ELV CIRCUIT

SECONDARY CIRCUIT with voltages between any two conductors of the circuit, and between any one such conductor and earth (see 1.4.9), not exceeding 42,4 V peak, or 60 V d.c., under normal operating conditions, which is separated from HAZARDOUS VOLTAGE by BASIC INSULATION, and which neither meets all of the requirements for an SELV CIRCUIT nor meets all of the requirements for a LIMITED CURRENT CIRCUIT

1.2.8.8

SELV CIRCUIT

SECONDARY CIRCUIT that is so designed and protected that under normal operating conditions and single fault conditions, its voltages do not exceed a safe value

NOTE 1 The limit values of voltages under normal operating conditions and single fault conditions (see 1.4.14) are specified in 2.2. See also Table 1A.

NOTE 2 This definition of an SELV CIRCUIT differs from the term "SELV system" as used in IEC 61140.

1.2.8.9

LIMITED CURRENT CIRCUIT

circuit that is so designed and protected that, under both normal operating conditions and single fault conditions, the current that can be drawn is not hazardous

NOTE The limit values of currents under normal operating conditions and single fault conditions (see 1.4.14) are specified in 2.4.

1.2.8.10

HAZARDOUS ENERGY LEVEL

available power level of 240 VA or more, having a duration of 60 s or more, or a stored energy level of 20 J or more (for example, from one or more capacitors), at a potential of 2 V or more

1.2.8.11

TNV CIRCUIT

circuit that is in the equipment and to which the accessible area of contact is limited and that is so designed and protected that, under normal operating conditions and single fault conditions (see 1.4.14), the voltages do not exceed specified limit values

A TNV CIRCUIT is considered to be a SECONDARY CIRCUIT in the meaning of this standard.

NOTE 1 The specified limit values of voltages under normal operating conditions and single fault conditions (see 1.4.14) are given in 2.3.1. Requirements regarding accessibility of TNV CIRCUITS are given in 2.1.1.1.

NOTE 2 Conductive parts of an INTERCONNECTING CABLE may be part of a TNV CIRCUIT as stated in 1.2.11.6.

TNV CIRCUITS are classified as TNV-1 CIRCUITS, TNV-2 CIRCUITS and TNV-3 CIRCUITS as defined in 1.2.8.12, 1.2.8.13 and 1.2.8.14.

NOTE 3 The voltage relationships between SELV and TNV CIRCUITS are shown in Table 1A.

Table 1A – Voltage ranges of SELV and TNV circuits

| Overvoltages from TELECOMMUNICATION NETWORKS possible? | Overvoltages from CABLE DISTRIBUTION SYSTEMS possible ? | Normal operating voltages | |
|--|---|----------------------------|---|
| | | Within SELV CIRCUIT limits | Exceeding SELV CIRCUIT limits but within TNV CIRCUIT limits |
| Yes | Yes | TNV-1 CIRCUIT | TNV-3 CIRCUIT |
| No | Not applicable | SELV CIRCUIT | TNV-2 CIRCUIT |

1.2.8.12

TNV-1 CIRCUIT

TNV CIRCUIT

- whose normal operating voltages do not exceed the limits for an SELV CIRCUIT under normal operating conditions and
- on which overvoltages from TELECOMMUNICATION NETWORKS and CABLE DISTRIBUTION SYSTEMS are possible

1.2.8.13

TNV-2 CIRCUIT

TNV CIRCUIT

- whose normal operating voltages exceed the limits for an SELV CIRCUIT under normal operating conditions and
- which is not subject to overvoltages from TELECOMMUNICATION NETWORKS

1.2.8.14

TNV-3 CIRCUIT

TNV CIRCUIT

- whose normal operating voltages exceed the limits for an SELV CIRCUIT under normal operating conditions and

- on which overvoltages from TELECOMMUNICATION NETWORKS and CABLE DISTRIBUTION SYSTEMS are possible

1.2.9 Insulation

1.2.9.1

FUNCTIONAL INSULATION

insulation that is necessary only for the correct functioning of the equipment

NOTE FUNCTIONAL INSULATION by definition does not protect against electric shock. It may, however, reduce the likelihood of ignition and fire.

1.2.9.2

BASIC INSULATION

insulation to provide basic protection against electric shock

1.2.9.3

SUPPLEMENTARY INSULATION

independent insulation applied in addition to BASIC INSULATION in order to reduce the risk of electric shock in the event of a failure of the BASIC INSULATION

1.2.9.4

DOUBLE INSULATION

insulation comprising both BASIC INSULATION and SUPPLEMENTARY INSULATION

1.2.9.5

REINFORCED INSULATION

single insulation system that provides a degree of protection against electric shock equivalent to DOUBLE INSULATION under the conditions specified in this standard

NOTE The term "insulation system" does not imply that the insulation has to be in one homogeneous piece. It may comprise several layers that cannot be tested as BASIC INSULATION and SUPPLEMENTARY INSULATION.

1.2.9.6

WORKING VOLTAGE

highest voltage to which the insulation or the component under consideration is, or can be, subjected when the equipment is operating under conditions of normal use

Overvoltages that originate outside the equipment are not taken into account.

1.2.9.7

RMS WORKING VOLTAGE

r.m.s. value of a WORKING VOLTAGE, including any d.c. component

NOTE For the purpose of determining RMS WORKING VOLTAGES, the rules of 2.10.2.2 apply, and where relevant those of 1.4.8.

1.2.9.8

PEAK WORKING VOLTAGE

peak value of a WORKING VOLTAGE, including any d.c. component and any repetitive peak impulses generated in the equipment

Where peak-to-peak ripple exceeds 10 % of the average value, the requirements related to peak or a.c. voltages are applicable.

NOTE For the purpose of determining PEAK WORKING VOLTAGES, the rules of 2.10.2.3 apply, and where relevant those of 1.4.8.

1.2.9.9

REQUIRED WITHSTAND VOLTAGE

peak voltage that the insulation under consideration is required to withstand

1.2.9.10

MAINS TRANSIENT VOLTAGE

highest peak voltage expected at the power input to the equipment, arising from external transients on the MAINS SUPPLY

1.2.9.11

TELECOMMUNICATION NETWORK TRANSIENT VOLTAGE

highest peak voltage expected at the TELECOMMUNICATION NETWORK connection point of the equipment, arising from external transients on the network

NOTE The effect of transients from CABLE DISTRIBUTION SYSTEMS is not taken into account.

1.2.10 Properties of insulation

1.2.10.1

CLEARANCE

shortest distance between two conductive parts, or between a conductive part and the BOUNDING SURFACE of the equipment, measured through air

1.2.10.2

CREEPAGE DISTANCE

shortest path between two conductive parts, or between a conductive part and the BOUNDING SURFACE of the equipment, measured along the surface of the insulation

1.2.10.3

BOUNDING SURFACE

outer surface of the ELECTRICAL ENCLOSURE, considered as though metal foil were pressed into contact with accessible surfaces of insulating material

1.2.10.4

SOLID INSULATION

material that provides electrical insulation between two opposite surfaces, not along an outer surface

NOTE The required properties of SOLID INSULATION are specified either as

- the actual minimum distance through the insulation (see 2.10.5.2), or by
- other requirements and tests in this standard instead of a minimum distance.

1.2.11 Components

1.2.11.1

THERMOSTAT

cycling temperature-sensing control intended to keep a temperature between two particular values under normal operating conditions and that may have provision for setting by the OPERATOR

1.2.11.2

TEMPERATURE LIMITER

temperature-sensing control intended to keep a temperature below or above one particular value during normal operating conditions and that may have provision for setting by the OPERATOR

NOTE A TEMPERATURE LIMITER may be of the automatic reset or of the manual reset type.

1.2.11.3

THERMAL CUT-OUT

temperature-sensing control intended to operate under abnormal operating conditions and that has no provision for the OPERATOR to change the temperature setting

NOTE A THERMAL CUT-OUT may be of the automatic reset or of the manual reset type.

1.2.11.4

THERMAL CUT-OUT, AUTOMATIC RESET

THERMAL CUT-OUT that automatically restores the current after the relevant part of the equipment has cooled down sufficiently

1.2.11.5

THERMAL CUT-OUT, MANUAL RESET

THERMAL CUT-OUT that requires resetting by hand, or replacement of a part, in order to restore the current

1.2.11.6

INTERCONNECTING CABLE

cable used to

- electrically connect an accessory to a unit of information technology equipment,
- interconnect units in a system, or
- connect a unit to a TELECOMMUNICATION NETWORK or to a CABLE DISTRIBUTION SYSTEM

Such a cable may carry any type of circuit from one unit to another.

NOTE A power supply cord for connection to the MAINS SUPPLY is not an INTERCONNECTING CABLE.

1.2.12 Flammability

1.2.12.1

FLAMMABILITY CLASSIFICATION OF MATERIALS

recognition of the burning behaviour of materials and their ability to extinguish if ignited

Materials are classified as in 1.2.12.2 to 1.2.12.14 when tested in accordance with IEC 60695-11-10, IEC 60695-11-20, ISO 9772 or ISO 9773.

NOTE 1 When applying the requirements in this standard, HF-1 CLASS FOAMED MATERIAL is regarded as better than HF-2 CLASS, and HF-2 CLASS better than HBF CLASS.

NOTE 2 Similarly, material of 5VA CLASS is regarded as better than 5VB CLASS, 5VB CLASS better than V-0 CLASS, V-0 CLASS better than V-1 CLASS, V-1 CLASS better than V-2 CLASS, V-2 CLASS better than HB40 CLASS and HB40 CLASS better than HB75 CLASS.

NOTE 3 Similarly, MATERIAL of VTM-0 CLASS is regarded as better than VTM-1 CLASS and VTM-1 CLASS better than VTM-2 CLASS.

NOTE 4 VTM-0 CLASS, VTM-1 CLASS and VTM-2 CLASS MATERIALS are considered to be equivalent to V-0 CLASS, V-1 CLASS and V-2 CLASS MATERIALS, respectively, but only for their flammability properties. Their electrical and mechanical properties are not necessarily equivalent.

NOTE 5 Certain flammability classes have replaced the classes used in earlier editions of this standard. The equivalence of the old and the new classes is shown in Table 1B.

Table 1B – Equivalence of flammability classes

| Old class | New class | Equivalence |
|-----------|---------------------|---|
| - | 5VA (1.2.12.5) | 5VA is not required in this standard. |
| 5V | 5VB (1.2.12.6) | Materials that pass the tests for class 5V in Clause A.9 of earlier editions of this standard are equivalent to 5VB or better. |
| HB | HB40 (1.2.12.10) | Samples of materials in a thickness of 3 mm that pass the tests of Clause A.8 in earlier editions of this standard (maximum burning rate 40 mm/min during test) are equivalent to HB40. |
| | HB75 (1.2.12.11) | Samples of materials in a thickness of less than 3 mm that pass the tests of Clause A.8 in earlier editions of this standard (maximum burning rate 75 mm/min during test) are equivalent to HB75. |

1.2.12.2

V-0 CLASS MATERIAL

material tested in the thinnest significant thickness used and classified v-0 according to IEC 60695-11-10

1.2.12.3

V-1 CLASS MATERIAL

material tested in the thinnest significant thickness used and classified v-1 according to IEC 60695-11-10

1.2.12.4

V-2 CLASS MATERIAL

material tested in the thinnest significant thickness used and classified v-2 according to IEC 60695-11-10

1.2.12.5

5VA CLASS MATERIAL

material tested in the thinnest significant thickness used and classified 5VA according to IEC 60695-11-20

1.2.12.6

5VB CLASS MATERIAL

material tested in the thinnest significant thickness used and classified 5VB according to IEC 60695-11-20

1.2.12.7

HF-1 CLASS FOAMED MATERIAL

foamed material tested in the thinnest significant thickness used and classified HF-1 according to ISO 9772

1.2.12.8

HF-2 CLASS FOAMED MATERIAL

foamed material tested in the thinnest significant thickness used and classified HF-2 according to ISO 9772

1.2.12.9

HBF CLASS FOAMED MATERIAL

foamed material tested in the thinnest significant thickness used and classified HBF according to ISO 9772

1.2.12.10**HB40 CLASS MATERIAL**

material tested in the thinnest significant thickness used and classified HB40 according to IEC 60695-11-10

1.2.12.11**HB75 CLASS MATERIAL**

material tested in the thinnest significant thickness used and classified HB75 according to IEC 60695-11-10

1.2.12.12**VTM-0 CLASS MATERIAL**

material tested in the thinnest significant thickness used and classified VTM-0 according to ISO 9773

1.2.12.13**VTM-1 CLASS MATERIAL**

material tested in the thinnest significant thickness used and classified VTM-1 according to ISO 9773

1.2.12.14**VTM-2 CLASS MATERIAL**

material tested in the thinnest significant thickness used and classified VTM-2 according to ISO 9773

1.2.12.15**EXPLOSION LIMIT**

lowest concentration of a combustible material in a mixture containing any of the following: gases, vapours, mists or dusts, in which a flame is able to propagate after removal of the ignition source

1.2.13 Miscellaneous**1.2.13.1****TYPE TEST**

test on a representative sample with the objective of determining if, as designed and manufactured, it can meet the requirements of this standard

1.2.13.2**SAMPLING TEST**

test on a number of samples taken at random from a batch

1.2.13.3**ROUTINE TEST**

test to which each individual sample is subjected during or after manufacture to check if the sample complies with certain criteria

1.2.13.4**DC VOLTAGE**

average value of a voltage having a peak-to-peak ripple not exceeding 10 % of the average value

NOTE Where peak-to-peak ripple exceeds 10 % of the average value, the requirements related to peak voltage are applicable.

1.2.13.5

SERVICE PERSON

person having appropriate technical training and experience necessary to be aware of hazards to which that person may be exposed in performing a task and of measures to minimize the risks to that person or other persons

1.2.13.6

USER

any person, other than a SERVICE PERSON

The term USER in this standard is the same as the term OPERATOR and the two terms can be interchanged.

1.2.13.7

OPERATOR

see USER (1.2.13.6)

1.2.13.8

TELECOMMUNICATION NETWORK

metallically terminated transmission medium intended for communication between equipment that may be located in separate buildings, excluding:

- the mains system for supply, transmission and distribution of electrical power, if used as a telecommunication transmission medium;
- CABLE DISTRIBUTION SYSTEMS;
- SELV CIRCUITS connecting units of information technology equipment

NOTE 1 The term TELECOMMUNICATION NETWORK is defined in terms of its functionality, not its electrical characteristics. A TELECOMMUNICATION NETWORK is not itself defined as being either an SELV CIRCUIT or a TNV CIRCUIT. Only the circuits in the equipment are so classified.

NOTE 2 A TELECOMMUNICATION NETWORK may be:

- publicly or privately owned;
- subject to transient overvoltages due to atmospheric discharges and faults in power distribution systems;
- subject to longitudinal (common mode) voltages induced from nearby power lines or electric traction lines.

NOTE 3 Examples of TELECOMMUNICATION NETWORKS are:

- a public switched telephone network;
- a public data network;
- an Integrated Services Digital Network (ISDN);
- a private network with electrical interface characteristics similar to the above.

1.2.13.9

FUNCTIONAL EARTHING

earthing of a point in equipment or in a system, which is necessary for a purpose other than safety

1.2.13.10

PROTECTIVE EARTHING CONDUCTOR

conductor in the building installation wiring, or in the power supply cord, connecting a main protective earthing terminal in the equipment to an earth point in the building installation

NOTE In some countries, the term "grounding conductor" is used instead of "PROTECTIVE EARTHING CONDUCTOR".

1.2.13.11**PROTECTIVE BONDING CONDUCTOR**

conductor in the equipment, or a combination of conductive parts in the equipment, connecting a main protective earthing terminal to a part of the equipment that is required to be earthed for safety purposes

1.2.13.12**TOUCH CURRENT**

electric current through a human body when it touches one or more accessible parts

NOTE TOUCH CURRENT was previously included in the term "leakage current".

1.2.13.13**PROTECTIVE CONDUCTOR CURRENT**

current flowing through the PROTECTIVE EARTHING CONDUCTOR under normal operating conditions

NOTE PROTECTIVE CONDUCTOR CURRENT was previously included in the term "leakage current".

1.2.13.14**CABLE DISTRIBUTION SYSTEM**

metallically terminated transmission medium using coaxial cable, mainly intended for transmission of video and/or audio signals between separate buildings or between outdoor antennas and buildings, excluding:

- the mains system for supply, transmission and distribution of electric power, if used as a communication transmission medium;
- TELECOMMUNICATION NETWORKS;
- SELV CIRCUITS connecting units of information technology equipment

NOTE 1 Examples of CABLE DISTRIBUTION SYSTEMS are:

- local area cable networks, community antenna television systems and master antenna television systems providing video and audio signal distribution;
- outdoor antennas including satellite dishes, receiving antennas, and other similar devices.

NOTE 2 CABLE DISTRIBUTION SYSTEMS may be subjected to greater transients than TELECOMMUNICATION NETWORKS (see 7.4.1).

1.2.13.15**CHEESE CLOTH**

bleached cotton cloth of approximately 40 g/m²

1.2.13.16**WRAPPING TISSUE**

soft and strong, lightweight wrapping paper of grammage generally between 12 g/m² and 30 g/m², primarily intended for protective packaging of delicate articles and for gift wrapping

[ISO 4046-4:2002, definition 4.215]

1.2.13.17**PROTECTIVE CURRENT RATING**

rating of an overcurrent protective device that is known or assumed to be in place to protect a circuit

NOTE Rules to determine the value of the PROTECTIVE CURRENT RATING are in 2.6.3.3.

1.3 General requirements

1.3.1 Application of requirements

The requirements detailed in this standard shall be applied only if safety is involved.

In order to establish whether or not safety is involved, the circuits and construction shall be carefully investigated to take into account the consequences of possible failures.

1.3.2 Equipment design and construction

Equipment shall be so designed and constructed that, under all conditions of normal use and under likely abnormal use or single fault conditions (see 1.4.14), protection is provided to reduce the risk of personal injury from electric shock and other hazards, and against spread of fire originating in the equipment.

Compliance is checked by inspection and by the relevant tests.

1.3.3 Supply voltage

Equipment shall be designed to be safe at any supply voltage to which it is intended to be connected.

Compliance is checked by inspection and by carrying out the relevant tests of this standard using a supply voltage as specified in the corresponding subclause. If the subclause does not specify the supply voltage (explicitly or by reference to 1.4.5), then the value of the RATED VOLTAGE or any value in the RATED VOLTAGE RANGE shall be used.

1.3.4 Constructions not specifically covered

Where the equipment involves technologies and materials or methods of construction not specifically covered in this standard, the equipment shall provide a level of safety not less than that generally afforded by this standard and the principles of safety contained herein.

NOTE The need for additional detailed requirements to cope with a new situation should be brought promptly to the attention of the appropriate committee.

1.3.5 Equivalent materials

Where the standard specifies a particular grade of insulation, the use of a better grade of insulation is permitted. Similarly, where the standard requires material of a particular FLAMMABILITY CLASS, the use of a better class is permitted.

1.3.6 Orientation during transport and use

Where it is clear that the orientation of the equipment is likely to have a significant effect on the application of the requirements or the results of tests, all orientations of use permitted in the installation or operating instructions shall be taken into account. For TRANSPORTABLE EQUIPMENT, all orientations of transport and use shall be taken into account.

NOTE The above may apply to 4.1, 4.2, 4.3.8, 4.5, 4.6 and 5.3.

1.3.7 Choice of criteria

Where the standard permits a choice between different criteria for compliance, or between different methods or conditions of test, the choice is specified by the manufacturer.

1.3.8 Examples mentioned in the standard

Where examples of equipment, parts, methods of construction, design techniques and faults are given in the standard, prefaced by "for example" or "such as", other examples, situations and solutions are not excluded.

1.3.9 Conductive liquids

For the electrical requirements of this standard, conductive liquids shall be treated as conductive parts.

☐ 1.3.Z1 Exposure to excessive sound pressure

The apparatus shall be so designed and constructed as to present no danger when used for its intended purpose, either in normal operating conditions or under fault conditions, particularly providing protection against exposure to excessive sound pressures from headphones or earphones.

NOTE Z1 A new method of measurement is described in EN 50332-1, Sound system equipment: Headphones and earphones associated with portable audio equipment - Maximum sound pressure level measurement methodology and limit considerations - Part 1: General method for "one package equipment", and in EN 50332-2, Sound system equipment: Headphones and earphones associated with portable audio equipment - Maximum sound pressure level measurement methodology and limit considerations - Part 2: Guidelines to associate sets with headphones coming from different manufacturers: ☐

1.4 General conditions for tests

1.4.1 Application of tests

The tests detailed in this standard shall be conducted only if safety is involved.

If it is evident from the design and construction of the equipment that a particular test is not applicable, the test is not made.

Unless otherwise stated, upon conclusion of the tests, the equipment need not be operational.

1.4.2 Type tests

Except where otherwise stated, the tests specified in this standard are TYPE TESTS.

1.4.3 Test samples

Unless otherwise specified, the sample or samples under test shall be representative of the equipment the USER would receive, or shall be the actual equipment ready for shipment to the USER.

As an alternative to carrying out tests on the complete equipment, tests may be conducted separately on circuits, components or subassemblies outside the equipment, provided that inspection of the equipment and circuit arrangements indicates that the results of such testing will be representative of the results of testing the assembled equipment. If any such test indicates a likelihood of non-conformance in the complete equipment, the test shall be repeated in the equipment.

If a test specified in this standard could be destructive, it is permitted to use a model to represent the condition to be evaluated.

NOTE 1 The tests should be conducted in the following order:

- component or material pre-selection;
- component or subassembly bench tests;
- tests where the equipment is not energized;
- live tests:
 - under normal operating conditions;
 - under abnormal operating conditions;
 - involving likely destruction.

NOTE 2 In view of the resources involved in testing and in order to minimize waste, it is recommended that all parties concerned jointly consider the test programme, the test samples and the test sequence.

1.4.4 Operating parameters for tests

Except where specific test conditions are stated elsewhere in the standard and where it is clear that there is a significant impact on the results of the test, the tests shall be conducted under the most unfavourable combination within the manufacturer's operating specifications of the following parameters:

- supply voltage (see 1.4.5);
- supply frequency (see 1.4.6);
- operating temperature (see 1.4.12);
- physical location of equipment and position of movable parts;
- operating mode;
- adjustment of THERMOSTATS, regulating devices or similar controls in OPERATOR ACCESS AREAS, which are:
 - adjustable without the use of a TOOL; or
 - adjustable using a means, such as a key or a TOOL, deliberately provided for the OPERATOR.

1.4.5 Supply voltage for tests

In determining the most unfavourable voltage for the power to energize the equipment under test (EUT), the following variables shall be taken into account:

- multiple RATED VOLTAGES;
- tolerances on RATED VOLTAGE as specified below;
- extremes of RATED VOLTAGE RANGES.

If the equipment is intended for direct connection to an AC MAINS SUPPLY, the tolerances on RATED VOLTAGE shall be taken as +6 % and –10 %, unless:

- the RATED VOLTAGE is 230 V single-phase or 400 V three-phase, in which case the tolerance shall be taken as +10 % and –10 %; or
- a wider tolerance is declared by the manufacturer, in which case the tolerance shall be taken as this wider value.

If the equipment is intended only for connection to an a.c. mains equivalent source, such as a motor-driven generator or an uninterruptible power supply (see 1.2.8.1), or a source other than a MAINS SUPPLY, the tolerances on RATED VOLTAGE shall be declared by the manufacturer.

If equipment is intended for connection to a DC MAINS SUPPLY, the tolerance shall be taken as +20 % and –15 %, unless declared otherwise by the manufacturer.

When testing equipment designed for d.c. only, the possible influence of polarity shall be taken into account.

1.4.6 Supply frequency for tests

In determining the most unfavourable frequency for the power to energize the EUT, different RATED FREQUENCIES within the RATED FREQUENCY RANGE shall be taken into account (for example, 50 Hz and 60 Hz) but consideration of the tolerance on a RATED FREQUENCY (for example, 50 Hz \pm 0,5 Hz) is not normally necessary.

1.4.7 Electrical measuring instruments

Electrical measuring instruments shall have adequate bandwidth to provide accurate readings, taking into account all components (d.c., AC MAINS SUPPLY frequency, high frequency and harmonic content) of the parameter being measured. If the r.m.s. value is measured, care shall be taken that measuring instruments give true r.m.s. readings of non-sinusoidal waveforms as well as sinusoidal waveforms.

1.4.8 Normal operating voltages

For the purposes of:

- determining WORKING VOLTAGES (see 1.2.9.6); and
- classifying circuits in the equipment as ELV CIRCUITS, SELV CIRCUITS, TNV-1 CIRCUITS, TNV-2 CIRCUITS, TNV-3 CIRCUITS, or HAZARDOUS VOLTAGE circuits;



the following voltages shall be considered:

- normal operating voltages generated in the equipment, including repetitive peak voltages such as those associated with switch mode power supplies;
- normal operating voltages generated outside the equipment, including ringing signals received from TELECOMMUNICATION NETWORKS.

For these purposes, unwanted, externally generated, non-repetitive transient voltages (for example, MAINS TRANSIENT VOLTAGES and TELECOMMUNICATION NETWORK TRANSIENT VOLTAGES) induced by power distribution system switching and lightning surges, shall not be considered:

- when determining WORKING VOLTAGES, because such transients have been taken into account in the procedures for determining minimum CLEARANCES (see 2.10.3 and Annex G);
- when classifying circuits in the equipment, except when distinguishing between SELV CIRCUITS and TNV-1 CIRCUITS and between TNV-2 CIRCUITS and TNV-3 CIRCUITS (see 1.2.8.11, Table 1A).

NOTE 1 The effects of unwanted steady-state voltages generated outside the equipment (for example, earth potential differences and voltages induced on TELECOMMUNICATION NETWORKS by electric train systems) are controlled by installation practices or by appropriate isolation in the equipment. Such measures are application dependent and are not dealt with by this standard.

 Note deleted 

1.4.9 Measurement of voltage to earth

Where the standard specifies a voltage between a conductive part and earth, all of the following earthed parts are considered:

- the main protective earthing terminal (if any); and
- any other conductive part required to be connected to protective earth (for examples see 2.6.1); and
- any conductive part that is earthed within the equipment for functional reasons.

Parts that will be earthed in the application by connection to other equipment, but are unearthed in the equipment as tested, shall be connected to earth at the point by which the highest voltage is obtained. When measuring a voltage between earth and a conductor in a circuit that will not be earthed in the intended application of the equipment, a non-inductive resistor of $5\,000\ \Omega \pm 10\%$ shall be connected across the voltage measuring instrument.

Voltage drop in the PROTECTIVE EARTHING CONDUCTOR of the power supply cord, or in an earthed conductor in other external wiring, is not included in the measurements.

1.4.10 Loading configuration of the EUT

In determining the input current (see 1.6.2), and where other test results could be affected, the following variables shall be considered and adjusted to give the most unfavourable results:

- loads due to optional features, offered or provided by the manufacturer for inclusion in or with the EUT;
- loads due to other units of equipment intended by the manufacturer to draw power from the EUT;
- loads that could be connected to any standard supply outlets in OPERATOR ACCESS AREAS on the equipment, up to the value indicated in the marking required by 1.7.5.

It is permitted to use artificial loads to simulate such loads during testing.

1.4.11 Power from a telecommunication network

For the purpose of this standard, the power available from a TELECOMMUNICATION NETWORK is considered to be limited to 15 VA.

1.4.12 Temperature measurement conditions

1.4.12.1 General

Temperatures measured on the EUT shall conform to 1.4.12.2 or 1.4.12.3, as applicable, all temperatures being in degrees Celsius ($^{\circ}\text{C}$); where

- T is the temperature of the given part measured under the prescribed test conditions;
- T_{max} is the maximum temperature specified for compliance with the test;
- T_{amb} is the ambient temperature during test;

T_{ma} is the maximum ambient temperature permitted by the manufacturer's specification, or 25 °C, whichever is greater.

1.4.12.2 Temperature dependent equipment

For equipment where the amount of heating or cooling is designed to be dependent on temperature (for example, the equipment contains a fan that has a higher speed at a higher temperature), the temperature measurement is made at the least favourable ambient temperature within the manufacturer's specified operating range. In this case:

T shall not exceed T_{max} .

NOTE 1 In order to find the highest value of T for each component, it may be necessary to conduct several tests at different values of T_{amb} .

NOTE 2 The least favourable value of T_{amb} may be different for different components.

1.4.12.3 Non-temperature dependent equipment

For equipment where the amount of heating or cooling is not designed to be dependent on ambient temperature, it is permitted to use the method in 1.4.12.2. Alternatively, the test is performed at any value of T_{amb} within the manufacturer's specified operating range. In this case:

T shall not exceed $(T_{max} + T_{amb} - T_{ma})$.

During the test, T_{amb} should not exceed T_{ma} unless agreed by all parties involved.

1.4.13 Temperature measurement methods

Unless a particular method is specified, the temperatures of windings shall be determined either by the thermocouple method or by the resistance method (see Annex E). The temperatures of parts other than windings shall be determined by the thermocouple method. Any other suitable method of temperature measurement which does not noticeably influence the thermal balance and which achieves an accuracy sufficient to show compliance is also permitted. The choice of and position of temperature sensors shall be made so that they have minimum effect on the temperature of the part under test.

1.4.14 Simulated faults and abnormal conditions

Where it is required to apply simulated faults or abnormal operating conditions, these shall be applied in turn and one at a time. Faults that are the direct consequence of a simulated fault or abnormal operating condition are considered to be part of that simulated fault or abnormal operating condition.

When applying simulated faults or abnormal operating conditions, parts, supplies, consumable materials, media and recording materials shall be in place if they are likely to have an effect on the outcome of the test.

Where there is a specific reference to a single fault, the single fault consists of a single failure of any insulation (excluding DOUBLE INSULATION or REINFORCED INSULATION) or a single failure of any component (excluding components with DOUBLE INSULATION or REINFORCED INSULATION). The failure of FUNCTIONAL INSULATION is simulated only when required by 5.3.4 c).

The equipment, circuit diagrams and component specifications are examined to determine those fault conditions that might reasonably be expected to occur. Examples include:

- short-circuits and open circuits of semiconductor devices and capacitors;
- faults causing continuous dissipation in resistors designed for intermittent dissipation;
- internal faults in integrated circuits causing excessive dissipation;
- failure of BASIC INSULATION between current-carrying parts of the PRIMARY CIRCUIT and
 - accessible conductive parts;
 - earthed conductive screens (see Clause C.2);
 - parts of SELV CIRCUITS;
 - parts of LIMITED CURRENT CIRCUITS.

1.4.15 Compliance by inspection of relevant data

Where in this standard compliance of materials, components or subassemblies is checked by inspection or by testing of properties, it is permitted to confirm compliance by reviewing any relevant data or previous test results that are available instead of carrying out the specified TYPE TESTS.

1.5 Components

1.5.1 General

Where safety is involved, components shall comply either with the requirements of this standard or with the safety aspects of the relevant IEC component standards.

NOTE 1 An IEC component standard is considered relevant only if the component in question clearly falls within its Scope.

Ⓢ Notes deleted Ⓢ

Ⓢ NOTE Z1 The use of certain substances in electrical and electronic equipment is restricted within the EU: see Directive 2002/95/EC. Ⓢ

1.5.2 Evaluation and testing of components

Evaluation and testing of components shall be conducted as follows:

- *a component that has been demonstrated to comply with a standard harmonized with the relevant IEC component standard shall be checked for correct application and use in accordance with its rating. It shall be subjected to the applicable tests of this standard as part of the equipment with the exception of those tests which are part of the relevant IEC component standard;*
- *a component that has not been demonstrated to comply with a relevant standard as above shall be checked for correct application and use in accordance with its specified rating. It shall be subjected to the applicable tests of this standard, as part of the equipment, and to the applicable tests of the component standard, under the conditions occurring in the equipment;*

NOTE The applicable test for compliance with a component standard is, in general, conducted separately.

where no relevant IEC component standard exists, or where components are used in circuits not in accordance with their specified ratings, the components shall be tested under the conditions occurring in the equipment. The number of samples required for test is, in general, the same as required by an equivalent standard.

1.5.3 Thermal controls

Thermal controls shall be tested in accordance with Annex K.

1.5.4 Transformers

Transformers shall comply with the relevant requirements of this standard, including those of Annex C.

1.5.5 Interconnecting cables

INTERCONNECTING CABLES provided as part of the equipment shall comply with the relevant requirements of this standard and shall not present a hazard in the meaning of this standard whether they are detachable or non-detachable.

For INTERCONNECTING CABLES supplied alone (for example, printer cables), it is permitted to apply the requirements of this subclause at the option of the manufacturer.

It is permitted to treat cables, or those parts of cables that are within an equipment ENCLOSURE, either as INTERCONNECTING CABLES or as internal wiring.

1.5.6 Capacitors bridging insulation

A capacitor connected between two line conductors in a PRIMARY CIRCUIT, or between one line conductor and the neutral conductor or between the PRIMARY CIRCUIT and protective earth shall comply with one of the subclasses of IEC 60384-14 and shall be used in accordance with its rating. This requirement also applies to a capacitor bridging DOUBLE INSULATION or REINFORCED INSULATION elsewhere in the equipment. The details of the damp heat, steady state test as specified in 4.12 of IEC 60384-14 shall be as follows:

- Temperature: $40\text{ °C} \pm 2\text{ °C}$;
- Humidity: $93\% \pm 3\%$ relative humidity;
- Test duration: 21 days.

NOTE 1 Capacitors that have been subjected to a test duration longer than 21 days are considered to have met the test duration criteria.

The above requirement does not apply to a capacitor connected between a HAZARDOUS VOLTAGE SECONDARY CIRCUIT and protective earth, where only BASIC INSULATION is required.

NOTE 2 The test of 5.2.2 still applies between the HAZARDOUS VOLTAGE SECONDARY CIRCUIT and protective earth.

The appropriate capacitor subclass shall be selected from those listed in Table 1C, according to the rules of application in the table.

Table 1C – Capacitor ratings according to IEC 60384-14

| Capacitor subclass according to IEC 60384-14 | RATED VOLTAGE of the capacitor V r.m.s. | TYPE TEST voltage of the capacitor kV peak |
|--|--|---|
| Y1 | Up to and including 500 | 8 |
| Y2 | Over 150 up to and including 300 | 5 |
| Y4 | Up to and including 150 | 2,5 |
| X1 | - | 4 ^a |
| X2 | - | 2,5 ^a |

Rules for the application of Table 1C

- Capacitors used to bridge BASIC INSULATION, SUPPLEMENTARY INSULATION or REINFORCED INSULATION shall be class Y except that it is permitted to bridge BASIC INSULATION in a SECONDARY CIRCUIT by a class X capacitor.
- The voltage rating of the capacitor shall be at least equal to the RMS WORKING VOLTAGE across the insulation being bridged, determined according to 2.10.2.2.
- For a single capacitor bridging FUNCTIONAL INSULATION, BASIC INSULATION or SUPPLEMENTARY INSULATION, the peak test voltage of the capacitor shall be at least equal to the REQUIRED WITHSTAND VOLTAGE.
- For a single capacitor bridging DOUBLE INSULATION or REINFORCED INSULATION, the peak test voltage of the capacitor shall be at least equal to twice the REQUIRED WITHSTAND VOLTAGE.
- It is permitted to use a higher grade capacitor than the one specified, as follows:
 - subclass Y1 if subclass Y2 is specified;
 - subclass Y1 or Y2 if subclass Y4 is specified;
 - subclass Y1 or Y2 if subclass X1 is specified;
 - subclass X1, Y1 or Y2 if subclass X2 is specified.
- It is permitted to use two or more capacitors in series in place of the single capacitor specified, as follows:
 - subclass Y1 or Y2 if subclass Y1 is specified;
 - subclass Y2 or Y4 if subclass Y2 is specified;
 - subclass X1 or X2 if subclass X1 is specified.
- If two or more capacitors are used in series, they shall
 - all have the same nominal capacitance value;
 - each be rated for the total RMS WORKING VOLTAGE across the insulation; and
 - comply with the other rules above.

^a For capacitance values of more than 1 μF, this test voltage is reduced by a factor equal to \sqrt{C} , where C is the capacitance value in μF.

Table 1D gives a number of informative examples of the application of capacitors selected in accordance with Table 1C. Other examples are possible.

Table 1D – Informative examples of application of capacitors

| AC MAINS SUPPLY VOLTAGE up to and including V r.m.s. | Overvoltage Category | MAINS TRANSIENT VOLTAGE kV | Bridged insulation | Capacitor type | Number of capacitors |
|--|----------------------|-------------------------------|--------------------|----------------|----------------------|
| 150 | II | 1,5 | B or S | Y4 | 1 |
| | II | 1,5 | D or R | Y2 | 1 |
| | II | 1,5 | D or R | Y4 | 2 |
| | III | 2,5 | F | X2 | 1 |
| | III | 2,5 | B or S | Y4 | 1 |
| | III | 2,5 | D or R | Y1 | 1 |
| | IV | 4,0 | F | X1 | 1 |
| | IV | 4,0 | B or S | Y2 | 1 |
| | IV | 4,0 | D or R | Y1 | 1 |
| 250 | II | 2,5 | F | X2 | 1 |
| 300 | II | 2,5 | B or S | Y2 | 1 |
| | II | 2,5 | D or R | Y1 | 1 |
| | II | 2,5 | D or R | Y2 | 2 |
| 250 | III | 4,0 | F | X1 | 1 |
| 300 | III | 4,0 | D or R | Y1 | 1 |
| | III | 4,0 | D or R | Y2 | 2 |
| | IV | 6,0 | B or S | Y1 | 1 |
| | IV | 6,0 | D or R | Y1 | 2 |
| 500 | II | 4,0 | B or S | Y1 | 1 |
| | II | 4,0 | D or R | Y1 | 1 |
| | III | 6,0 | B or S | Y1 | 1 |
| | III | 6,0 | D or R | Y1 | 2 |
| | IV | 8,0 | B or S | Y1 | 1 |
| | IV | 8,0 | D or R | Y1 | 2 |
| The values in the table apply to FUNCTIONAL INSULATION (F), BASIC INSULATION (B), SUPPLEMENTARY INSULATION (S), DOUBLE INSULATION (D) and REINFORCED INSULATION (R). | | | | | |

If an accessible conductive part or circuit is separated from another part by DOUBLE INSULATION or REINFORCED INSULATION that is bridged by a capacitor or capacitors, the accessible part or circuit shall comply with the requirements for a LIMITED CURRENT CIRCUIT in 2.4. This requirement applies after electric strength testing of the insulation with the bridging capacitor or capacitors in place.

NOTE 3 A circuit is a LIMITED CURRENT CIRCUIT if the current through the bridging components complies with 2.4 and other requirements of 2.4 are met.

Compliance is checked by inspection and measurement.

1.5.7 Resistors bridging insulation

1.5.7.1 Resistors bridging functional insulation, basic insulation or supplementary insulation

There are no special requirements for resistors bridging FUNCTIONAL INSULATION, BASIC INSULATION or SUPPLEMENTARY INSULATION, but the relevant requirements of 2.10.3 (or Annex G) and 2.10.4 apply, and in some cases those of 2.4.

Ⓒ Note deleted Ⓒ

1.5.7.2 Resistors bridging double insulation or reinforced insulation between the a.c. mains supply and other circuits

It is permitted to bridge DOUBLE INSULATION or REINFORCED INSULATION by one resistor or by a group of two or more resistors in series under the following conditions. For conditions applicable to circuits connected to an antenna or coaxial cable, see 1.5.7.3.

The resistor or group of resistors shall comply with the minimum CLEARANCES of 2.10.3 or Annex G and the minimum CREEPAGE DISTANCES of 2.10.4 for REINFORCED INSULATION for the total WORKING VOLTAGE across the resistor or group of resistors. For a group of resistors, see also Figure F.13.

If a single resistor is used, it shall pass the resistor test below.

If a group of resistors is used, the CLEARANCE and CREEPAGE DISTANCES are assessed as if each resistor were short-circuited in turn, unless the group passes the resistor test below.

If an accessible conductive part or circuit is separated from another part by DOUBLE INSULATION or REINFORCED INSULATION that is bridged by a resistor or group of resistors, the accessible part or circuit shall comply with the requirements for a LIMITED CURRENT CIRCUIT in 2.4. If a group of resistors is used, the current measurement in 2.4.2 is made with each resistor short-circuited in turn, unless the group passes the resistor test below. This current is measured after electric strength testing of the insulation with the bridging resistor or group of resistors in place.

Compliance is checked by inspection and measurement and, if specified above, by the following resistor test on ten samples. A sample is a single resistor if used alone, or a group of resistors in series.

Resistor Test

Before the test, the resistance of each sample is measured.

The samples are subjected to the damp heat test according to IEC 60068-2-78, with the following details:

- Temperature: 40 °C ± 2 °C;*
- Humidity: 93 % ± 3 % relative humidity;*
- Test duration: 21 days.*

NOTE Resistors that have been subjected to a test duration longer than 21 days are considered to have met the test duration criteria.

Each sample is then subjected to ten impulses of alternating polarity, using the impulse test generator reference 2 of Table N.1. The interval between successive impulses is 60 s, and U_c is equal to the applicable REQUIRED WITHSTAND VOLTAGE.

After the test, the resistance of each sample shall not have changed by more than 10 %.

No failure is permitted.

1.5.7.3 Resistors bridging double insulation or reinforced insulation between the a.c. mains supply and circuits connected to an antenna or coaxial cable

The requirements and tests of 1.5.7.2 apply except the impulse test generator is as specified in reference 3 of Table N.1 if the circuit is connected to an antenna or reference 1 of Table N.1 if the circuit is connected to a coaxial cable.

After the test, the resistance of each sample shall not have changed by more than 20 % and no failure is permitted.

NOTE If a resistor or a group of resistors is connected between the PRIMARY CIRCUIT and a CABLE DISTRIBUTION SYSTEM, 7.4 also applies.

1.5.8 Components in equipment for IT power distribution systems

For equipment to be connected to IT power distribution systems, components connected between line and earth shall be capable of withstanding the stress due to the line-to-line voltage. However, capacitors rated for the applicable line-to-neutral voltage are permitted in such applications if they comply with subclass Y1, Y2 or Y4 of IEC 60384-14.

NOTE 1 The above capacitors are endurance tested at 170 % of the voltage rating of the capacitor.

Ⓢ Note deleted Ⓢ

Compliance is checked by inspection.

1.5.9 Surge suppressors

1.5.9.1 General

It is permitted to use any type of surge suppressor, including a voltage dependent resistor (VDR), in a SECONDARY CIRCUIT.

If a surge suppressor is used in a PRIMARY CIRCUIT, it shall be a VDR and it shall comply with Annex Q.

NOTE 1 A VDR is sometimes referred to as a varistor or a metal oxide varistor (MOV). Devices such as gas discharge tubes, carbon blocks and semiconductor devices with non-linear voltage/current characteristics are not considered as VDRs in this standard.

NOTE 2 It is not a requirement of this standard to comply with any particular component standard for surge suppressors used in SECONDARY CIRCUITS. However, attention is drawn to the IEC 61643 series of standards, in particular:

- IEC 61643-21 (surge suppressors in telecommunications application)
- IEC 61643-311 (gas discharge tubes)
- IEC 61643-321 (avalanche breakdown diodes)
- IEC 61643-331 (metal oxide varistors).

Compliance is checked by inspection and application of Annex Q as appropriate.

1.5.9.2 Protection of VDRs

For protection against

- temporary overvoltages above the maximum continuous voltage,
- thermal overload due to leakage current within the VDR, and
- burning and bursting of the VDR in the event of a short-circuit fault,

an interrupting means having an adequate breaking capacity shall be connected in series with the VDR. This requirement does not apply to a VDR in a LIMITED CURRENT CIRCUIT.

NOTE 1 For temporary overvoltages from the AC MAINS SUPPLY, see IEC 60664-1.

NOTE 2 During the lifetime of a VDR the leakage current increases with the number of switching cycles in the VDR. This leakage current causes a permanent and continuously increasing temperature stress, which can cause the VDR to burn or burst.

Compliance is checked by inspection.

1.5.9.3 Bridging of functional insulation by a VDR

It is permitted to bridge FUNCTIONAL INSULATION by a VDR.

Compliance is checked by inspection.

1.5.9.4 Bridging of basic insulation by a VDR

It is permitted to bridge BASIC INSULATION by a VDR provided that one side of the VDR is earthed in accordance with 2.6.1 a).

Equipment with such a VDR bridging BASIC INSULATION shall be one of the following:

- PLUGGABLE EQUIPMENT TYPE B; or
- PERMANENTLY CONNECTED EQUIPMENT; or
- equipment that has provision for a permanently connected PROTECTIVE EARTHING CONDUCTOR and is provided with instructions for the installation of that conductor.

Ⓒ Note deleted Ⓒ

Compliance is checked by inspection.

1.5.9.5 Bridging of supplementary, double or reinforced insulation by a VDR

It is not permitted to bridge SUPPLEMENTARY INSULATION, DOUBLE INSULATION or REINFORCED INSULATION by a VDR.

Compliance is checked by inspection.

1.6 Power interface

1.6.1 AC power distribution systems

AC power distribution systems are classified as TN-C, TN-C-S, TN-S, TT or IT (see Annex V).

1.6.2 Input current

The steady state input current of the equipment shall not exceed the RATED CURRENT by more than 10 % under NORMAL LOAD.

NOTE See also 1.4.10.

Compliance is checked by measuring the input current of the equipment at NORMAL LOAD under the following conditions:

- *where an equipment has more than one RATED VOLTAGE, the input current is measured at each RATED VOLTAGE;*
- *where an equipment has one or more RATED VOLTAGE RANGES, the input current is measured at each end of each RATED VOLTAGE RANGE. Where a single value of RATED CURRENT is marked (see 1.7.1), it is compared with the higher value of input current measured in the associated voltage range. Where two values of RATED CURRENT are marked, separated by a hyphen, they are compared with the two values measured in the associated voltage range.*

In each case, the readings are taken when the input current has stabilized. If the current varies during the normal operating cycle, the steady-state current is taken as the mean indication of the value, measured on a recording r.m.s. ammeter, during a representative period.

1.6.3 Voltage limit of hand-held equipment

The RATED VOLTAGE of HAND-HELD EQUIPMENT shall not exceed 250 V.

Compliance is checked by inspection.

1.6.4 Neutral conductor

The neutral conductor, if any, shall be insulated from earth and from the BODY throughout the equipment as if it were a line conductor. Components connected between neutral and earth shall be rated for the line-to-neutral voltage (however, see also 1.5.8).

Compliance is checked by inspection.

1.7 Markings and instructions

NOTE Additional requirements for markings and instructions are contained in the following subclauses:

| | | | |
|------------|------------------------------|-------------------|--|
| 2.1.1.2 | Battery compartments | 4.2.5 | Impact test |
| 2.1.1.8 | Energy hazards | 4.3.3 | Adjustable controls |
| 2.3.2.3 | Protection by earthing | 4.3.5 | Plugs and sockets |
| 2.6.1 | Unearthed parts | 4.3.13.4 | UV radiation |
| 2.6.2 | FUNCTIONAL EARTHING | 4.3.13.5 | Lasers |
| 2.6.3.4 c) | Bonding conductors | 4.4.2 | Hazardous moving parts |
| 2.6.5.1 | Bonding conductors | 4.5.3 Table 4C | Marking of hot parts |
| 2.7.1 | External protective devices | 4.5.4 | Touch temperatures |
| 2.7.6 | Neutral fusing | 4.6.2 | Equipment on non-combustible floors |
| 2.10.3.2 | Overvoltage Categories | 4.6.3 | Removable doors and covers |
| 3.2.1.2 | DC MAINS SUPPLY | 5.1.7.1 | TOUCH CURRENT exceeding 3,5 mA |
| 3.3.7 | Grouping of wiring terminals | 5.1.8.2 | Summation of TOUCH CURRENTS |
| 3.4.3 | Disconnect devices | 6.1.1 and 6.1.2.2 | Earthing for a TELECOMMUNICATION NETWORK |
| 3.4.6 | Two-pole disconnect devices | 7.2 and 7.4.1 | Earthing for a CABLE DISTRIBUTION SYSTEM |
| 3.4.7 | Four-pole disconnect devices | G.2.1 | Equipment in Overvoltage Categories III and IV |
| 3.4.9 | Plugs as disconnect devices | | |
| 3.4.10 | Interconnected equipment | | |
| 3.4.11 | Multiple power sources | | |
| 4.1 | Equipment stability | | |

Compliance with each subclause of 1.7 is checked by inspection unless otherwise specified (see 1.7.11).

1.7.1 Power rating

Equipment shall be provided with a power rating marking, the purpose of which is to specify a supply of correct voltage and frequency, and of adequate current-carrying capacity.

If a unit is not provided with a means for direct connection to a MAINS SUPPLY, it need not be marked with any electrical rating, such as its RATED VOLTAGE, RATED CURRENT or RATED FREQUENCY.

For equipment intended to be installed by an OPERATOR, the marking shall be readily visible in an OPERATOR ACCESS AREA, including any area that is directly visible only after an OPERATOR has opened a door or cover. If a manual voltage selector is not OPERATOR-accessible, the marking shall indicate the RATED VOLTAGE for which the equipment is set during manufacture; a temporary marker is permitted for this purpose. Marking is permitted on any outer surface of the equipment, except the bottom of equipment having a mass exceeding 18 kg. Additionally, on STATIONARY EQUIPMENT, the marking shall be visible after the equipment has been installed as in normal use.

For equipment intended to be installed by a SERVICE PERSON, and if the marking is in a SERVICE ACCESS AREA, the location of the permanent marking shall be indicated in the installation instructions or on a readily visible marker on the equipment. It is permitted to use a temporary marker for this purpose.

The marking shall include the following:

- RATED VOLTAGE(S) or RATED VOLTAGE RANGE(S), in volts;
 - the voltage range shall have a hyphen (-) between the minimum and maximum RATED VOLTAGES and when multiple RATED VOLTAGES or RATED VOLTAGE RANGES are given, they shall be separated by a solidus (/);

NOTE 1 Some examples of RATED VOLTAGE markings are:

- RATED VOLTAGE RANGE: 220-240 V. This means that the equipment is designed to be connected to an AC MAINS SUPPLY having any voltage between 220 V and 240 V.
- Multiple RATED VOLTAGE: 120/230/240 V. This means that the equipment is designed to be connected to an AC MAINS SUPPLY having a voltage of 120 V or 230 V or 240 V, usually after internal adjustment.

- if equipment is to be connected to both of the line conductors and to the neutral conductor of a single-phase, three-wire power distribution system, the marking shall give the line-to-neutral voltage and the line-to-line voltage, separated by a solidus (/), with the added notation "Three wires plus protective earth", "3W + PE" or equivalent.

NOTE 2 Some examples of the above system rating markings are:

120/240 V; 3 wire + PE

120/240 V; 3W +  (60417-IEC-5019)

100/200 V; 2W + N + PE

- symbol for nature of supply, for d.c. only;
- RATED FREQUENCY or RATED FREQUENCY RANGE, in hertz, unless the equipment is designed for d.c. only;
- RATED CURRENT, in milliamperes or amperes;
 - for equipment with multiple RATED VOLTAGES, the corresponding RATED CURRENTS shall be marked such that the different current ratings are separated by a solidus (/) and the relation between RATED VOLTAGE and associated RATED CURRENT appears distinctly;
 - equipment with a RATED VOLTAGE RANGE shall be marked with either the maximum RATED CURRENT or with the current range;
 - the marking for RATED CURRENT of a group of units having a single supply connection shall be placed on the unit which is directly connected to a MAINS SUPPLY. The RATED CURRENT marked on that unit shall be the total maximum current that can be on circuit at the same time and shall include the combined currents to all units in the group that can be supplied simultaneously through the unit and that can be operated simultaneously.

NOTE 3 Some examples of RATED CURRENT markings are:

- for equipment with multiple RATED VOLTAGES:

120/240 V; 2,4/1,2 A

- for equipment with a RATED VOLTAGE RANGE:

100-240 V; 2,8 A

100-240 V; 2,8-1,4 A

100-120 V; 2,8 A

200-240 V; 1,4 A

It is recognized that in some regions it is customary to use a point (.) as a decimal marker instead of a comma.

- manufacturer's name or trade-mark or identification mark;
- manufacturer's model identification or type reference;
- symbol  (IEC 60417-5172 (DB:2003-02)), for CLASS II EQUIPMENT only, except where this is forbidden by 2.6.2.

Additional markings are permitted, provided that they do not give rise to misunderstanding.

Where symbols are used, they shall conform to ISO 7000 or IEC 60417 where appropriate symbols exist.

1.7.2 Safety instructions and marking

1.7.2.1 General

Sufficient information shall be provided to the USER concerning any condition necessary to ensure that, when used as prescribed by the manufacturer, the equipment is unlikely to present a hazard within the meaning of this standard.

If it is necessary to take special precautions to avoid the introduction of hazards when operating, installing, servicing, transporting or storing equipment, the necessary instructions shall be made available.

NOTE 1 Special precautions may be necessary, for example, for connection of the equipment to the supply and for the interconnection of separate units, if any.

NOTE 2 Where appropriate, installation instructions should include reference to national wiring rules.

NOTE 3 In many countries, instructions and equipment marking related to safety are required to be in a language that is acceptable in the country in which the equipment is to be installed. Servicing instructions are normally made available only to SERVICE PERSONS and are generally acceptable in the English language only.

Ⓒ Notes deleted Ⓒ

Ⓒ NOTE Z1 In addition, the instructions shall include, as far as applicable, a warning that excessive sound pressure from earphones and headphones can cause hearing loss. Ⓒ

The operating instructions, and the installation instructions for PLUGGABLE EQUIPMENT intended for USER installation, shall be made available to the USER.

1.7.2.2 Disconnect devices

Where the disconnect device is not incorporated in the equipment (see 3.4.3) or where the plug on the power supply cord is intended to serve as the disconnect device, the installation instructions shall state that:

- for PERMANENTLY CONNECTED EQUIPMENT, a readily accessible disconnect device shall be incorporated external to the equipment;
- for PLUGGABLE EQUIPMENT, the socket-outlet shall be installed near the equipment and shall be easily accessible.

1.7.2.3 Overcurrent protective devices

For PLUGGABLE EQUIPMENT TYPE B OR PERMANENTLY CONNECTED EQUIPMENT, the installation instructions shall specify the maximum rating of an overcurrent protective device to be provided external to the equipment, unless there are appropriate overcurrent protective devices in the equipment [see also 2.6.3.3 b)].

NOTE The specified maximum rating may not be one of the protective device ratings available in the country of installation. Allowance should be made for the use of a device with a smaller rating that will still be adequate for the equipment RATED CURRENT plus any necessary allowance for inrush current.

1.7.2.4 IT power distribution systems

If the equipment has been designed or, when required, modified for connection to an IT power distribution system, the equipment installation instructions shall so state.

1.7.2.5 Operator access with a tool

If a TOOL is necessary to gain access to an OPERATOR ACCESS AREA, either all other compartments within that area containing a hazard shall be inaccessible to the OPERATOR by the use of the same TOOL, or such compartments shall be marked to discourage OPERATOR access.

An acceptable marking for an electric shock hazard is  (ISO 3864, No. 5036).

1.7.2.6 Ozone

For equipment that may produce ozone, the installation and operating instructions shall refer to the need to take precautions to ensure that the concentration of ozone is limited to a safe value.

NOTE The present recommended long term exposure limit for ozone is $0,1 \times 10^{-6}$ ($0,2 \text{ mg/m}^3$) calculated as an 8 h time-weighted average concentration. It should be noted that ozone is heavier than air.

1.7.3 Short duty cycles

Equipment not intended for continuous operation shall be marked with its RATED OPERATING TIME, and RATED RESTING TIME unless the operating time is limited by the construction.

The marking of RATED OPERATING TIME shall correspond to normal use.

The marking of the RATED OPERATING TIME shall precede the marking of the RATED RESTING TIME (if given), the two markings being separated by a solidus (/).

1.7.4 Supply voltage adjustment

For equipment intended for connection to multiple RATED VOLTAGES or FREQUENCIES, the method of adjustment shall be fully described in the servicing or installation instructions.

Unless the means of adjustment is a simple control near the power rating marking, and the setting of this control is obvious by inspection, the following instruction or a similar one shall appear in or near the power rating marking:

**SEE INSTALLATION INSTRUCTIONS
BEFORE CONNECTING TO THE SUPPLY**

1.7.5 Power outlets on the equipment

If any standard power supply outlet in the equipment is accessible to the OPERATOR, a marking shall be placed in the vicinity of the outlet to show the maximum load that is permitted to be connected to it.

Socket-outlets conforming to IEC 60083 are examples of standard power supply outlets.

1.7.6 Fuse identification

Marking shall be located adjacent to each fuse or fuseholder, or on the fuseholder, or in another location provided that it is obvious to which fuse the marking applies, giving the fuse current rating and, where fuses of different voltage rating value could be fitted, the fuse voltage rating.

Where fuses with special fusing characteristics such as time delay or breaking capacity are necessary, the type shall also be indicated.

For fuses not located in OPERATOR ACCESS AREAS and for soldered-in fuses located in OPERATOR ACCESS AREAS, it is permitted to provide an unambiguous cross-reference (for example, F1, F2, etc.) to the servicing instructions that shall contain the relevant information.

NOTE See 2.7.6 regarding other warnings to SERVICE PERSONS.

1.7.7 Wiring terminals

1.7.7.1 Protective earthing and bonding terminals

A wiring terminal intended for connection of a PROTECTIVE EARTHING CONDUCTOR shall be indicated by the symbol \oplus (IEC 60417-5019 (DB:2002-10)). This symbol shall not be used for other earthing terminals.

It is not a requirement to mark terminals for PROTECTIVE BONDING CONDUCTORS, but where such terminals are marked, the symbol \perp (IEC 60417-5017 (DB:2002-10)) shall be used.

The following situations are exempt from the above requirements:

- where terminals for the connection of a supply are provided on a component (for example, a terminal block) or subassembly (for example, a power supply unit), the symbol \perp is permitted for the protective earthing terminal instead of \oplus ;
- on subassemblies or components, the symbol \oplus is permitted in place of the symbol \perp provided that it does not give rise to confusion.

These symbols shall not be located on screws, or other parts that might be removed when conductors are being connected.

These requirements are applicable to terminals for connection of a PROTECTIVE EARTHING CONDUCTOR whether run as an integral part of a power supply cord or with supply conductors.

1.7.7.2 Terminals for a.c. mains supply conductors

For PERMANENTLY CONNECTED EQUIPMENT and equipment with ordinary NON-DETACHABLE POWER SUPPLY CORDS:

- terminals intended exclusively for connection of the AC MAINS SUPPLY neutral conductor, if any, shall be indicated by the capital letter N; and
- on three-phase equipment, if incorrect phase rotation could cause overheating or other hazard, terminals intended for connection of the AC MAINS SUPPLY line conductors shall be marked in such a way that, in conjunction with any installation instructions, the sequence of phase rotation is unambiguous.

These indications shall not be located on screws, or other parts that might be removed when conductors are being connected.

1.7.7.3 Terminals for d.c. mains supply conductors

For PERMANENTLY CONNECTED EQUIPMENT and equipment with ordinary NON-DETACHABLE POWER SUPPLY CORDS, terminals intended exclusively for connection of a DC MAINS SUPPLY shall be marked to indicate polarity.

If a single terminal is provided, both as a main protective earthing terminal in the equipment and for the connection to one pole of the DC MAINS SUPPLY, it shall be marked as specified in 1.7.7.1, in addition to polarity marking.

These indications shall not be located on screws or other parts that might be removed when conductors are being connected.

1.7.8 Controls and indicators

1.7.8.1 Identification, location and marking

Unless it is obviously unnecessary, indicators, switches and other controls affecting safety shall be identified or located so as to indicate clearly which function they control.

Markings and indications for switches and other controls shall be located either:

- on or adjacent to the switch or control, or
- elsewhere, provided that it is obvious to which switch or control the marking applies.

Indications used for this purpose shall, wherever practicable, be comprehensible without a knowledge of languages, national standards, etc.

1.7.8.2 Colours

Where safety is involved, colours of controls and indicators shall comply with IEC 60073. Where colours are used for functional controls or indicators, any colour, including red, is permitted provided that it is clear that safety is not involved.

1.7.8.3 Symbols

Where symbols are used on or near controls (for example, switches and push buttons) to indicate "ON" and "OFF" conditions, they shall be the line | for "ON" and circle ○ for "OFF" (IEC 60417-5007 (DB:2002-10)) and IEC 60417-5008 (DB:2002-10). For push-push type switches the symbol ⊕ shall be used (IEC 60417-5010 (DB:2002-10)).

It is permitted to use the symbols ○ and | to indicate the "OFF" and "ON" positions of any primary or secondary power switches, including isolating switches.

A "STAND-BY" condition shall be indicated by the symbol ⏻ (IEC 60417-5009 (DB:2002-10)).

1.7.8.4 Markings using figures

If figures are used for indicating different positions of any control, the "OFF" position shall be indicated by the figure 0 (zero) and higher figures shall be used to indicate greater output, input, etc.

1.7.9 Isolation of multiple power sources

Where there is more than one connection supplying HAZARDOUS VOLTAGES or HAZARDOUS ENERGY LEVELS to equipment, a prominent marking, located close to the entry point provided for a SERVICE PERSON to gain access to the hazardous parts, shall be provided to indicate which disconnect device or devices isolate the equipment completely and which disconnect devices can be used to isolate each section of the equipment.

1.7.10 Thermostats and other regulating devices

THERMOSTATS and similar regulating devices intended to be adjusted during installation or in normal use shall be provided with an indication for the direction of adjustment to increase or decrease the value of the characteristic being adjusted. Indication by the symbols + and – is permitted.

1.7.11 Durability

Any marking required by this standard shall be durable and legible. In considering the durability of the marking, the effect of normal use shall be taken into account.

Compliance is checked by inspection and by rubbing the marking by hand for 15 s with a piece of cloth soaked with water and again for 15 s with a piece of cloth soaked with petroleum spirit. After this test, the marking shall be legible; it shall not be possible to remove marking plates easily and they shall show no curling.

The petroleum spirit to be used for the test is aliphatic solvent hexane having a maximum aromatics content of 0,1 % by volume, a kauributenol value of 29, an initial boiling point of approximately 65 °C, a dry point of approximately 69 °C and a mass per unit volume of approximately 0,7 kg/l.

As an alternative, it is permitted to use a reagent grade hexane with a minimum of 85 % as n-hexane.

NOTE The designation "n-hexane" is chemical nomenclature for a "normal" or straight chain hydrocarbon. This petroleum spirit may further be identified as a certified ACS (American Chemical Society) reagent grade hexane (CAS# 110-54-3).

1.7.12 Removable parts

Marking required by this standard shall not be placed on removable parts that can be replaced in such a way that the marking would become misleading.

1.7.13 Replaceable batteries

If an equipment is provided with a replaceable battery, and if replacement by an incorrect type could result in an explosion (for example, with some lithium batteries), the following applies:

- if the battery is placed in an OPERATOR ACCESS AREA, there shall be a marking close to the battery or a statement in both the operating and the servicing instructions;
- if the battery is placed elsewhere in the equipment, there shall be a marking close to the battery or a statement in the servicing instructions.

This marking or statement shall include the following or similar text:

CAUTION
RISK OF EXPLOSION IF BATTERY IS REPLACED
BY AN INCORRECT TYPE.
DISPOSE OF USED BATTERIES ACCORDING
TO THE INSTRUCTIONS

1.7.14 Equipment for restricted access locations

For equipment intended only for installation in a RESTRICTED ACCESS LOCATION, the installation instructions shall contain a statement to this effect.

2 Protection from hazards

2.1 Protection from electric shock and energy hazards

2.1.1 Protection in operator access areas

This subclause specifies requirements for protection against electric shock from energized parts based on the principle that the OPERATOR is permitted to have access to:

- bare parts of SELV CIRCUITS; and
- bare parts of LIMITED CURRENT CIRCUITS; and
- TNV CIRCUITS under the conditions specified in 2.1.1.1.

Access to other energized parts, and to their insulation, is restricted as specified in 2.1.1.1.

Additional requirements are specified in 2.1.1.5 and 2.1.1.8 for protection against energy hazards.

2.1.1.1 Access to energized parts

The equipment shall be so constructed that in OPERATOR ACCESS AREAS there is adequate protection against contact with:

- bare parts of ELV CIRCUITS; and
- bare parts at HAZARDOUS VOLTAGES; and
- SOLID INSULATION providing FUNCTIONAL INSULATION or BASIC INSULATION of parts or wiring in ELV CIRCUITS, except as permitted in 2.1.1.3; and
- SOLID INSULATION providing functional insulation or basic insulation of parts or wiring at hazardous voltages; and

NOTE 1 FUNCTIONAL INSULATION includes, but is not limited to, insulation, such as lacquer, solvent-based enamel, ordinary paper, cotton and oxide film, or displaceable insulation such as beads and sealing compounds other than self-hardening resin.

- unearthed conductive parts separated from ELV CIRCUITS or from parts at HAZARDOUS VOLTAGES by FUNCTIONAL INSULATION or BASIC INSULATION only; and
- bare parts of TNV CIRCUITS, except that access is permitted to:
 - contacts of connectors that cannot be touched by the test probe (Figure 2C);
 - bare conductive parts in the interior of a battery compartment that complies with 2.1.1.2;
 - bare conductive parts of TNV-1 CIRCUITS that have any point connected in accordance with 2.6.1 d) to a protective earthing terminal;
 - bare conductive parts of connectors in TNV-1 CIRCUITS that are separated from unearthed accessible conductive parts of the equipment in accordance with 6.2.1.

NOTE 2 A typical application is the shell for a coaxial connector.

NOTE 3 Access to TNV-1 CIRCUITS and TNV-3 CIRCUITS via other circuits is also restricted by 6.2.1 in some cases.

Unrestricted access is permitted to LIMITED CURRENT CIRCUITS.

These requirements apply for all positions of the equipment when it is wired and operated as in normal use.

Protection shall be achieved by insulation or by guarding or by the use of interlocks.

Compliance is checked by all of the following.

a) *Inspection.*

b) *A test with the test finger, Figure 2A, which shall not contact parts described above when applied to openings in the ENCLOSURES after removal of parts that can be detached by an OPERATOR, including fuseholders, and with OPERATOR access doors and covers open. It is permitted to leave lamps in place for this test. Connectors that can be separated by an OPERATOR, other than those complying with IEC 60083, IEC 60309, IEC 60320, IEC 60906-1 or IEC 60906-2, shall also be tested during disconnection.*

c) *A test with the test pin, Figure 2B, which shall not contact bare parts at HAZARDOUS VOLTAGES when applied to openings in an external ELECTRICAL ENCLOSURE. Parts that can be detached by an OPERATOR, including fuseholders and lamps, are left in place, and OPERATOR access doors and covers are closed during this test.*

d) *A test with the test probe, Figure 2C, where appropriate.*

The test finger, the test pin and the test probe are applied as above, without appreciable force, in every possible position, except that floor-standing equipment having a mass exceeding 40 kg is not tilted.

Equipment intended for building-in or rack-mounting, or for incorporation in larger equipment, is tested with access to the equipment limited according to the method of mounting detailed in the installation instructions.

Openings preventing the entry of the test finger, test b) above, are further tested by means of a straight unjointed version of the test finger applied with a force of 30 N. If the unjointed finger enters, test b) is repeated except that the finger is pushed through the opening using any necessary force up to 30 N.

NOTE 4 If an electrical contact indicator is used to show contact, care should be taken to ensure that the application of the test does not damage components of electronic circuits.

Where contact between the test tool and the part is not permitted in the above tests, there is no requirement for a minimum air gap for voltages not exceeding 1 000 V a.c. or 1 500 V d.c. For higher voltages, there shall be an air gap between the part at HAZARDOUS VOLTAGE and the test finger, Figure 2A, or the test pin, Figure 2B, placed in its most unfavourable position. This air gap, see Figure 2D, shall either

- have a minimum length equal to the minimum CLEARANCE for BASIC INSULATION specified in 2.10.3 (or Annex G), or*
- shall withstand the relevant electric strength test in 5.2.2.*

If components are movable, for instance, for the purpose of belt tensioning, the test with the test finger is made with each component in its most unfavourable position within the range of adjustment, the belt being removed, if necessary, for this purpose.

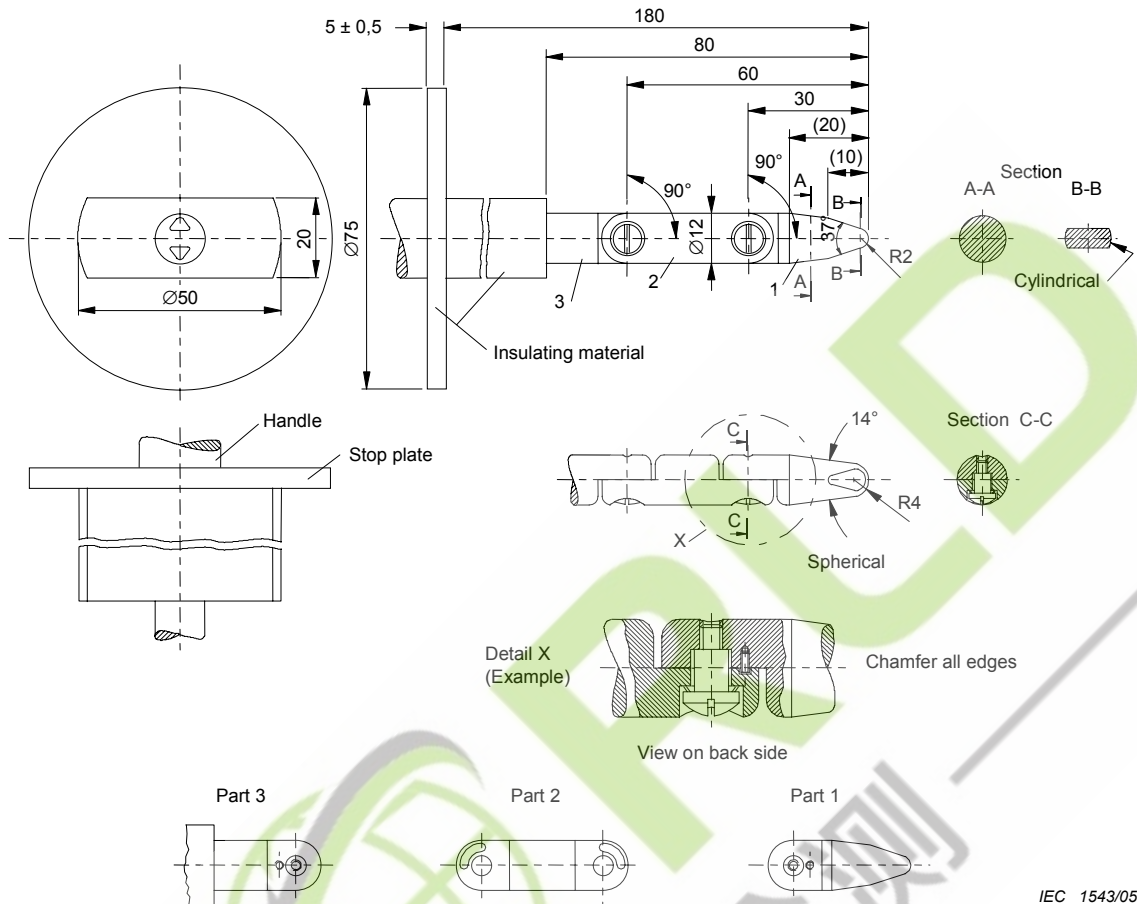

IEC 1543/05

Linear dimensions in millimetres

Tolerances on dimensions without specific tolerances:

- 14° and 37° angles: $\pm 15'$
- on radii: $\pm 0,1 \text{ mm}$
- on linear dimensions:
 - $\leq 15 \text{ mm}$: $\begin{matrix} 0 \\ -0,1 \end{matrix} \text{ mm}$
 - $> 15 \text{ mm} \leq 25 \text{ mm}$: $\pm 0,1 \text{ mm}$
 - $> 25 \text{ mm}$: $\pm 0,3 \text{ mm}$

Material of finger: heat-treated steel, for example.

Both joints of this finger can be bent through an angle of $90^\circ +10^\circ_0$ but in one and the same direction only.

NOTE 1 Using the pin and groove solution is only one of the possible approaches in order to limit the bending angle to 90° . For this reason, dimensions and tolerances of these details are not given in the drawing. The actual design must ensure a 90° bending angle with a 0° to $+10^\circ$ tolerance.

NOTE 2 Dimensions in parentheses are for information only.

NOTE 3 The test finger is taken from Figure 2, test probe B of IEC 61032. In some cases, the tolerances are different.

Figure 2A – Test finger

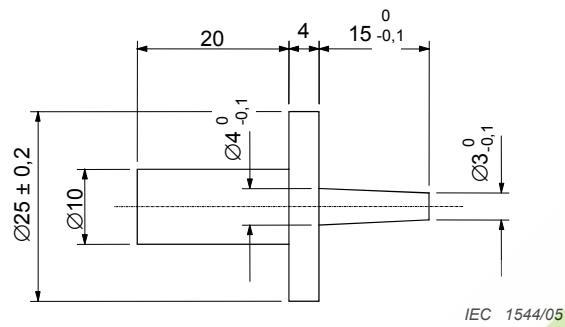

Dimensions in millimetres

The handle dimensions ($\varnothing 10$ and 20) are not critical.

NOTE The test pin dimensions are those given in Figure 9, test probe 13 of IEC 61032. In some cases the tolerances are different.

Figure 2B – Test pin

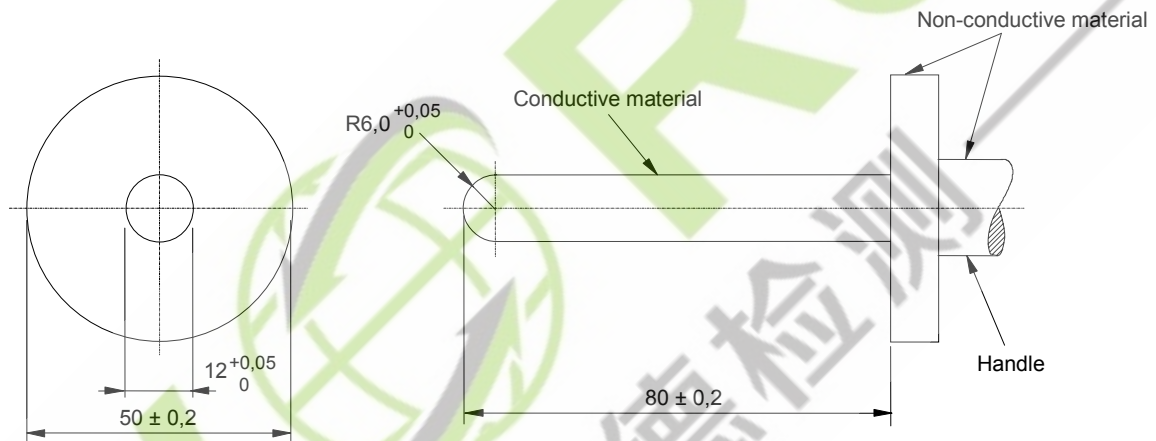

Dimensions in millimetres

Figure 2C – Test probe

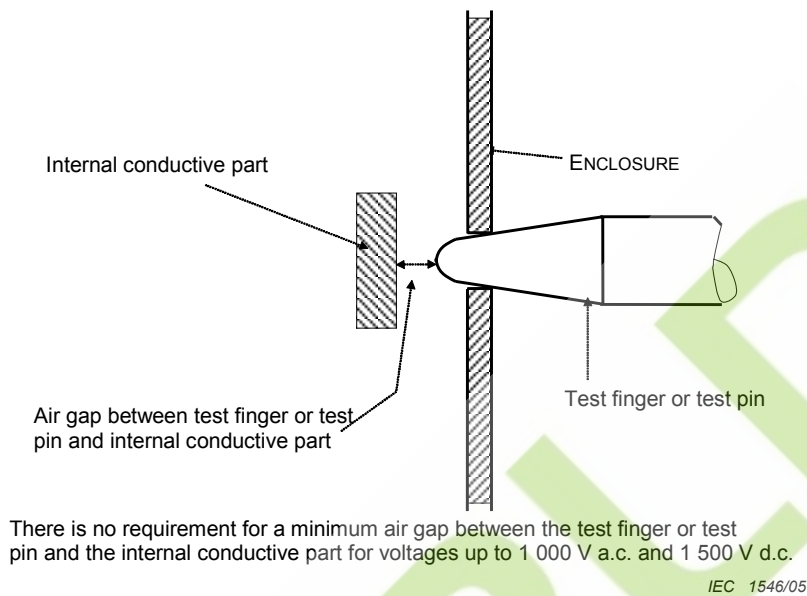

Figure 2D - Accessibility of internal conductive parts

2.1.1.2 Battery compartments

Access by an OPERATOR to bare conductive parts of TNV CIRCUITS within a battery compartment in the equipment is permitted if all of the following conditions are met:

- the compartment has a door that requires a deliberate technique to open, such as the use of a TOOL or latching device; and
- the TNV CIRCUIT is not accessible when the door is closed; and
- there is a marking next to the door, or on the door if the door is secured to the equipment, with instructions for protection of the USER once the door is opened.

Information stating that the telephone cord is to be disconnected prior to opening the door is an example of an acceptable instruction.

Compliance is checked by inspection.

2.1.1.3 Access to ELV wiring

Insulation of internal wiring in an ELV CIRCUIT is permitted to be accessible to an OPERATOR provided that:

- a) the insulation meets the requirements for SUPPLEMENTARY INSULATION detailed in 3.1.4; or
- b) all of the following apply:
 - the wiring does not need to be handled by the OPERATOR and is so placed that the OPERATOR is unlikely to pull on it, or is so fixed that the connecting points are relieved from strain; and
 - the wiring is routed and fixed so as not to touch unearthed accessible conductive parts; and

- the insulation passes the electric strength test of 5.2.2 for SUPPLEMENTARY INSULATION; and
- the distance through the insulation is not less than that given in Table 2A.

Table 2A – Distance through insulation of internal wiring

| WORKING VOLTAGE (in case of failure of BASIC INSULATION) | | Minimum distance through insulation mm |
|---|---------------------------------|--|
| V peak or d.c. | V r.m.s. (sinusoidal) | |
| Over 71 up to and including 350 | Over 50 up to and including 250 | 0,17 |
| Over 350 | Over 250 | 0,31 |

Compliance is checked by inspection and measurement, and by the test of 5.2.2.

2.1.1.4 Access to hazardous voltage circuit wiring

Where the insulation of internal wiring at HAZARDOUS VOLTAGE is accessible to an OPERATOR, or is not routed and fixed to prevent it from touching unearthed accessible conductive parts, it shall meet the requirements of 3.1.4 for DOUBLE INSULATION or REINFORCED INSULATION.

Compliance is checked by inspection and measurement and, if necessary, by test.

2.1.1.5 Energy hazards

There shall be no risk of injury due to an energy hazard in an OPERATOR ACCESS AREA.

Compliance is checked by inspection and measurement and, if necessary, by tests.

- a) *A risk of injury due to an energy hazard exists if it is likely that two or more bare parts (one of which may be earthed) between which a HAZARDOUS ENERGY LEVEL exists, will be bridged by a metallic object.*
- b) *The likelihood of bridging the parts under consideration is determined by means of the test finger, Figure 2A (see 2.1.1.1), in a straight position. It shall not be possible to bridge the parts with this test finger, applied without appreciable force.*
- c) *The existence of a HAZARDOUS ENERGY LEVEL is determined as follows:*
 - 1) *with the equipment operating under normal operating conditions, a variable resistive load is connected to the parts under consideration and adjusted to obtain a level of 240 VA. Further adjustment is made, if necessary, to maintain 240 VA for a period of 60 s. If the voltage is 2 V or more, the output power is at a HAZARDOUS ENERGY LEVEL, unless an overcurrent protective device opens during the above test, or for any other reason the power cannot be maintained at 240 VA for 60 s;*
 - 2) *the stored energy in a capacitor is at a HAZARDOUS ENERGY LEVEL if the voltage, U, is 2 V or more, and the stored energy, E, calculated from the following equation, exceeds 20 J:*

$$E = 0,5 CU^2 \times 10^{-6}$$

where

E is the energy, in joules (J);

C is the capacitance, in microfarads (μF);

U is the measured voltage on the capacitor, in volts (V).

2.1.1.6 Manual controls

Conductive shafts of operating knobs, handles, levers and the like in OPERATOR ACCESS AREAS shall not be connected to parts at HAZARDOUS VOLTAGES, to ELV CIRCUITS or to TNV CIRCUITS.

In addition, conductive operating knobs, handles, levers and the like that are manually moved in normal use and that are earthed only through a pivot or bearing, shall either:

- be separated from parts at HAZARDOUS VOLTAGES by DOUBLE INSULATION or REINFORCED INSULATION; or
- have their accessible parts covered by SUPPLEMENTARY INSULATION for a HAZARDOUS VOLTAGE and by BASIC INSULATION for a TNV CIRCUIT.

Compliance is checked by inspection and measurement, and by the applicable electric strength tests of 5.2.2.

2.1.1.7 Discharge of capacitors in equipment

Equipment shall be so designed that, at an OPERATOR-accessible external point of disconnection of a MAINS SUPPLY, the risk of electric shock from stored charge on capacitors connected in the equipment is reduced. No test for shock hazard is required unless the nominal voltage of the MAINS SUPPLY exceeds 42,4 V peak or 60 V d.c.

Compliance is checked by inspection of the equipment and relevant circuit diagrams, taking into account the possibility of disconnection of the supply with any on/off switch in either position.

Equipment is considered to comply if any capacitor having a marked or nominal capacitance exceeding 0,1 μF and in a circuit connected to the MAINS SUPPLY has a means of discharge resulting in a time constant not exceeding:

- 1 s for PLUGGABLE EQUIPMENT TYPE A; and
- 10 s for PLUGGABLE EQUIPMENT TYPE B.

The relevant time constant is the product of the effective capacitance in microfarads and the effective discharge resistance in megohms. If it is difficult to determine the effective capacitance and resistance values, a measurement of voltage decay at the point of external disconnection can be used. When conducting the voltage decay measurement, the result is referred to an instrument having an input impedance consisting of a resistance of 100 $M\Omega \pm 5 M\Omega$ in parallel with an input capacitance of 20 pF ± 5 pF.

NOTE During an interval equal to one time constant, the voltage will have decayed to 37 % of its original value.

2.1.1.8 Energy hazards - d.c. mains supplies

Equipment shall be so designed that at an OPERATOR-accessible external point of disconnection of a DC MAINS SUPPLY, either

- there is no HAZARDOUS ENERGY LEVEL (for example, due to stored charge on a capacitor or a battery in the equipment, or to a redundant DC MAINS SUPPLY for backup), or
- the HAZARDOUS ENERGY LEVEL is removed within 2 s of the disconnection.

External points of disconnection include the plugs of PLUGGABLE EQUIPMENT and isolating switches external to the equipment.

Compliance is checked by inspection of the equipment and relevant circuit diagrams, taking into account the possibility of disconnection of the supply with any on/off switch in either position.

If necessary, the existence of a HAZARDOUS ENERGY LEVEL is determined as follows:

a) Capacitor connected to the DC MAINS SUPPLY

A test is conducted when the equipment is operating normally. The DC MAINS SUPPLY is then disconnected and the voltage across the capacitor (U) is measured 2 s after disconnection.

The stored energy is calculated from the following formula:

$$E = 0,5 CU^2 \times 10^{-6}$$

where

E is the energy, in joules (J);

C is the capacitance, in microfarads (μF);

U is the measured voltage on the capacitor, in volts (V).

A HAZARDOUS ENERGY LEVEL exists if the voltage, U , is 2 V or more, and the stored energy, E , exceeds 20 J.

b) Internal battery connected to the DC MAINS SUPPLY

A test is conducted with the DC MAINS SUPPLY disconnected and a variable resistive load connected to the input terminals where the DC MAINS SUPPLY is normally connected. The EUT is operated from its internal battery. The variable load is adjusted so that it draws 240 VA. Further adjustment is made, if necessary, to maintain 240 VA for a period of 60 s.

If U is more than 2 V, the output power is at a HAZARDOUS ENERGY LEVEL unless an overcurrent protective device opens during the above test, or for any other reason the power cannot be maintained at 240 VA for a period of 60 s.

If the output power is at a HAZARDOUS ENERGY LEVEL, a further test is conducted with the variable load disconnected and the EUT operated from the DC MAINS SUPPLY.

The supply is disconnected and the energy level at the input terminals, 2 s after disconnection, shall not be at a HAZARDOUS ENERGY LEVEL.

NOTE It is assumed that it will be possible to bridge the parts accidentally external to the equipment. There is no test to determine the likelihood of bridging the parts.

2.1.1.9 Audio amplifiers in information technology equipment

Accessible circuits, terminals and parts of audio amplifiers and associated circuits shall comply with either

- 2.1.1.1 of this standard, or
- 9.1.1 of IEC 60065.

Compliance is checked by inspection and, if necessary, by the tests of 9.1.1 of IEC 60065, during which the audio amplifiers are operated in accordance with 4.2.4 of IEC 60065.

2.1.2 Protection in service access areas

In a SERVICE ACCESS AREA, the following requirements apply.

The requirements of 2.1.1.7 apply to all types of equipment and for PERMANENTLY CONNECTED EQUIPMENT, the time constant limit is 10 s. In addition, the requirements of 2.1.1.8 apply.

Bare parts at HAZARDOUS VOLTAGES shall be located or guarded so that unintentional contact with such parts is unlikely during service operations involving other parts of the equipment.

Bare parts at HAZARDOUS VOLTAGE shall be located or guarded so that accidental shorting to SELV CIRCUITS or to TNV CIRCUITS (for example, by TOOLS or test probes used by a SERVICE PERSON) is unlikely.

No requirement is specified regarding access to ELV CIRCUITS or to TNV CIRCUITS. However, bare parts that present a HAZARDOUS ENERGY LEVEL shall be located or guarded so that unintentional bridging by conductive materials that might be present is unlikely during service operations involving other parts of the equipment.

Any guards required for compliance with 2.1.2 shall be easily removable and replaceable if removal is necessary for servicing.

Compliance is checked by inspection and measurement. In deciding whether or not unintentional contact is likely, account is taken of the way a SERVICE PERSON needs to gain access past, or near to, the bare parts in order to service other parts. For determination of a HAZARDOUS ENERGY LEVEL, see 2.1.1.5 c).

2.1.3 Protection in restricted access locations

For equipment to be installed in a RESTRICTED ACCESS LOCATION, the requirements for OPERATOR ACCESS AREAS apply, except as permitted in the following four paragraphs.

In general, the requirements of 2.1.1.7 and 2.1.1.8 apply except that they do not apply to PERMANENTLY CONNECTED EQUIPMENT. However, appropriate markings and instructions shall be provided for protection against energy hazards if a HAZARDOUS ENERGY LEVEL exists.

If a SECONDARY CIRCUIT at HAZARDOUS VOLTAGE is used to supply a ringing signal generator that complies with 2.3.1 b), contact with bare parts of the circuit is permitted with the test finger, Figure 2A (see 2.1.1.1). However, such parts shall be so located or guarded that unintentional contact is unlikely.

Bare parts that present a HAZARDOUS ENERGY LEVEL shall be located or guarded so that unintentional bridging by conductive materials that might be present is unlikely.

No requirement is specified regarding contact with bare parts of TNV-1 CIRCUITS, TNV-2 CIRCUITS and TNV-3 CIRCUITS.

Compliance is checked by inspection and measurement. In deciding whether or not unintentional contact is likely, account is taken of the need to gain access past, or near to, the bare parts. For determination of a HAZARDOUS ENERGY LEVEL, see 2.1.1.5 c).

2.2 SELV circuits

2.2.1 General requirements

SELV CIRCUITS shall exhibit voltages that are safe to touch both under normal operating conditions and after a single fault (see 1.4.14). If no external load is applied to the SELV CIRCUIT (open circuit), the voltage limits of 2.2.2 and 2.2.3 shall not be exceeded.

Compliance with 2.2.1 to 2.2.4 is checked by inspection and relevant tests.

2.2.2 Voltages under normal conditions

In a single SELV CIRCUIT or in interconnected SELV CIRCUITS, the voltage between any two conductors of the SELV CIRCUIT or CIRCUITS, and between any one such conductor and earth (see 1.4.9), shall not exceed 42,4 V peak, or 60 V d.c., under normal operating conditions.

NOTE 1 A circuit that meets the above requirements, but that is subject to overvoltages from a TELECOMMUNICATION NETWORK or a CABLE DISTRIBUTION SYSTEM, is a TNV-1 CIRCUIT.

NOTE 2 For normal conditions, the SELV CIRCUIT voltage limit is the same for an ELV CIRCUIT; an SELV CIRCUIT may be regarded as an ELV CIRCUIT with additional protection under fault conditions.

2.2.3 Voltages under fault conditions

Except as permitted in 2.3.2.1 b), in the event of a single fault (see 1.4.14), the voltages between any two conductors of the SELV CIRCUIT or CIRCUITS and between any one such conductor and earth (see 1.4.9) shall not exceed 42,4 V peak, or 60 V d.c. (V_1 in Figure 2E) for longer than 200 ms. Moreover, the voltage shall not exceed 71 V peak or 120 V d.c. (V_2 in Figure 2E).

Ⓢ Note deleted Ⓢ

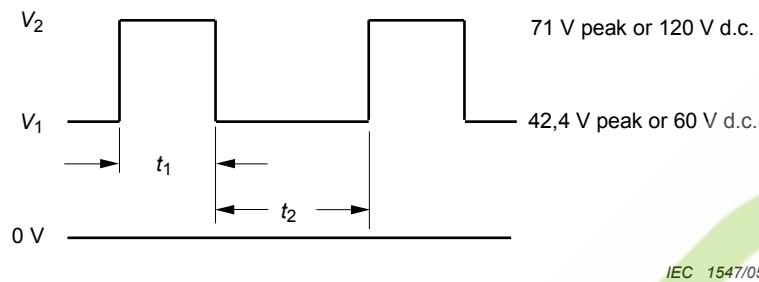

Figure 2E – Voltages in SELV circuits under single fault conditions

For voltages having a repetitive nature after a fault (for example, from power supplies in "hiccup" mode), additional pulses exceeding V_1 (but not exceeding V_2) are permitted under the following conditions:

- if $t_1 \leq 20$ ms, t_2 shall be greater than 1 s;
- if $t_1 > 20$ ms, t_2 shall be greater than 3 s; and
- t_1 shall not exceed 200 ms.

Only one pulse is permitted to exceed V_1 during time period t_1 , but it can have any waveform.

Except as permitted in 2.2.4, an SELV CIRCUIT shall be separated from a part at a HAZARDOUS VOLTAGE by one or more of the constructions specified in 2.9.4.

It is permitted for some parts of a circuit (for example, a transformer-rectifier circuit) to comply with all of the requirements for SELV CIRCUITS and to be OPERATOR-accessible, while other parts of the same circuit do not comply with all of the requirements for SELV CIRCUITS and are therefore not permitted to be OPERATOR-accessible.

2.2.4 Connection of SELV circuits to other circuits

An SELV CIRCUIT is permitted to be connected to other circuits provided that, when the SELV CIRCUIT is so connected, all of the following conditions are met:

- except as permitted by 1.5.7 and 2.4.3, the SELV CIRCUIT is separated by BASIC INSULATION from any PRIMARY CIRCUIT (including the neutral) within the equipment; and
- the SELV CIRCUIT meets the limits of 2.2.2 under normal operating conditions; and
- except as specified in 2.3.2.1 b), the SELV CIRCUIT meets the limits of 2.2.3 in the event of a single fault (see 1.4.14) in the SELV CIRCUIT or in the SECONDARY CIRCUIT to which the SELV CIRCUIT is connected.

If an SELV CIRCUIT is connected to one or more other circuits, the SELV CIRCUIT is that part which complies with the requirements of 2.2.2 and 2.2.3.

If an SELV CIRCUIT obtains its supply conductively from a SECONDARY CIRCUIT that is separated from a HAZARDOUS VOLTAGE circuit by either:

- DOUBLE INSULATION OR REINFORCED INSULATION; OR

- an earthed conductive screen that is separated from the HAZARDOUS VOLTAGE circuit by BASIC INSULATION,

the SELV CIRCUIT shall be considered as being separated from the HAZARDOUS VOLTAGE circuit by the same method.

Ⓒ Note deleted Ⓒ

If an SELV CIRCUIT is derived from a HAZARDOUS VOLTAGE SECONDARY CIRCUIT, and the HAZARDOUS VOLTAGE SECONDARY CIRCUIT is separated from the PRIMARY CIRCUIT by DOUBLE INSULATION or REINFORCED INSULATION, the SELV CIRCUIT shall remain within the limits given in 2.2.3 under single fault conditions (see 1.4.14). In such a case, the short-circuiting of the insulation in a transformer that provides the separation between the HAZARDOUS VOLTAGE SECONDARY CIRCUIT and the SELV CIRCUIT is considered to be a single fault, for the purpose of applying the single fault conditions, provided the insulation in the transformer passes an electrical strength test for BASIC INSULATION in accordance with 5.2.2.

2.3 TNV circuits

2.3.1 Limits

In a single TNV CIRCUIT or interconnected TNV CIRCUITS, the voltage between any two conductors of the TNV CIRCUIT or CIRCUITS and between any one such conductor and earth (see 1.4.9) shall comply with the following.

a) TNV-1 CIRCUITS

The voltages do not exceed the following:

- the voltage limits in 2.2.2 for an SELV CIRCUIT under normal operating conditions;
- the voltage limits of Figure 2F measured across a $5\,000\ \Omega \pm 2\%$ resistor in the event of a single fault (see 1.4.14) within the equipment.

NOTE 1 In the event of a single insulation or component failure, the limit after 200 ms is the limit in 2.3.1 b) for a TNV-2 CIRCUIT or TNV-3 CIRCUIT for normal operating conditions.

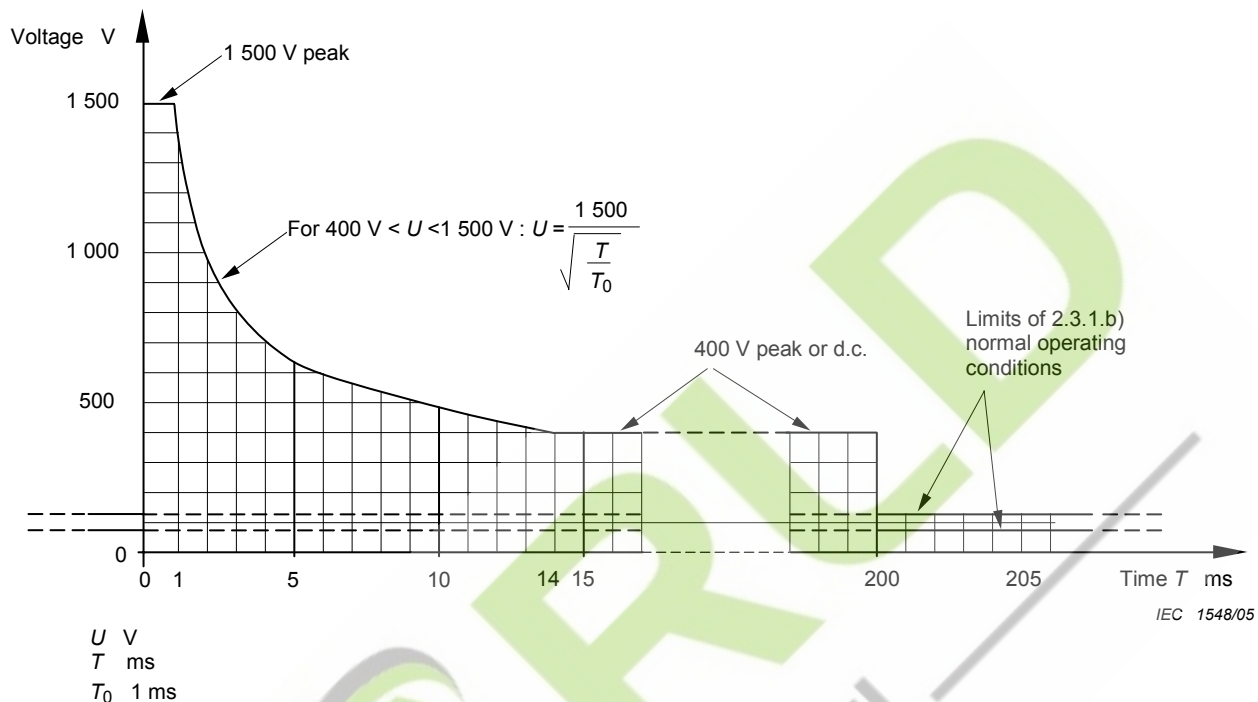

Figure 2F – Maximum voltages permitted after a single fault

b) TNV-2 CIRCUITS and TNV-3 CIRCUITS

The voltages exceed the limits in 2.2.2 for an SELV CIRCUIT but do not exceed the following:

- when telephone ringing signals are present, voltages such that the signal complies with the criteria of either Clause M.2 or Clause M.3;
- when telephone ringing signals are not present:
 - a combination of voltages, a.c. and d.c., such that under normal operating conditions:

$$\frac{U_{ac}}{71} + \frac{U_{dc}}{120} \leq 1$$

where

U_{ac} is the peak value of the a.c. voltage (V) at any frequency;

U_{dc} is the value of the DC VOLTAGE (V)

NOTE 2 When U_{dc} is zero, U_{ac} can be up to 71 V peak.

NOTE 3 When U_{ac} is zero, U_{dc} can be up to 120 V.

and

- the voltage limits of Figure 2F measured across a $5\,000\ \Omega \pm 2\%$ resistor in the event of a single fault (see 1.4.14) within the equipment.

Compliance is checked by inspection and measurement.

NOTE 4 Telegraph and teletypewriter signals may be present on existing TELECOMMUNICATION NETWORKS. However, these signals are considered to be obsolescent and their characteristics are not considered in this standard.

2.3.2 Separation of TNV circuits from other circuits and from accessible parts

[C] Note deleted **[C]**

2.3.2.1 General requirements

NOTE 1 See also 6.1.2, 6.2 and 7.3.

SELV-CIRCUITS, TNV-1 CIRCUITS and accessible conductive parts shall be separated from TNV-2 CIRCUITS and TNV-3 CIRCUITS in such a way that in the event of a single fault (see 1.4.14) both of the following conditions are met:

- a) the voltages of TNV-1 CIRCUITS do not exceed the limits of Figure 2F; and
- b) the voltages of the SELV CIRCUITS and accessible conductive parts do not exceed the limits specified in 2.3.1 b) for TNV-2 CIRCUITS and TNV-3 CIRCUITS under normal operating conditions.

[C] Note deleted **[C]**

NOTE 3 Under normal operating conditions, the limits of 2.2.2 always apply to each SELV CIRCUIT and accessible conductive part.

NOTE 4 The limits of 2.3.1 always apply to each TNV CIRCUIT.

At the choice of the manufacturer, it is permitted to treat a TNV-1 CIRCUIT or a TNV-2 CIRCUIT as a TNV-3 CIRCUIT. In this case, the TNV-1 CIRCUIT or TNV-2 CIRCUIT shall meet all the separation requirements for a TNV-3 CIRCUIT.

One of the methods specified in 2.3.2.2, 2.3.2.3, 2.3.2.4 and 2.10.5.13 shall be used.

Compliance is checked as specified in 2.3.2.2, 2.3.2.3, 2.3.2.4 or 2.10.5.13.

2.3.2.2 Protection by basic insulation

The requirements of 2.3.2.1 are met if the parts are separated by BASIC INSULATION.

Compliance is checked by inspection, measurement and electric strength testing of the BASIC INSULATION and, if necessary, by simulation of failures of components and the BASIC INSULATION (see 1.4.14). However, if it is clear from a study of the circuit diagrams that the specified limits of 2.3.1 b) will not be exceeded, failure of components and the BASIC INSULATION need not be simulated.

NOTE 1 The test of 2.3.5 is not required.

NOTE 2 Where BASIC INSULATION is provided and 6.2.1 also applies to this insulation, the test voltage prescribed in 6.2.2 is in most cases higher than that for BASIC INSULATION.

2.3.2.3 Protection by earthing

The requirements of 2.3.2.1 are considered to be met if the SELV CIRCUIT, TNV-1 CIRCUIT or accessible conductive part is connected to the main protective earthing terminal in accordance with 2.6.1 c) or d); and one of the following, a), b), c) or d) applies.

- a) For PLUGGABLE EQUIPMENT, a separate protective earthing terminal is provided in addition to the main protective earthing terminal, if any (see 2.6.4.1). The installation instructions shall specify that this separate protective earthing terminal be permanently connected to earth.

- b) For PLUGGABLE EQUIPMENT TYPE B, having connections to TELECOMMUNICATION NETWORKS or to CABLE DISTRIBUTION SYSTEMS that are all pluggable, a marking on the equipment and a statement in the installation instructions shall be provided. These shall specify that the USER is to disconnect all TELECOMMUNICATION NETWORK connectors and CABLE DISTRIBUTION SYSTEM connectors before disconnecting the POWER SUPPLY CORD.
- c) For PLUGGABLE EQUIPMENT TYPE A, the requirements of b) above apply, and in addition the installation instructions shall specify that it be installed by a SERVICE PERSON and connected to a socket-outlet with a protective earthing contact.
- d) For PERMANENTLY CONNECTED EQUIPMENT there is no additional requirement.

NOTE If earthing is provided that is not in accordance with a), b), c) or d), see 2.3.2.4.

Compliance is checked by inspection and, if necessary, by simulation of failures of components and insulation such as are likely to occur in the equipment (see 1.4.14). The voltage limits specified in 2.3.2.1 shall be met.

Additionally, the test of 2.3.5 shall be conducted if the TNV-2 CIRCUIT or TNV-3 CIRCUIT is intended to receive signals or power that are generated externally during normal operation (for example, in a TELECOMMUNICATION NETWORK). Single faults are not simulated while conducting the test of 2.3.5.

Prior to the above tests, insulation that does not meet the requirements for BASIC INSULATION is short-circuited. However, if simulation of failures would be more severe if conducted without short-circuiting the insulation, the test is conducted without short-circuiting.

2.3.2.4 Protection by other constructions

Other constructions are permitted if they ensure that the voltage limits specified in 2.3.2.1 are met, but do not rely on BASIC INSULATION or earthing, or by separation as specified in 2.10.5.13.

Compliance is checked by simulation of failures of components and insulation such as are likely to occur in the equipment (see 1.4.14).

If earthing is provided that is not in accordance with 2.3.2.3 a), b), c) or d), the tests are conducted with the EUT not connected to earth. The voltage limits specified in 2.3.2.1 shall be met.

Additionally, the test of 2.3.5 shall be conducted if the TNV-2 CIRCUIT or TNV-3 CIRCUIT is intended to receive signals or power that are generated externally during normal operation (for example, in a TELECOMMUNICATION NETWORK). Single faults are not simulated while conducting the test of 2.3.5.

Prior to the above tests, insulation that does not meet the requirements for BASIC INSULATION is short-circuited. However, if simulation of failures would be more severe if conducted without short-circuiting the insulation, the test is conducted without short-circuiting.

2.3.3 Separation from hazardous voltages

Except as permitted in 2.3.4, a TNV CIRCUIT shall be separated from circuits at HAZARDOUS VOLTAGE by one or more of the constructions specified in 2.9.4.

Compliance is checked by inspection and measurement.

2.3.4 Connection of TNV circuits to other circuits

Except as permitted in 1.5.7, a TNV CIRCUIT is permitted to be connected to other circuits, provided that it is separated by BASIC INSULATION from any PRIMARY CIRCUIT (including the neutral) within the equipment.

NOTE 1 The limits of 2.3.1 always apply to TNV CIRCUITS.

If a TNV CIRCUIT is connected to one or more other circuits, the TNV CIRCUIT is that part which complies with 2.3.1.

If a TNV CIRCUIT obtains its supply conductively from a SECONDARY CIRCUIT that is separated from a HAZARDOUS VOLTAGE circuit by:

- DOUBLE INSULATION OR REINFORCED INSULATION; OR
- the use of an earthed conductive screen that is separated from a HAZARDOUS VOLTAGE circuit by BASIC INSULATION;

the TNV CIRCUIT shall be considered as being separated from the HAZARDOUS VOLTAGE circuit by the same method.

If a TNV CIRCUIT is derived from a HAZARDOUS VOLTAGE SECONDARY CIRCUIT, and the HAZARDOUS VOLTAGE SECONDARY CIRCUIT is separated from the PRIMARY CIRCUIT by DOUBLE INSULATION OR REINFORCED INSULATION, the TNV CIRCUIT shall remain within the limits given in 2.3.1 under single fault conditions (see 1.4.14). In such a case, the short-circuiting of the insulation in a transformer that provides the separation between the HAZARDOUS VOLTAGE SECONDARY CIRCUIT and the TNV CIRCUIT is considered to be a single fault, for the purpose of applying the single fault conditions, provided the insulation in the transformer passes an electrical strength test for BASIC INSULATION in accordance with 5.2.2.

Compliance is checked by inspection, and by simulation of single faults (see 1.4.14) such as are likely to occur in the equipment. No such simulated fault shall cause the voltage across a $5\,000\ \Omega \pm 2\%$ resistor, connected between any two conductors of the TNV CIRCUIT or between one such conductor and earth, to fall outside the shaded area of Figure 2F (see 2.3.1). Observation is continued until stable conditions have existed for at least 5 s.

 Note deleted 

2.3.5 Test for operating voltages generated externally

This test is only conducted if specified in 2.3.2.3 or 2.3.2.4.

A test generator specified by the manufacturer is used, representing the maximum normal operating voltage expected to be received from the external source. In the absence of such a specification, a test generator is used that provides $120\text{ V} \pm 2\text{ V a.c.}$ at 50 Hz or 60 Hz and has an internal impedance of $1\,200\ \Omega \pm 2\%$.

NOTE The above test generator is not intended to represent the actual voltages on the TELECOMMUNICATION NETWORK but to stress the circuit of the EUT in a repeatable manner.

The test generator is connected between the TELECOMMUNICATION NETWORK terminals of the equipment. One pole of the test generator is also connected to the earthing terminal of the equipment (see Figure 2G). The test voltage is applied for a maximum of 30 min. If it is clear that no further deterioration will take place, the test is terminated earlier.

During the test, the SELV CIRCUIT, TNV-1 CIRCUIT or accessible conductive part shall continue to comply with 2.2.2.

The test is repeated after reversing the connections to the TELECOMMUNICATION NETWORK terminals of the equipment.

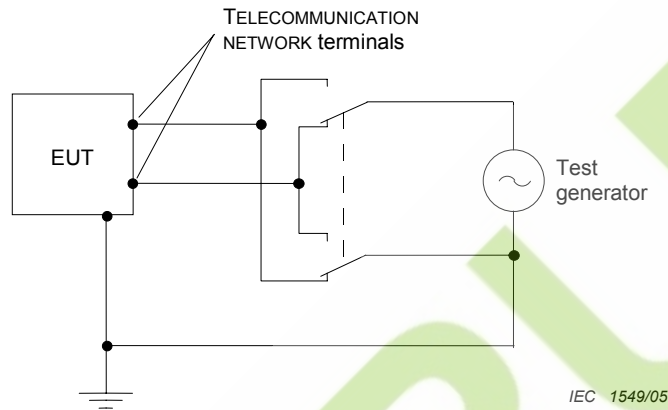

Figure 2G – Test generator

2.4 Limited current circuits

2.4.1 General requirements

LIMITED CURRENT CIRCUITS shall be so designed that the limits specified in 2.4.2 are not exceeded under normal operating conditions and in the event of a single failure within the equipment (see 1.4.14 and 1.5.7).

Except as permitted in 2.4.3, segregation of accessible parts of LIMITED CURRENT CIRCUITS from other circuits shall be as described in 2.2 for SELV CIRCUITS.

Compliance with 2.4.1 to 2.4.3 is checked by inspection, measurement and, when necessary, by test.

NOTE An accessible conductive part or circuit separated from another part by DOUBLE INSULATION or REINFORCED INSULATION that is bridged by a resistor or group of resistors is treated as a LIMITED CURRENT CIRCUIT (see 1.5.7).

2.4.2 Limit values

For frequencies not exceeding 1 kHz, the steady-state current drawn through a non-inductive resistor of $2\,000\ \Omega \pm 10\%$ connected between any two parts of a LIMITED CURRENT CIRCUIT, or between any such part and earth (see 1.4.9), shall not exceed 0,7 mA peak, or 2 mA d.c.

For frequencies above 1 kHz, the limit of 0,7 mA is multiplied by the value of the frequency in kilohertz but shall not exceed 70 mA peak.

Alternatively, it is permitted to use the measuring instruments of Annex D instead of the non-inductive resistor of $2\,000\ \Omega \pm 10\%$ mentioned above.

When using the measuring instrument of Figure D.1, the voltage, U_2 , is measured and the current is calculated by dividing the measured voltage, U_2 , by 500. The calculated value shall not exceed 0,7 mA peak.

NOTE 1 If one side of the LIMITED CURRENT CIRCUIT has a conductive connection to earth, point B of the measuring instrument of Figure D.1 should be connected to that side.

When using the measuring instrument of Figure D.2, the measured value of the current shall not exceed 0,7 mA peak.

For parts not exceeding 450 V peak or d.c., the circuit capacitance shall not exceed 0,1 μ F.

For parts whose voltage, U , exceeds 0,45 kV peak or d.c., but does not exceed 15 kV peak or d.c., the circuit capacitance shall not exceed $45/U$ nF, where U is expressed in kilovolts.

NOTE 2 The limit of $45/U$ corresponds to an available stored charge of 45 μ C.

For parts whose voltage, U , exceeds 15 kV peak or d.c., the circuit capacitance shall not exceed $700/U^2$ nF, where U is expressed in kilovolts.

NOTE 3 The limit of $700/U^2$ corresponds to an available energy of 350 mJ.

2.4.3 Connection of limited current circuits to other circuits

LIMITED CURRENT CIRCUITS are permitted to be supplied from or connected to other circuits, provided that the following conditions are met:

- the LIMITED CURRENT CIRCUIT meets the limits of 2.4.2 under normal operating conditions;
- the LIMITED CURRENT CIRCUIT continues to meet the limits of 2.4.2 in the event of a single failure of any component or insulation in the LIMITED CURRENT CIRCUIT, or of any component or insulation in the other circuit to which it is connected.

If a LIMITED CURRENT CIRCUIT is connected to one or more other circuits, the LIMITED CURRENT CIRCUIT is that part which complies with the requirements of 2.4.1.

2.5 Limited power sources

A limited power source shall comply with one of the following, a), b), c) or d):

- a) the output is inherently limited in compliance with Table 2B; or
- b) a linear or non-linear impedance limits the output in compliance with Table 2B. If a positive temperature coefficient device is used, it shall pass the tests specified in IEC 60730-1, Clauses 15, 17, J.15 and J.17; or
- c) a regulating network limits the output in compliance with Table 2B, both with and without a simulated single fault (see 1.4.14) in the regulating network (open circuit or short-circuit); or
- d) an overcurrent protective device is used and the output is limited in compliance with Table 2C.

Where an overcurrent protective device is used, it shall be a fuse or a non-adjustable, non-autoreset, electromechanical device.

A limited power source operated from an AC MAINS SUPPLY, or a battery-operated limited power source that is recharged from an AC MAINS SUPPLY while supplying the load, shall incorporate an isolating transformer.

Compliance is checked by inspection and measurement and, where appropriate, by examination of the manufacturer's data for batteries. Batteries shall be fully charged when conducting the measurements for U_{oc} and I_{sc} according to Tables 2B and 2C.

The non-capacitive load referred to in Tables 2B and 2C is adjusted to give the maximum measured value of I_{sc} or S .

Simulated faults in a regulating network, required according to item c) above, are applied under the above maximum measured values of I_{sc} or S .

Table 2B – Limits for power sources without an overcurrent protective device

| Output voltage ^a (U_{oc}) | | Output current ^{b d} (I_{sc}) | Apparent power ^{c d} (S) |
|---|--------------------|---|--|
| V a.c. | V d.c. | A | VA |
| ≤ 30 | ≤ 30 | ≤ 8,0 | ≤ 100 |
| – | 30 < U_{oc} ≤ 60 | ≤ 150/ U_{oc} | ≤ 100 |

^a U_{oc} : Output voltage measured in accordance with 1.4.5 with all load circuits disconnected. Voltages are for substantially sinusoidal a.c. and ripple free d.c. For non-sinusoidal a.c. and d.c. with ripple greater than 10 % of the peak, the peak voltage shall not exceed 42,4 V.

^b I_{sc} : Maximum output current with any non-capacitive load, including a short-circuit.

^c S (VA): Maximum output VA with any non-capacitive load.

^d Measurement of I_{sc} and S are made 5 s after application of the load if protection is by an electronic circuit or a positive temperature coefficient device, and 60 s in other cases.

Table 2C – Limits for power sources with an overcurrent protective device

| Output voltage ^a (U_{oc}) | | Output current ^{b d} (I_{sc}) | Apparent power ^{c d} (S) | Current rating of overcurrent protective device ^e |
|---|--------------------|---|--|--|
| V a.c. | V d.c. | A | VA | A |
| ≤ 20 | ≤ 20 | ≤ 1 000/ U_{oc} | ≤ 250 | ≤ 5,0 |
| 20 < U_{oc} ≤ 30 | 20 < U_{oc} ≤ 30 | | | ≤ 100/ U_{oc} |
| – | 30 < U_{oc} ≤ 60 | | | ≤ 100/ U_{oc} |

^a U_{oc} : Output voltage measured in accordance with 1.4.5 with all load circuits disconnected. Voltages are for substantially sinusoidal a.c. and ripple free d.c. For non-sinusoidal a.c. and for d.c. with ripple greater than 10 % of the peak, the peak voltage shall not exceed 42,4 V.

^b I_{sc} : Maximum output current with any non-capacitive load, including a short-circuit, measured 60 s after application of the load.

^c S (VA): Maximum output VA with any non-capacitive load measured 60 s after application of the load.

^d Current limiting impedances remain in the circuit during measurement, but overcurrent protective devices are bypassed.
NOTE The reason for making measurements with overcurrent protective devices bypassed is to determine the amount of energy that is available to cause possible overheating during the operating time of the overcurrent protective devices.

^e The current ratings of overcurrent protective devices are based on fuses and circuit-breakers that break the circuit within 120 s with a current equal to 210 % of the current rating specified in the table.

2.6 Provisions for earthing and bonding

NOTE For additional requirements with regard to earthing of equipment to be connected to TELECOMMUNICATION NETWORKS, see 2.3.2.3, 2.3.2.4, 2.3.3, 2.3.4, 6.1.1 and 6.1.2; and for CABLE DISTRIBUTION SYSTEMS, see 7.2 and 7.4.1.

2.6.1 Protective earthing

The following parts of equipment shall be reliably connected to the main protective earthing terminal of the equipment.

- a) Accessible conductive parts that might assume a HAZARDOUS VOLTAGE in the event of a single fault (see 1.4.14).
- b) Parts to be earthed as required by 2.9.4 d) or e).
- c) SELV CIRCUITS, TNV CIRCUITS and accessible conductive parts required to be earthed by 2.3.2.3 or 2.3.2.4, if the power source is not a TELECOMMUNICATION NETWORK or a CABLE DISTRIBUTION SYSTEM.
- d) SELV CIRCUITS, TNV CIRCUITS and accessible conductive parts required to be earthed by 2.3.2.3, if the power source is a TELECOMMUNICATION NETWORK or a CABLE DISTRIBUTION SYSTEM.
- e) Circuits, transformer screens and components (such as surge suppressors) that could not assume a HAZARDOUS VOLTAGE in the event of a single fault (see 1.4.14) but are required to be earthed in order to reduce transients that might affect insulation (for example, see 6.2.1 and 7.4.1).
- f) SELV CIRCUITS and TNV CIRCUITS that are required to be earthed in order to reduce or eliminate TOUCH CURRENT to a TELECOMMUNICATION NETWORK or a CABLE DISTRIBUTION SYSTEM (see 5.1.8.1).

NOTE Parts a), b) and c) are likely to carry fault currents intended to operate overcurrent protective devices. Parts d), e) and f) carry other currents.

In SERVICE ACCESS AREAS, where conductive parts, such as motor frames, electronic chassis, etc., might assume a HAZARDOUS VOLTAGE in the event of a single fault (see 1.4.14), either these conductive parts shall be connected to the main protective earthing terminal or, if this is impossible or impracticable, a suitable marking shall indicate to a SERVICE PERSON that such parts are not earthed and should be checked for HAZARDOUS VOLTAGE before being touched.

Compliance is checked by inspection and, where appropriate, by the test specified in 2.6.3.

2.6.2 Functional earthing

If FUNCTIONAL EARTHING of accessible or inaccessible conductive parts is necessary, all of the following apply to the FUNCTIONAL EARTHING circuit:

- the FUNCTIONAL EARTHING circuit shall be separated from parts at HAZARDOUS VOLTAGES in the equipment by either:
 - DOUBLE INSULATION OR REINFORCED INSULATION; OR
 - a protectively earthed screen or another protectively earthed conductive part, separated from parts at HAZARDOUS VOLTAGES by at least BASIC INSULATION; and
- it is permitted to connect the FUNCTIONAL EARTHING circuit to a protective earth terminal or to a PROTECTIVE BONDING CONDUCTOR; and

- wiring terminals to be used only for FUNCTIONAL EARTHING shall not be marked by the symbol \perp (60417-IEC-5017) or by the symbol \oplus (60417-IEC-5019), except that, where a wiring terminal is provided on a component (for example, a terminal block) or subassembly, the symbol \perp is permitted; and

NOTE Other markings such as one of the symbols, \perp (IEC 60417-5018 (DB:2002-10)) or \perp (IEC 60417-5020 (DB:2002-10)), if appropriate, are permitted.

- for internal FUNCTIONAL EARTHING conductors, the colour combination green-and-yellow shall not be used except in multipurpose preassembled components (for example, multi-conductor cables or EMC filters); and
- in a power supply cord where a conductor having green-and-yellow insulation is used only to provide a FUNCTIONAL EARTHING connection:
 - the equipment shall not be marked with the symbol \square (IEC 60417-5172 (DB:2003:02)); and
 - there are no requirements other than those in 3.1.9 regarding the termination of this conductor at the equipment end.

Compliance is checked by inspection.

2.6.3 Protective earthing conductors and protective bonding conductors

2.6.3.1 General

PROTECTIVE EARTHING CONDUCTORS and PROTECTIVE BONDING CONDUCTORS shall have sufficient current-carrying capacity.

The requirements of 2.6.3.2, 2.6.3.3 and 2.6.3.4 apply to PROTECTIVE EARTHING CONDUCTORS and PROTECTIVE BONDING CONDUCTORS provided to comply with 2.6.1 a), b) and c).

For PROTECTIVE EARTHING CONDUCTORS and PROTECTIVE BONDING CONDUCTORS provided to comply with 2.6.1 d), the requirements and test of 2.6.3.4 e) apply.

For PROTECTIVE EARTHING CONDUCTORS and PROTECTIVE BONDING CONDUCTORS provided to comply with 2.6.1 e) and 2.6.1 f), and for FUNCTIONAL EARTHING conductors, the current-carrying capacity shall be adequate for the actual current under normal operating conditions, in accordance with 3.1.1, that is the conductors are not required to carry fault currents to earth.

2.6.3.2 Size of protective earthing conductors

PROTECTIVE EARTHING CONDUCTORS in power supply cords supplied with the equipment shall comply with the minimum conductor sizes in Table 3B (see 3.2.5).

Compliance is checked by inspection and measurement.

2.6.3.3 Size of protective bonding conductors



PROTECTIVE BONDING CONDUCTORS shall comply with one of the following:

- the minimum conductor sizes in Table 3B (see 3.2.5); or
- the requirements of 2.6.3.4 and also, if the PROTECTIVE CURRENT RATING of the circuit is more than 16 A, with the minimum conductor sizes in Table 2D; or
- for components only, be not smaller than the conductors supplying power to the component.

The PROTECTIVE CURRENT RATING of the circuit (used in Table 2D and in the test of 2.6.3.4) depends on the provision and location of overcurrent protective devices. It shall be taken as the smallest of a) or b) or c), as applicable.

- a) For PLUGGABLE EQUIPMENT TYPE A, the PROTECTIVE CURRENT RATING is the rating of an overcurrent protective device provided external to the equipment (for example, in the building wiring, in the mains plug or in an equipment rack) to protect the equipment, with a minimum of 16 A.

NOTE 1 In most countries, 16 A is considered to be suitable as the PROTECTIVE CURRENT RATING of the circuit.

 Notes deleted 

- b) For PLUGGABLE EQUIPMENT TYPE B and PERMANENTLY CONNECTED EQUIPMENT (see 2.7.1), the PROTECTIVE CURRENT RATING is the maximum rating of the overcurrent protective device specified in the equipment installation instructions to be provided external to the equipment (see 1.7.2.3).
- c) For any of the above equipment, the PROTECTIVE CURRENT RATING is the rating of an overcurrent protective device, if provided in or as part of the equipment, that protects the circuit or part required to be earthed.

Compliance is checked by inspection and measurement.

Table 2D – Minimum size of protective bonding conductors

| PROTECTIVE CURRENT RATING of the circuit under consideration Up to and including A | Minimum conductor sizes | |
|--|---|--|
| | Cross-sectional area mm ² | AWG or kcmil (cross-sectional area in mm ²) |
| 16 | Size not specified | Size not specified |
| 25 | 1,5 | 14 (2) |
| 32 | 2,5 | 12 (3) |
| 40 | 4,0 | 10 (5) |
| 63 | 6,0 | 8 (8) |
| 80 | 10 | 6 (13) |
| 100 | 16 | 4 (21) |
| 125 | 25 | 2 (33) |
| 160 | 35 | 1 (42) |
| 190 | 50 | 0 (53) |
| 230 | 70 | 000 (85) |
| 260 | 95 | 0000 (107) |
| 300 | 120 | 250 kcmil (126) |
| 340 | 150 | 300 kcmil (152) |
| 400 | 185 | 400 kcmil (202) |
| 460 | 240 | 500 kcmil (253) |

NOTE AWG and kcmil sizes are provided for information only. The associated cross-sectional areas have been rounded to show significant figures only. AWG refers to the American Wire Gage and the term "cmil" refers to circular mils where 1 cmil is the area of a circle having a diameter of 1 mil (one thousandth of an inch). These terms are commonly used to designate wire sizes in North America.

2.6.3.4 Resistance of earthing conductors and their terminations

Earthing conductors and their terminations shall not have excessive resistance.

PROTECTIVE EARTHING CONDUCTORS are considered to comply without test.

PROTECTIVE BONDING CONDUCTORS that meet the minimum conductor sizes in Table 3B (see 3.2.5) throughout their length and whose terminals all meet the minimum sizes in Table 3E (see 3.3.5) are considered to comply without test.

Compliance is checked by inspection, measurement and, for PROTECTIVE BONDING CONDUCTORS that do not meet the minimum conductor sizes in Table 3B (see 3.2.5) throughout their length or whose terminals do not all meet the minimum sizes in Table 3E (see 3.3.5), by the following test.

The voltage drop in a PROTECTIVE BONDING CONDUCTOR is measured after conducting the test current for the time period specified below. The test current can be either a.c. or d.c. and the test voltage shall not exceed 12 V. The measurement is made between the main protective earthing terminal and the point in the equipment that is required by 2.6.1 to be earthed. The resistance of the PROTECTIVE EARTHING CONDUCTOR is not included in the measurement. However, if the PROTECTIVE EARTHING CONDUCTOR is supplied with the equipment, it is permitted to include the conductor in the test circuit but the measurement of the voltage drop is made only from the main protective earthing terminal to the part required to be earthed.

On equipment where the protective earth connection to a subassembly or to a separate unit is by means of one core of a multicore cable that also supplies mains power to that subassembly or unit, the resistance of the PROTECTIVE BONDING CONDUCTOR in that cable is not included in the measurement. However, this option is only permitted if the cable is protected by a suitably rated protective device that takes into account the size of the conductor.

If the protection of an SELV CIRCUIT or a TNV CIRCUIT is achieved by earthing the protected circuit itself in accordance with 2.9.4 e), the resistance and the voltage drop limits apply between the earthed side of the protected circuit and the main protective earthing terminal.

If the circuit is protected by earthing the winding of a transformer supplying the protected circuit, the resistance and the voltage drop limits apply between the unearthed side of the winding and the main protective earthing terminal. The BASIC INSULATION between the primary and secondary windings is not subjected to the single fault testing required by 5.3.7 and 1.4.14.

Care is taken that the contact resistance between the tip of the measuring probe and the conductive part under test does not influence the test results.

The test current, duration of the test and test results are as follows:

- a) For equipment powered from a MAINS SUPPLY, if the PROTECTIVE CURRENT RATING of the circuit under test (see 2.6.3.3) is 16 A or less, the test current is 200 % of the PROTECTIVE CURRENT RATING applied for 120 s.

The resistance of the PROTECTIVE BONDING CONDUCTOR, calculated from the voltage drop, shall not exceed 0,1 Ω. After the test, the PROTECTIVE BONDING CONDUCTOR shall not be damaged.

- b) For equipment powered from an AC MAINS SUPPLY, if the PROTECTIVE CURRENT RATING of the circuit under test exceeds 16 A, the test current is 200 % of the PROTECTIVE CURRENT RATING and the duration of the test is as shown in Table 2E.

Table 2E – Test duration, a.c. mains supplies

| PROTECTIVE CURRENT RATING of the circuit (I_{pc}) A | Duration of the test min |
|---|-----------------------------|
| ≤ 30 | 2 |
| $30 < I_{pc} \leq 60$ | 4 |
| $60 < I_{pc} \leq 100$ | 6 |
| $100 < I_{pc} \leq 200$ | 8 |
| > 200 | 10 |

The voltage drop in the PROTECTIVE BONDING CONDUCTOR shall not exceed 2,5 V. After the test the PROTECTIVE BONDING CONDUCTOR shall not be damaged.

- c) As an alternative to b) above, the tests are based on the time-current characteristic of the overcurrent protective device that limits the fault current in the PROTECTIVE BONDING CONDUCTOR. This device is either one provided in the EUT or specified in the installation instructions to be provided external to the equipment. The tests are conducted at 200 % of the PROTECTIVE CURRENT RATING, for the duration corresponding to 200 % on the time-current characteristic. If the duration for 200 % is not given, the nearest point on the time-current characteristic is used.

The voltage drop in the PROTECTIVE BONDING CONDUCTOR shall not exceed 2,5 V. After the test the PROTECTIVE BONDING CONDUCTOR shall not be damaged.

- d) For equipment powered from a DC MAINS SUPPLY, if the PROTECTIVE CURRENT RATING of the circuit under test exceeds 16 A, the test current and duration are as specified by the manufacturer.

The voltage drop in the PROTECTIVE BONDING CONDUCTOR shall not exceed 2,5 V. After the test the PROTECTIVE BONDING CONDUCTOR shall not be damaged.

- e) For PROTECTIVE BONDING CONDUCTORS provided to comply with 2.6.1 d), the test current is 150 % of the maximum current available under normal operating conditions from the TELECOMMUNICATION NETWORK or CABLE DISTRIBUTION SYSTEM (if known) with a minimum of 2 A, applied for 120 s. The voltage drop in the PROTECTIVE BONDING CONDUCTOR shall not exceed 2,5 V.

2.6.3.5 Colour of insulation

The insulation of the PROTECTIVE EARTHING CONDUCTOR in a power supply cord supplied with the equipment shall be green-and-yellow.

If a PROTECTIVE BONDING CONDUCTOR is insulated, the insulation shall be green-and-yellow except in the following two cases:

- for an earthing braid, the insulation shall be either green-and-yellow or transparent;
- for a PROTECTIVE BONDING CONDUCTOR in assemblies such as ribbon cables, busbars, printed wiring, etc., any colour is permitted provided that no misinterpretation of the use of the conductor is likely to arise.

Except as permitted in 2.6.2, the colour combination green-and-yellow shall be used only to identify PROTECTIVE EARTHING CONDUCTORS and PROTECTIVE BONDING CONDUCTORS.

Compliance is checked by inspection.

2.6.4 Terminals

2.6.4.1 General

The requirements of 2.6.4.2 and 2.6.4.3 apply only to protective earthing terminals provided to comply with 2.6.1 a), b) and c).

NOTE For additional requirements concerning terminals, see 3.3.

For protective earthing provided to comply with 2.6.1 d), e) and f), it is sufficient for the terminals to comply with 3.3.

2.6.4.2 Protective earthing and bonding terminals

Equipment required to have protective earthing shall have a main protective earthing terminal. For equipment with a DETACHABLE POWER SUPPLY CORD, the earthing terminal in the appliance inlet is regarded as the main protective earthing terminal.

If equipment is provided with more than one supply connection (for example, with different voltages or frequencies or as backup power), it is permitted to have a main protective earthing terminal associated with each supply connection. In such a case, the terminals shall be sized according to the rating of the associated supply input.

Terminals shall be designed to resist accidental loosening of the conductor. In general, the designs commonly used for current-carrying terminals, other than some terminals of the pillar type, provide sufficient resilience to comply with this requirement; for other designs, special provisions, such as the use of an adequately resilient part that is not likely to be removed inadvertently, shall be used.

Except as noted below, all pillar, stud or screw type protective earthing and protective bonding terminals shall comply with the minimum size requirements of Table 3E (see 3.3.5).

Where a terminal for a PROTECTIVE BONDING CONDUCTOR does not comply with Table 3E (see 3.3.5), the test of 2.6.3.4 shall be applied to the PROTECTIVE BONDING CONDUCTOR path in which the terminal is used.

The main protective earthing terminal for PERMANENTLY CONNECTED EQUIPMENT shall be

- located so that it is readily accessible while making the supply connections, and
- provided with factory installed pillar terminals, studs, screws, bolts or similar terminals, together with the necessary fixing hardware, if a PROTECTIVE EARTHING CONDUCTOR larger than 7 mm² (3 mm diameter) is required.

Compliance is checked by inspection and measurement.

2.6.4.3 Separation of the protective earthing conductor from protective bonding conductors

Separate wiring terminals, which may be on the same busbar, shall be provided, one for the PROTECTIVE EARTHING CONDUCTOR, or one for each PROTECTIVE EARTHING CONDUCTOR if more than one is provided, and one or more for PROTECTIVE BONDING CONDUCTORS.

However, it is permitted to provide a single wiring terminal of the screw or stud type in PERMANENTLY CONNECTED EQUIPMENT having a NON-DETACHABLE POWER SUPPLY CORD, and in PLUGGABLE EQUIPMENT having a special NON-DETACHABLE POWER SUPPLY CORD, provided that the wiring termination of the PROTECTIVE EARTHING CONDUCTOR is separated by a nut from that of the PROTECTIVE BONDING CONDUCTORS. The order of stacking of the terminations of the PROTECTIVE EARTHING CONDUCTOR and the PROTECTIVE BONDING CONDUCTORS is not specified.

It is also permitted to provide a single wiring terminal in equipment with an appliance inlet.

Compliance is checked by inspection.

2.6.5 Integrity of protective earthing

2.6.5.1 Interconnection of equipment

In a system of interconnected equipment, the protective earthing connection shall be ensured for all equipment requiring a protective earthing connection, regardless of the arrangement of equipment in the system.

Equipment that contains a PROTECTIVE BONDING CONDUCTOR to maintain continuity of protective earthing circuits to other equipment in the system, shall not be marked with the symbol (IEC 60417-5172 (DB:2003-02)).

Such equipment shall also provide power to the other equipment in the system (see 2.6.5.3).

Compliance is checked by inspection.

2.6.5.2 Components in protective earthing conductors and protective bonding conductors

PROTECTIVE EARTHING CONDUCTORS and PROTECTIVE BONDING CONDUCTORS shall not contain switches or overcurrent protective devices.

Compliance is checked by inspection.

2.6.5.3 Disconnection of protective earth

Protective earthing connections shall be such that disconnection of a protective earth at one point in a unit or a system does not break the protective earthing connection to other parts or units in a system, unless the relevant hazard is removed at the same time.

Compliance is checked by inspection.

2.6.5.4 Parts that can be removed by an operator

Protective earthing connections shall make earlier and break later than the supply connections in each of the following:

- the connector of a part that can be removed by an OPERATOR;
- a plug on a power supply cord;
- an appliance coupler.

Compliance is checked by inspection.

2.6.5.5 Parts removed during servicing

Protective earthing connections shall be so designed that they do not have to be disconnected for servicing other than for the removal of the part that they protect unless the relevant hazard is removed at the same time.

Compliance is checked by inspection.

2.6.5.6 Corrosion resistance

Conductive parts in contact at protective earthing terminals and connections shall not be subject to significant corrosion due to electrochemical action in any working, storage or transport environment conditions as specified in the instructions supplied with the equipment. Combinations above the line in Annex J shall be avoided. Corrosion resistance can be achieved by a suitable plating or coating process.

Compliance is checked by inspection and by reference to the table of electrochemical potentials (Annex J).

2.6.5.7 Screws for protective bonding

NOTE The following requirements are additional to those in 3.1.6.

Self-tapping (thread-cutting and thread-forming) and spaced thread (sheet metal) screws are permitted to provide protective bonding but it shall not be necessary to disturb the connection during servicing.

In any case, the thickness of the metal part at the point where a screw is threaded into it shall be not less than twice the pitch of the screw thread. It is permitted to use local extrusion of a metal part to increase the effective thickness.

At least two screws shall be used for each connection. However, it is permitted to use a single self-tapping screw provided that the thickness of the metal part at the point where the screw is threaded into it is a minimum of 0,9 mm for a screw of the thread-forming type and 1,6 mm for a screw of the thread-cutting type.

Compliance is checked by inspection.

2.6.5.8 Reliance on telecommunication network or cable distribution system

Protective earthing shall not rely on a TELECOMMUNICATION NETWORK or a CABLE DISTRIBUTION SYSTEM.

Compliance is checked by inspection.

2.7 Overcurrent and earth fault protection in primary circuits

2.7.1 Basic requirements

To protect against excessive current, short-circuits and earth faults in PRIMARY CIRCUITS, protective devices shall be included either as integral parts of the equipment or as parts of the building installation, subject to the following, a), b) and c):

- a) except as detailed in b) and c), protective devices necessary to comply with the requirements of 5.3 shall be included as parts of the equipment;
- b) for components in series with the mains input to the equipment such as the supply cord, appliance coupler, r.f.i. filter and switch, short-circuit and earth fault protection may be provided by protective devices in the building installation;
- c) it is permitted for PLUGGABLE EQUIPMENT TYPE B or PERMANENTLY CONNECTED EQUIPMENT, to rely on dedicated overcurrent and short-circuit protection in the building installation, provided that the means of protection, e.g. fuses or circuit breakers, is fully specified in the installation instructions. **C**

Ⓒ If reliance is placed on protection in the building installation, the installation instructions shall so state, except that for PLUGGABLE EQUIPMENT TYPE A the building installation shall be regarded as providing protection in accordance with the rating of the wall socket outlet. Ⓒ

Ⓒ Note deleted Ⓒ

Compliance is checked by inspection.

2.7.1 Ⓒ This subclause has been declared 'void'. Ⓒ

2.7.2 Short-circuit backup protection

Unless appropriate short-circuit backup protection is provided, protective devices shall have adequate breaking (rupturing) capacity to interrupt the maximum fault current (including short-circuit current) which can flow.

For PERMANENTLY CONNECTED EQUIPMENT or PLUGGABLE EQUIPMENT TYPE B, it is permitted for short-circuit backup protection to be in the building installation.

For PLUGGABLE EQUIPMENT TYPE A, the building installation is considered as providing short-circuit backup protection.

NOTE If fuses complying with IEC 60127 are used in PRIMARY CIRCUITS, they should have high breaking capacity (1 500 A) if the prospective short-circuit current exceeds 35 A or ten times the current rating of the fuse, whichever is greater.

Compliance is checked by inspection and by the tests of 5.3.

2.7.3 Number and location of protective devices

Protective systems or devices in PRIMARY CIRCUITS shall be in such a number and located so as to detect and to interrupt the overcurrent flowing in any possible fault current path (for example, line-to-line, line-to-neutral, line to protective earth conductor or line to PROTECTIVE BONDING CONDUCTOR).

No protection is required against earth faults in equipment that either:

- has no connection to earth; or
- has DOUBLE INSULATION or REINFORCED INSULATION between the PRIMARY CIRCUIT and all parts connected to earth.

NOTE 1 Where DOUBLE INSULATION or REINFORCED INSULATION is provided, a short-circuit to earth would be considered to be two faults.

In a supply using more than one line conductor to a load, if a protective device interrupts the neutral conductor, it shall also interrupt all other supply conductors. Single-pole protective devices, therefore, shall not be used in such cases.

Compliance is checked by inspection and, where necessary, by simulation of single fault conditions (see 1.4.14).

NOTE 2 For protective devices that are an integral part of the equipment, examples of the number and location of fuses or circuit-breaker poles necessary to provide fault current interruption in commonly encountered supply systems are given in informative Table 2F for single-phase equipment or subassemblies and in informative Table 2G for three-phase equipment. The examples are not necessarily valid for protective devices external to the equipment.

Table 2F – Informative examples of protective devices in single-phase equipment or subassemblies

| Equipment supply connections | Protection against | Minimum number of fuses or circuit-breaker poles | Location |
|---|--------------------|--|------------------------------|
| Case A: Equipment to be connected to power distribution systems with earthed neutral reliably identified, except for case C below | Earth faults | 1 | Line conductor |
| | Overcurrent | 1 | Either of the two conductors |
| Case B: Equipment to be connected to any supply, including IT power distribution systems and supplies with reversible plugs, except for case C below | Earth faults | 2 | Both conductors |
| | Overcurrent | 1 | Either of the two conductors |
| Case C: Equipment to be connected to three-wire power distribution systems with earthed neutral reliably identified | Earth faults | 2 | Each line conductor |
| | Overcurrent | 2 | Each line conductor |

Table 2G – Informative examples of protective devices in three-phase equipment

| Power distribution system | Number of supply conductors | Protection against | Minimum number of fuses or circuit-breaker poles | Location |
|---------------------------------|-----------------------------|--------------------|--|----------------------|
| Three-phase without neutral | 3 | Earth faults | 3 | All three conductors |
| | | Overcurrent | 2 | Any two conductors |
| With earthed neutral (TN or TT) | 4 | Earth faults | 3 | Each line conductor |
| | | Overcurrent | 3 | Each line conductor |
| With unearthed neutral | 4 | Earth faults | 4 | All four conductors |
| | | Overcurrent | 3 | Each line conductor |

2.7.5 Protection by several devices

Where protective devices are used in more than one pole of a supply to a given load, those devices shall be located together. It is permitted to combine two or more protective devices in one component.

Compliance is checked by inspection.

2.7.6 Warning to service persons

Suitable marking shall be provided on the equipment or a statement shall be provided in the servicing instructions to alert a SERVICE PERSON to a possible hazard, where both of the following conditions exist:

- fuse is used in the neutral of single-phase equipment either permanently connected or provided with a non-reversible plug; and
- after operation of the fuse, parts of the equipment that remain energized might represent a hazard during servicing.

The following or similar wording is regarded as suitable:

**CAUTION
DOUBLE POLE/NEUTRAL FUSING**

As an alternative to the above wording, use of the following combination of representative symbols, which includes the electric shock hazard symbol ISO 3864, No. 5036, the fuse symbol IEC-60417- 5016 (DB:2002-10), and an indication that the fuse is in the neutral N, is permitted. However in this case, the statement shall also be provided in the servicing instructions.



Compliance is checked by inspection.

2.8 Safety interlocks

2.8.1 General principles

SAFETY INTERLOCKS shall be provided where OPERATOR access involves areas normally presenting hazards in the meaning of this standard.

Compliance is checked by inspection.

2.8.2 Protection requirements

SAFETY INTERLOCKS shall be so designed that the hazard will be removed before the covers, doors, etc., are in any position that will permit contact with hazardous parts by the test finger, Figure 2A (see 2.1.1.1).

For protection against electric shock, radiation and energy hazards, removal, opening or withdrawal of the cover, door, etc., shall either:

- necessitate previous de-energization of such parts; or
- automatically initiate disconnection of the supply to such parts, and reduce within 2 s the voltage to 42,4 V peak, or 60 V d.c., or less, and the energy level to less than 20 J.

For a moving part that will continue to move through momentum and will continue to present a mechanical hazard (for example, a spinning print drum), removal, opening or withdrawal of the cover, door, etc., shall either:

- necessitate previous reduction of movement to an acceptable safe level; or
- automatically initiate reduction of the movement to an acceptable safe level.

Compliance is checked by inspection, measurement and use of the test finger, Figure 2A (see 2.1.1.1).

2.8.3 Inadvertent reactivation

SAFETY INTERLOCKS shall be designed so that inadvertent reactivation of the hazard cannot occur when covers, guards, doors, etc., are not in the closed position.

Any accessible SAFETY INTERLOCK that can be operated by means of the test finger, Figure 2A (see 2.1.1.1), is considered to be likely to cause inadvertent reactivation of the hazard.

SAFETY INTERLOCK switches shall be selected taking into account the mechanical shock and vibration experienced in normal operation, so that this does not cause inadvertent switching to an unsafe condition.

Compliance is checked by inspection and, where necessary, by a test with the test finger, Figure 2A (see 2.1.1.1).

2.8.4 Fail-safe operation

A SAFETY INTERLOCK system shall be so designed and constructed that either:

- a failure of the SAFETY INTERLOCK system during the normal life of the equipment is not likely to occur and, even if a failure should occur, it shall not create an extreme hazard; or
- a failure of the SAFETY INTERLOCK system during the normal life of the equipment is possible, the probable failure mode(s) will not create a hazard for which protection is required.

Compliance is checked by inspection of the SAFETY INTERLOCK system, circuit diagrams and available data and, if necessary, by simulation of single faults (see 1.4.14) (for example, failure of a semi-conductor device or an electromechanical component). Moving mechanical parts in mechanical and electromechanical systems are not subjected to simulated single faults if they comply with 2.8.5 and 2.8.7.

It is permitted to use simulated SAFETY INTERLOCK systems for tests.

2.8.5 Moving parts

Moving mechanical parts in mechanical and electromechanical SAFETY INTERLOCK systems shall have adequate endurance.

Compliance is checked by inspection of the SAFETY INTERLOCK system, available data and, if necessary, by cycling the SAFETY INTERLOCK system through 10 000 operating cycles without failure other than in a safe mode.

NOTE The above test is conducted to check the endurance of moving parts other than those in SAFETY INTERLOCK switches and relays. SAFETY INTERLOCK switches and relays, if any, are subject to 2.8.7. If the test of 2.8.7.3 is required in addition to the above test, the tests should be combined.

2.8.6 Overriding

Where it may be necessary for a SERVICE PERSON to override a SAFETY INTERLOCK, the override system shall comply with all of the following:

- require an intentional effort to operate; and
- reset automatically to normal operation when servicing is complete, or prevent normal operation unless the SERVICE PERSON has reset the SAFETY INTERLOCK; and

- require a TOOL for operation when in an OPERATOR ACCESS AREA and not be operable with the test finger, Figure 2A (see 2.1.1.1); and
- not bypass a SAFETY INTERLOCK for an extreme hazard unless another reliable means of safety protection becomes effective when the SAFETY INTERLOCK is thus bypassed. The equipment shall be designed such that the SAFETY INTERLOCK cannot be bypassed until the other means of protection is fully in place and operational.

Compliance is checked by inspection.

2.8.7 Switches and relays

A switch in a SAFETY INTERLOCK system shall:

- conform to IEC 61058-1, with evaluation for 10 000 operating cycles in accordance with 7.1.4.4 of IEC 61058-1; or
- comply with 2.8.7.1 and pass the tests of 2.8.7.3 and 2.8.7.4; or
- pass the tests of 2.8.7.2, 2.8.7.3 and 2.8.7.4.

A relay in a SAFETY INTERLOCK system shall:

- comply with 2.8.7.1 and pass the tests of 2.8.7.3 and 2.8.7.4; or
- pass the tests of 2.8.7.2, 2.8.7.3 and 2.8.7.4.

Compliance is checked by inspection and by the relevant tests of 2.8.7.1 to 2.8.7.4.

2.8.7.1 Contact gaps

If the contact gap is located in the PRIMARY CIRCUIT, the contact gap shall not be less than that for a disconnect device (see 3.4.2). If the contact gap is located in a circuit other than a PRIMARY CIRCUIT, the contact gap shall be not less than the relevant minimum CLEARANCE value for BASIC INSULATION in a SECONDARY CIRCUIT specified in 2.10.3 (or Annex G).

Compliance is checked by inspection of the available data and, if necessary, by measurement.

2.8.7.2 Overload test

The contact of the SAFETY INTERLOCK switch or relay is subjected to an overload test consisting of 50 cycles of operation at the rate of 6 to 10 cycles per minute, making and breaking 150 % of the current imposed in the application, except that where a contact switches a motor load, the test is conducted with the rotor of the motor in a locked condition. After the test, the switch or relay shall still be functional.

2.8.7.3 Endurance test

The contact of the SAFETY INTERLOCK switch or relay is subjected to an endurance test, making and breaking 100 % of the current imposed in the application at a rate of 6 to 10 cycles of operation per minute. A higher rate of cycling is permitted if requested by the manufacturer. For reed switches in ELV CIRCUITS, SELV CIRCUITS and TNV-1 CIRCUITS, the test is 100 000 operating cycles. For other switches and relays, the test is 10 000 operating cycles. After the test, the switch or relay shall still be functional.

2.8.7.4 Electric strength test

Except for reed switches in ELV CIRCUITS, SELV CIRCUITS and TNV-1 CIRCUITS, an electric strength test as specified in 5.2.2, is applied between the contacts after the tests of 2.8.7.2 and 2.8.7.3. If the contact is in a PRIMARY CIRCUIT, the test voltage is as specified for REINFORCED INSULATION. If the contact is in a circuit other than a PRIMARY CIRCUIT, the test voltage is as specified for BASIC INSULATION in a PRIMARY CIRCUIT.

2.8.8 Mechanical actuators

Where the actuating part in a mechanical SAFETY INTERLOCK system is relied upon for safety, precautions shall be taken to ensure that it is not overstressed. If this requirement is not covered by the design of the component, the over-travel beyond the operating position of the actuator shall be limited to 50 % of the maximum, for example, by its mounting or location, or by adjustment.

Compliance is checked by inspection and measurement.

2.9 Electrical insulation

2.9.1 Properties of insulating materials

The choice and application of insulating materials shall take into account the needs for electrical, thermal and mechanical strength, frequency of the WORKING VOLTAGE and the working environment (temperature, pressure, humidity and pollution).

Natural rubber, hygroscopic materials and materials containing asbestos shall not be used as insulation.

Driving belts and couplings shall not be relied upon to ensure electrical insulation, unless the belt or coupling is of a special design that removes the risk of inappropriate replacement.

Compliance is checked by inspection and, where necessary, by evaluation of the data for the material.

Where necessary, if the data does not confirm that the material is non-hygroscopic, the hygroscopic nature of the material is determined by subjecting the component or subassembly employing the insulation in question to the humidity treatment of 2.9.2. The insulation is then subjected to the relevant electric strength test of 5.2.2 while still in the humidity cabinet, or in the room in which the samples were brought to the prescribed temperature.

2.9.2 Humidity conditioning

Where required by 2.9.1, 2.10.8.3, 2.10.10 or 2.10.11, humidity conditioning is conducted for 48 h in a cabinet or room containing air with a relative humidity of 91 % to 95 %. The temperature of the air, at all places where samples can be located, is maintained within 1 °C of any convenient value t between 20 °C and 30 °C such that condensation does not occur. During this conditioning the component or subassembly is not energized.

With the concurrence of the manufacturer, it is permitted to increase the 48 h time duration.

Before the humidity conditioning the sample is brought to a temperature between t and $t + 4$ °C.

2.9.3 Grade of insulation

Insulation shall be considered to be FUNCTIONAL INSULATION, BASIC INSULATION, SUPPLEMENTARY INSULATION, REINFORCED INSULATION OR DOUBLE INSULATION.

The application of insulation in many common situations is described in Table 2H and illustrated in Figure 2H, but other situations and solutions are possible. These examples are informative; in some cases the necessary grade of insulation may be higher or lower. Where a different grade may be necessary, or if a particular configuration of energized parts is not represented in the examples, the necessary grade of insulation should be determined by considering the effect of a single fault (see 1.4.14). This should leave the requirements for protection against electric shock intact.

In certain cases, insulation may be bridged by a conductive path (for example, where 1.5.6, 1.5.7, 2.2.4, 2.3.4 or 2.4.3 applies) provided that the level of safety is maintained.

For DOUBLE INSULATION it is permitted to interchange the BASIC INSULATION and SUPPLEMENTARY INSULATION elements. Where DOUBLE INSULATION is used, ELV CIRCUITS or unearthed conductive parts are permitted between the BASIC INSULATION and the SUPPLEMENTARY INSULATION provided that the overall level of insulation is maintained.

A BOUNDING SURFACE is treated as an unearthed SELV CIRCUIT if it is part of either:

- an unearthed conductive ENCLOSURE; or
- a non-conductive ENCLOSURE.

Compliance is checked by inspection.

Table 2H – Examples of application of insulation

| Grade of insulation | Location of insulation | | Key to Figure 2H |
|-------------------------|--|---|--|
| | between | and | |
| FUNCTIONAL ^a | unearthed SELV CIRCUIT or double-insulated conductive part | <ul style="list-style-type: none"> - earthed conductive part - double-insulated conductive part - unearthed SELV CIRCUIT - earthed SELV CIRCUIT - earthed TNV-1 CIRCUIT | F1 F2 F2 F1 F10 ^f |
| | earthed SELV CIRCUIT | <ul style="list-style-type: none"> - earthed SELV CIRCUIT - earthed conductive part - unearthed TNV-1 CIRCUIT - earthed TNV-1 CIRCUIT | F11 F11 F12 ^f F13 ^f |
| | ELV CIRCUIT or basic-insulated conductive part | <ul style="list-style-type: none"> - earthed conductive part - earthed SELV CIRCUIT - basic-insulated conductive part - ELV CIRCUIT | F3 F3 F4 F4 |
| | earthed HAZARDOUS VOLTAGE SECONDARY CIRCUIT | earthed HAZARDOUS VOLTAGE SECONDARY CIRCUIT | F5 |
| | TNV-1 CIRCUIT | TNV-1 CIRCUIT | F7 |
| | TNV-2 CIRCUIT | TNV-2 CIRCUIT | F8 |
| | TNV-3 CIRCUIT | TNV-3 CIRCUIT | F9 |
| | series-parallel sections of a transformer winding | | F6 |
| BASIC | PRIMARY CIRCUIT | <ul style="list-style-type: none"> - earthed or unearthed HAZARDOUS VOLTAGE SECONDARY CIRCUIT - earthed conductive part - earthed SELV CIRCUIT - basic-insulated conductive part - ELV CIRCUIT | B1 B2 B2 B3 B3 |
| | earthed or unearthed HAZARDOUS VOLTAGE SECONDARY CIRCUIT | <ul style="list-style-type: none"> - unearthed HAZARDOUS VOLTAGE SECONDARY CIRCUIT - earthed conductive part - earthed SELV CIRCUIT - basic-insulated conductive part - ELV CIRCUIT | B4 B5 B5 B6 B6 |
| | unearthed SELV CIRCUIT or double-insulated conductive part | <ul style="list-style-type: none"> - unearthed TNV-1 CIRCUIT - TNV-2 CIRCUIT - TNV-3 CIRCUIT | B7 ^f B8 ^d B9 ^{d e} |
| | earthed SELV CIRCUIT | <ul style="list-style-type: none"> - TNV-2 CIRCUIT - TNV-3 CIRCUIT | B10 ^d B11 ^{d e} |
| | TNV-2 CIRCUIT | <ul style="list-style-type: none"> - unearthed TNV-1 CIRCUIT - earthed TNV-1 CIRCUIT - TNV-3 CIRCUIT | B12 ^{d e} B13 ^{d e f} B14 ^f |
| | TNV-3 CIRCUIT | <ul style="list-style-type: none"> - unearthed TNV-1 CIRCUIT - earthed TNV-1 CIRCUIT | B12 B13 ^d |
| | SUPPLEMENTARY | basic-insulated conductive part or ELV CIRCUIT | <ul style="list-style-type: none"> - double-insulated conductive part - unearthed SELV CIRCUIT |
| TNV CIRCUIT | | <ul style="list-style-type: none"> - basic-insulated conductive part - ELV CIRCUIT | S2 ^d S2 |

Table 2H (concluded)

| Grade of insulation | Location of insulation | | Key to Figure 2H |
|---|---|---|---|
| | between | and | |
| SUPPLEMENTARY OR REINFORCED | unearthed HAZARDOUS VOLTAGE SECONDARY CIRCUIT | <ul style="list-style-type: none"> - double-insulated conductive part - unearthed SELV CIRCUIT - TNV CIRCUIT | S/R1 ^c S/R1 ^c S/R2 ^c |
| REINFORCED | PRIMARY CIRCUIT | <ul style="list-style-type: none"> - double-insulated conductive part - unearthed SELV CIRCUIT - TNV CIRCUIT | R1 R1 R2 |
| | earthed HAZARDOUS VOLTAGE SECONDARY CIRCUIT | <ul style="list-style-type: none"> - double-insulated conductive part - unearthed SELV CIRCUIT - TNV CIRCUIT | R3 R3 R4 |
| <p>The term "conductive part" refers to an electrically conductive part that is</p> <ul style="list-style-type: none"> - not normally energized, and - not connected to any of the following: <ul style="list-style-type: none"> • a circuit at HAZARDOUS VOLTAGE, or • an ELV CIRCUIT, or • a TNV CIRCUIT, or • an SELV CIRCUIT, or • a LIMITED CURRENT CIRCUIT. <p>Examples of such a conductive part are the BODY of equipment, a transformer core, and in some cases a conductive screen in a transformer.</p> <p>If such a conductive part is protected from a part at HAZARDOUS VOLTAGE by:</p> <ul style="list-style-type: none"> - DOUBLE INSULATION or REINFORCED INSULATION, it is termed a "double-insulated conductive part"; - BASIC INSULATION plus protective earthing, it is termed an "earthed conductive part"; - BASIC INSULATION but is not earthed, that is it has no second level of protection, it is termed a "basic-insulated conductive part". <p>A circuit or conductive part is termed "earthed" if it is connected to a protective earthing terminal or contact in such a way as to meet the requirements in 2.6 (although it will not necessarily be at earth potential). Otherwise the circuit or conductive part is termed "unearthed".</p> | | | |
| <p>^a For requirements for FUNCTIONAL INSULATION, see 5.3.4.</p> <p>^b The WORKING VOLTAGE of the SUPPLEMENTARY INSULATION between an ELV CIRCUIT or a basic-insulated conductive part and an unearthed accessible conductive part is equal to the most onerous WORKING VOLTAGE for the BASIC INSULATION. The most onerous WORKING VOLTAGE may be due to a PRIMARY CIRCUIT or SECONDARY CIRCUIT and the insulation is specified accordingly.</p> <p>^c Insulation between an unearthed SECONDARY CIRCUIT at HAZARDOUS VOLTAGE and an unearthed accessible conductive part or circuit (S/R, S/R1 or S/R2 in Figure 2H) shall satisfy the more onerous of the following:</p> <ul style="list-style-type: none"> - REINFORCED INSULATION whose WORKING VOLTAGE is equal to the HAZARDOUS VOLTAGE; or - SUPPLEMENTARY INSULATION whose WORKING VOLTAGE is equal to the voltage between the SECONDARY CIRCUIT at HAZARDOUS VOLTAGE and <ul style="list-style-type: none"> • another SECONDARY CIRCUIT at HAZARDOUS VOLTAGE, or • a PRIMARY CIRCUIT. <p>These examples apply if:</p> <ul style="list-style-type: none"> - there is only BASIC INSULATION between the SECONDARY CIRCUIT and the PRIMARY CIRCUIT; and - there is only BASIC INSULATION between the SECONDARY CIRCUIT and earth. <p>^d BASIC INSULATION is not always required (see 2.3.2.1 and 2.10.5.13).</p> <p>^e The requirements of 2.10 apply, see also 6.2.1.</p> <p>^f The requirements of 2.10 do not apply, however see 6.2.1.</p> | | | |

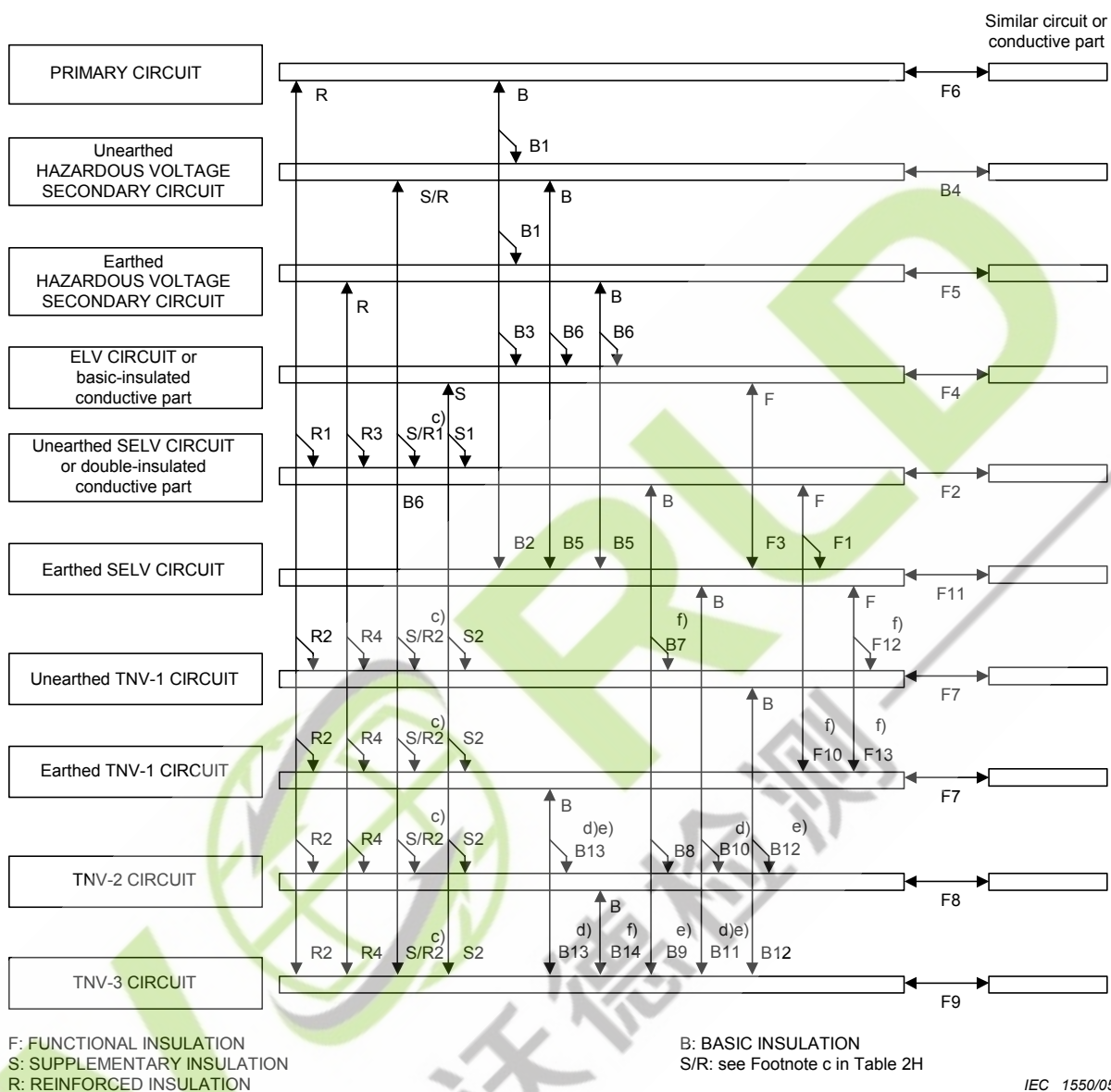

NOTE The references c), d), e) and f) refer to the corresponding footnotes in Table 2H.

Figure 2H – Examples of application of insulation

2.9.4 Separation from hazardous voltages

Where accessible conductive parts, including SELV CIRCUITS, TNV CIRCUITS and their related windings, are separated from parts at HAZARDOUS VOLTAGE, the following constructions are permitted. The insulation, including each element of DOUBLE INSULATION, shall be rated for the WORKING VOLTAGE, or if applicable the REQUIRED WITHSTAND VOLTAGE, between the parts. The different methods of separation fall into three groups, methods 1, 2 and 3.

- a) (Method 1) DOUBLE INSULATION or REINFORCED INSULATION providing permanent separation, assured by barriers, routing or fixing; or
- b) (Method 1) DOUBLE INSULATION or REINFORCED INSULATION on or between the parts to be separated; or

- c) (Method 1) DOUBLE INSULATION, consisting of BASIC INSULATION on one of the parts to be separated and SUPPLEMENTARY INSULATION on the other part; or
- d) (Method 2) BASIC INSULATION on the part at a HAZARDOUS VOLTAGE, together with protective screening connected to the main protective earthing terminal in accordance with 2.6.1 b); or
- e) (Method 3) BASIC INSULATION on the part at a HAZARDOUS VOLTAGE, together with connection of the other part to the main protective earthing terminal in accordance with 2.6.1 b), such that the voltage limits for the accessible part are maintained by relative circuit impedances or by the operation of a protective device; or
- f) any other construction providing equivalent separation.

NOTE 1 For examples of other constructions providing equivalent separation, see Table 2H and Figure 2H.

For e), it is permitted to protect a circuit by earthing a part other than the protected circuit itself, for example, the secondary winding of a transformer supplying the protected circuit.

NOTE 2 The consequences of the circuit possibly being earthed at a second point, for example, by connection to other equipment, should be considered.

Compliance is checked by inspection.

2.10 Clearances, creepage distances and distances through insulation

2.10.1 General

In general, compliance with 2.10.1 is checked by inspection and, when necessary, by measurement.

2.10.1.1 Frequency

The insulation requirements given in 2.10 are for frequencies up to 30 kHz. It is permitted to use the same requirements for insulation operating at frequencies over 30 kHz until additional data is available.

NOTE For information on insulation behaviour in relation to frequency see IEC 60664-1 and IEC 60664-4.

2.10.1.2 Pollution degrees

Pollution degrees are classified as follows:

- Pollution Degree 1 applies where there is no pollution or only dry, non-conductive pollution. The pollution has no influence. Normally, this is achieved by having components and subassemblies adequately enclosed by enveloping or hermetic sealing so as to exclude dust and moisture (see 2.10.12).
- Pollution Degree 2 applies where there is only non-conductive pollution that might temporarily become conductive due to occasional condensation. It is generally appropriate for equipment covered by the scope of this standard.
- Pollution Degree 3 applies where a local environment within the equipment is subject to conductive pollution, or to dry non-conductive pollution that could become conductive due to expected condensation.

2.10.1.3 Reduced values for functional insulation

There is no minimum CLEARANCE or CREEPAGE DISTANCE for FUNCTIONAL INSULATION unless it is required by 5.3.4 a).

NOTE If CLEARANCES and CREEPAGE DISTANCES for FUNCTIONAL INSULATION are smaller than those specified in 2.10.3, 2.10.4 and Annex G, they are subject to the requirements of 5.3.4 b) or 5.3.4 c).

2.10.1.4 Intervening unconnected conductive parts

It is permitted for CLEARANCES and CREEPAGE DISTANCES to be divided by intervening, unconnected (floating) conductive parts, such as unused contacts of a connector, provided that the sum of the individual distances meets the specified minimum requirements, see Table F.1 and Figure F.13.

2.10.1.5 Insulation with varying dimensions

If the insulation of a transformer has different WORKING VOLTAGES along the length of the winding, it is permitted to vary CLEARANCES, CREEPAGE DISTANCES and distances through insulation accordingly.

NOTE An example of such a construction is a 30 kV winding, consisting of multiple bobbins connected in series, and earthed at one end.

2.10.1.6 Special separation requirements

The requirements of 2.10 and Annex G do not apply to separation provided to comply with 2.3.2 unless BASIC INSULATION is used, nor to separation provided to comply with 6.1.2 or 6.2.1.

NOTE See also Footnote f of Table 2H.

2.10.1.7 Insulation in circuits generating starting pulses

For a circuit generating starting pulses to ignite a discharge lamp, and if the circuit is a LIMITED CURRENT CIRCUIT complying with 2.4, the requirements for FUNCTIONAL INSULATION apply between the circuit and other conductive parts (see 5.3.4).

If the circuit is not a LIMITED CURRENT CIRCUIT, the requirements for BASIC INSULATION, SUPPLEMENTARY INSULATION and REINFORCED INSULATION apply to CREEPAGE DISTANCES and distances through insulation. For CLEARANCES, see 2.10.3.5.

NOTE For WORKING VOLTAGES in the above cases, see 2.10.2.1 i).

2.10.2 Determination of working voltage

In general, compliance with 2.10.2 is checked by inspection and, when necessary, by measurement.

2.10.2.1 General

In determining WORKING VOLTAGES, all of the following requirements apply (see also 1.4.8).

- a) Unearthed accessible conductive parts shall be assumed to be earthed.
- b) If a transformer winding or other part is floating (it is not connected to a circuit that establishes its potential relative to earth), it shall be assumed to be earthed at the point by which the highest WORKING VOLTAGE is obtained.

- c) Except as permitted in 2.10.1.5, for insulation between two transformer windings, the highest voltage between any two points in the two windings shall be used, taking into account external voltages to which the windings will be connected.
- d) Except as permitted in 2.10.1.5, for insulation between a transformer winding and another part, the highest voltage between any point on the winding and the other part shall be used.
- e) Where DOUBLE INSULATION is used, the WORKING VOLTAGE across the BASIC INSULATION shall be determined by imagining a short-circuit across the SUPPLEMENTARY INSULATION, and vice versa. For DOUBLE INSULATION between transformer windings, the short-circuit shall be assumed to take place at the point by which the highest WORKING VOLTAGE is produced in the other insulation.
- f) When the WORKING VOLTAGE is determined by measurement, the input power supplied to the EUT shall be at the RATED VOLTAGE or the voltage within the RATED VOLTAGE RANGE that results in the highest measured value.

NOTE Tolerances on the RATED VOLTAGE or RATED VOLTAGE RANGE are not taken into account.

- g) The WORKING VOLTAGE between any point in the PRIMARY CIRCUIT and earth, and between any point in the PRIMARY CIRCUIT and a SECONDARY CIRCUIT, shall be assumed to be the greater of the following:
 - the RATED VOLTAGE or the upper voltage of the RATED VOLTAGE RANGE; and
 - the measured voltage.
- h) When determining the WORKING VOLTAGE for a TNV CIRCUIT connected to a TELECOMMUNICATION NETWORK, the normal operating voltages shall be taken into account. If these are not known, they shall be assumed to be the following values:
 - 60 V d.c. for TNV-1 CIRCUITS;
 - 120 V d.c. for TNV-2 CIRCUITS and TNV-3 CIRCUITS.Telephone ringing signals shall not be taken into account for this purpose.
- i) If starting pulses are used to ignite discharge lamps, the PEAK WORKING VOLTAGE is the peak value of the pulses with the lamp connected but before the lamp ignites. The RMS WORKING VOLTAGE to determine minimum CREEPAGE DISTANCES is the voltage measured after the ignition of the lamp.

2.10.2.2 RMS working voltage

Minimum CREEPAGE DISTANCES depend on RMS WORKING VOLTAGES.

When determining an RMS WORKING VOLTAGE, the following rules shall be used:

- the measured r.m.s. value shall be used for all waveforms;
- short-term conditions (for example, cadenced telephone ringing signals in TNV CIRCUITS) shall not be taken into account;
- non-repetitive transients (due, for example, to atmospheric disturbances) shall not be taken into account.

NOTE The resultant r.m.s. value of a waveform having an a.c. r.m.s. voltage "A" and a d.c. offset voltage "B" is given by the following formula:

$$\text{r.m.s. value} = (A^2 + B^2)^{1/2}$$

2.10.2.3 Peak working voltage

Minimum CLEARANCES and electric strength test voltages depend on PEAK WORKING VOLTAGES.

When determining a PEAK WORKING VOLTAGE, the following rules shall be used:

- the measured peak value shall be used for all waveforms; the peak value of any ripple (up to 10 %) on a DC VOLTAGE, shall be included;
- non-repetitive transients (due, for example, to atmospheric disturbances) shall not be taken into account;
- when determining the PEAK WORKING VOLTAGE between PRIMARY CIRCUITS and SECONDARY CIRCUITS, the voltage of any ELV CIRCUIT, SELV CIRCUIT or TNV CIRCUIT (including telephone ringing signals) shall be regarded as zero.

2.10.3 Clearances

2.10.3.1 General

CLEARANCES shall be so dimensioned that overvoltages, including transients that may enter the equipment, and peak voltages that may be generated within the equipment, do not break down the CLEARANCE.

It is permitted to use either the requirements of 2.10.3 for Overvoltage Category I or Overvoltage Category II, using the PEAK WORKING VOLTAGE; or the requirements in Annex G for Overvoltage Category I, Overvoltage Category II, Overvoltage Category III or Overvoltage Category IV, using the REQUIRED WITHSTAND VOLTAGE, for a particular component or subassembly or for the whole equipment.

These requirements apply for equipment to be operated up to 2 000 m above sea level. For equipment to be operated at more than 2 000 m above sea level, the minimum CLEARANCES shall be multiplied by the factor given in Table A.2 of IEC 60664-1. Linear interpolation is permitted between the nearest two points in Table A.2. The calculated minimum CLEARANCE using this multiplication factor shall be rounded up to the next higher 0,1 mm increment.

NOTE 1 It is considered to be good practice to design SOLID INSULATION for higher transient overvoltages than the associated CLEARANCE.

The specified minimum CLEARANCES are subject to the following minimum values:

- 10 mm for an air gap serving as REINFORCED INSULATION between a part at HAZARDOUS VOLTAGE and an accessible conductive part of the ENCLOSURE of floor-standing equipment or of the non-vertical top surface of desk top equipment;
- 2 mm for an air gap serving as BASIC INSULATION between a part at HAZARDOUS VOLTAGE and an earthed accessible conductive part of the ENCLOSURE of PLUGGABLE EQUIPMENT TYPE A.

NOTE 2 The above two minimum CLEARANCES do not apply between a part at a HAZARDOUS VOLTAGE and the BOUNDING SURFACE of a non-conductive ENCLOSURE.

Except as required by 2.8.7.1 the specified minimum CLEARANCES do not apply to the air gap between the contacts of THERMOSTATS, THERMAL CUT-OUTS, overload protection devices, switches of microgap construction, and similar components where the air gap varies with the contacts.

NOTE 3 For air gaps between contacts of interlock switches, see 2.8.7.1. For air gaps between contacts of disconnect switches, see 3.4.2.

The CLEARANCES between the BOUNDING SURFACE of a connector and conductive parts within the connector that are connected to a HAZARDOUS VOLTAGE shall comply with the requirements for REINFORCED INSULATION. As an exception, for connectors that are

- fixed to the equipment; and
- located internal to the outer ENCLOSURE of the equipment; and are
- only accessible after removal of a USER-replaceable subassembly that is required to be in place during normal operation,

these CLEARANCES shall comply with the requirements for BASIC INSULATION.

NOTE 4 The tests of 2.1.1.1 for access to hazardous parts apply to such connectors after removal of the subassembly.

For all other CLEARANCES in connectors, including connectors that are not fixed to the equipment, the minimum values specified in 2.10.3.3 or 2.10.3.4 apply.

The above minimum CLEARANCES for connectors do not apply to connectors that comply with a standard harmonized with IEC 60083, IEC 60309, IEC 60320, IEC 60906-1 or IEC 60906-2, see also 1.5.2.

Compliance with 2.10.3.3 and 2.10.3.4 is checked by measurement, taking into account Annex F. The following conditions apply:

- *movable parts shall be placed in the most unfavourable position;*
- *for equipment incorporating ordinary NON-DETACHABLE POWER SUPPLY CORDS, CLEARANCE measurements are made with supply conductors of the largest cross-sectional area specified in 3.3.4, and also without conductors.*

NOTE 5 The force tests of 4.2.2, 4.2.3 and 4.2.4 apply.

- *when measuring CLEARANCES from the BOUNDING SURFACE of an ENCLOSURE of insulating material through a slot or opening in the ENCLOSURE or through an opening in an accessible connector, the accessible surface shall be considered to be conductive as if it were covered by metal foil wherever it can be touched by the test finger shown in Figure 2A (see 2.1.1.1), applied without appreciable force (see Figure F.12, point X).*

There is no electric strength test to verify CLEARANCES except as required in Footnote c in Table 2M and in 5.3.4 b).

2.10.3.2 Mains transient voltages

a) AC MAINS SUPPLY

For equipment to be supplied from an AC MAINS SUPPLY, the value of the MAINS TRANSIENT VOLTAGE depends on the Overvoltage Category and the AC MAINS SUPPLY voltage. In general, CLEARANCES in equipment intended to be connected to the AC MAINS SUPPLY shall be designed for Overvoltage Category II.

NOTE 1 See Annex Z for further guidance on the determination of Overvoltage Category.

Equipment that is likely, when installed, to be subjected to transient overvoltages that exceed those for its design Overvoltage Category will require additional protection to be provided external to the equipment. In this case, the installation instructions shall state the need for such external protection.

The applicable value of the MAINS TRANSIENT VOLTAGE shall be determined from the Overvoltage Category and the AC MAINS SUPPLY voltage, using Table 2J.

Table 2J – AC mains transient voltages

| AC MAINS SUPPLY voltage ^a up to and including | MAINS TRANSIENT VOLTAGE ^b | |
|---|--------------------------------------|-------|
| | V peak | |
| | Overvoltage Category | |
| V r.m.s. | I | II |
| 50 | 330 | 500 |
| 100 | 500 | 800 |
| 150 ^c | 800 | 1 500 |
| 300 ^d | 1 500 | 2 500 |
| 600 ^e | 2 500 | 4 000 |

^a For equipment designed to be connected to a three-phase, three-wire supply, where there is no neutral conductor, the AC MAINS SUPPLY voltage is the line-to-line voltage. In all other cases, where there is a neutral conductor, it is the line-to-neutral voltage.

^b The MAINS TRANSIENT VOLTAGE is always one of the values in the table. Interpolation is not permitted.

^c Including 120/208 V and 120/240 V.

^d Including 230/400 V and 277/480 V.

^e Including 400/690 V.

Ⓢ Note deleted Ⓢ

b) Earthed DC MAINS SUPPLIES

If a DC MAINS SUPPLY is connected to protective earth and is entirely within a single building, the MAINS TRANSIENT VOLTAGE shall be assumed to be 71 V peak. If this connection is within the EUT, it shall be in accordance with 2.6.1 d).

NOTE 3 The connection to protective earth can be at the source of the DC MAINS SUPPLY or at the equipment location, or both (see ITU-T Recommendation K.27).

c) Unearthed DC MAINS SUPPLIES

If a DC MAINS SUPPLY is not earthed and located as in b) above, the MAINS TRANSIENT VOLTAGE shall be assumed to be equal to the MAINS TRANSIENT VOLTAGE in the AC MAINS SUPPLY from which the DC MAINS SUPPLY is derived.

d) Battery operation

If equipment is supplied from a dedicated battery that has no provision for charging from an external MAINS SUPPLY, the MAINS TRANSIENT VOLTAGE shall be assumed to be 71 V peak.

2.10.3.3 Clearances in primary circuits

For insulation in PRIMARY CIRCUITS, between PRIMARY CIRCUITS and earth and between PRIMARY CIRCUITS and SECONDARY CIRCUITS, the following rules apply.

For an AC MAINS SUPPLY not exceeding 300 V r.m.s. (420 V peak):

- a) if the PEAK WORKING VOLTAGE does not exceed the peak value of the AC MAINS SUPPLY voltage, minimum CLEARANCES are determined from Table 2K;
- b) if the PEAK WORKING VOLTAGE exceeds the peak value of the AC MAINS SUPPLY voltage, the minimum CLEARANCE is the sum of the following two values:
 - the minimum CLEARANCE from Table 2K; and
 - the appropriate additional CLEARANCE from Table 2L.

NOTE A minimum CLEARANCE obtained by the use of Table 2L lies between the values required for homogeneous and inhomogeneous fields. As a result, it may not pass the appropriate electric strength test if the field is substantially inhomogeneous.

For an AC MAINS SUPPLY exceeding 300 V r.m.s. (420 V peak), minimum CLEARANCES are determined from Table 2K.

Table 2K – Minimum clearances for insulation in primary circuits and between primary and secondary circuits

CLEARANCES in mm

| PEAK WORKING VOLTAGE ^a up to and including V | MAINS TRANSIENT VOLTAGE | | | | | | | | | | | | | | |
|---|---------------------------------|--------------|--------------|-----|--------------|----------------------|----------------------|--------------|--------------|-----|----------------------|--------------|-------------------------|--------------|--------------|
| | 1 500 V ^c | | | | | 2 500 V ^c | | | | | 4 000 V ^c | | | | |
| | Pollution degree | | | | | | | | | | | | | | |
| | 1 and 2 ^b | | | 3 | | | 1 and 2 ^b | | | 3 | | | 1, 2 ^b and 3 | | |
| | F | B/S | R | F | B/S | R | F | B/S | R | F | B/S | R | F | B/S | R |
| 71 | 0,4 | 1,0 (0,5) | 2,0 (1,0) | 0,8 | 1,3 (0,8) | 2,6 (1,6) | 1,0 | 2,0 (1,5) | 4,0 (3,0) | 1,3 | 2,0 (1,5) | 4,0 (3,0) | 2,0 | 3,2 (3,0) | 6,4 (6,0) |
| 210 | 0,5 | 1,0 (0,5) | 2,0 (1,0) | 0,8 | 1,3 (0,8) | 2,6 (1,6) | 1,4 | 2,0 (1,5) | 4,0 (3,0) | 1,5 | 2,0 (1,5) | 4,0 (3,0) | 2,0 | 3,2 (3,0) | 6,4 (6,0) |
| 420 | F 1,5 B/S 2,0 (1,5) R 4,0 (3,0) | | | | | | | | | | | 2,5 | 3,2 (3,0) | 6,4 (6,0) | |
| 840 | F 3,0 B/S 3,2 (3,0) R 6,4 (6,0) | | | | | | | | | | | | | | |
| 1 400 | F/B/S 4,2 R 6,4 | | | | | | | | | | | | | | |
| 2 800 | F/B/S/R 8,4 | | | | | | | | | | | | | | |
| 7 000 | F/B/S/R 17,5 | | | | | | | | | | | | | | |
| 9 800 | F/B/S/R 25 | | | | | | | | | | | | | | |
| 14 000 | F/B/S/R 37 | | | | | | | | | | | | | | |
| 28 000 | F/B/S/R 80 | | | | | | | | | | | | | | |
| 42 000 | F/B/S/R 130 | | | | | | | | | | | | | | |

The values in the table are applicable to FUNCTIONAL INSULATION (F) if required by 5.3.4 a) (see 2.10.1.3), BASIC INSULATION (B), SUPPLEMENTARY INSULATION (S) and REINFORCED INSULATION (R).

The values in parentheses apply to BASIC INSULATION, SUPPLEMENTARY INSULATION or REINFORCED INSULATION only if manufacturing is subjected to a quality control programme that provides at least the same level of assurance as the example given in Clause R.2. DOUBLE INSULATION and REINFORCED INSULATION shall be subjected to ROUTINE TESTS for electric strength.

If the PEAK WORKING VOLTAGE exceeds the peak value of the AC MAINS SUPPLY voltage, linear interpolation is permitted between the nearest two points, the calculated minimum CLEARANCE being rounded up to the next higher 0,1 mm increment.

^a If the PEAK WORKING VOLTAGE exceeds the peak value of the AC MAINS SUPPLY voltage, see 2.10.3.3 b) regarding additional CLEARANCES.

^b It is not required to pass the tests of 2.10.10 for Pollution Degree 1.

^c The relationship between MAINS TRANSIENT VOLTAGE and AC MAINS SUPPLY voltage is given in Table 2J.

Table 2L – Additional clearances in primary circuits

CLEARANCES in mm

| MAINS TRANSIENT VOLTAGE | | | | | | |
|--|--------------------|---|-----------------------|--|---|-----------------------|
| 1 500 V ^c | | | | 2 500 V ^c | | |
| Pollution Degrees 1 and 2 ^b | Pollution Degree 3 | FUNCTIONAL ^a BASIC OR SUPPLEMENTARY INSULATION | REINFORCED INSULATION | Pollution Degrees 1, 2 and 3 ^b | FUNCTIONAL ^a BASIC OR SUPPLEMENTARY INSULATION | REINFORCED INSULATION |
| PEAK WORKING VOLTAGE up to and including V | | | | PEAK WORKING VOLTAGE up to and including V | | |
| 210 (210) | 210 (210) | 0,0 | 0,0 | 420 (420) | 0,0 | 0,0 |
| 298 (288) | 294 (293) | 0,1 | 0,2 | 493 (497) | 0,1 | 0,2 |
| 386 (366) | 379 (376) | 0,2 | 0,4 | 567 (575) | 0,2 | 0,4 |
| 474 (444) | 463 (459) | 0,3 | 0,6 | 640 (652) | 0,3 | 0,6 |
| 562 (522) | 547 (541) | 0,4 | 0,8 | 713 (729) | 0,4 | 0,8 |
| 650 (600) | 632 (624) | 0,5 | 1,0 | 787 (807) | 0,5 | 1,0 |
| 738 (678) | 715 (707) | 0,6 | 1,2 | 860 (884) | 0,6 | 1,2 |
| 826 (756) | 800 (790) | 0,7 | 1,4 | 933 (961) | 0,7 | 1,4 |
| 914 (839) | | 0,8 | 1,6 | 1 006 (1 039) | 0,8 | 1,6 |
| 1 002 (912) | | 0,9 | 1,8 | 1 080 (1 116) | 0,9 | 1,8 |
| 1 090 (990) | | 1,0 | 2,0 | 1 153 (1 193) | 1,0 | 2,0 |
| | | 1,1 | 2,2 | 1 226 (1 271) | 1,1 | 2,2 |
| | | 1,2 | 2,4 | 1 300 (1 348) | 1,2 | 2,4 |
| | | 1,3 | 2,6 | (1 425) | 1,3 | 2,6 |

The additional CLEARANCES in the table apply if required by 2.10.3.3 b).
 The values in parentheses shall be used:
 - if the values in parentheses in Table 2K are used; and
 - for FUNCTIONAL INSULATION if required by 5.3.4 a).
 For voltage values above the PEAK WORKING VOLTAGE values given in the table, linear extrapolation is permitted.

^a There is no minimum CLEARANCE for FUNCTIONAL INSULATION unless it is required by 5.3.4 a). See 2.10.1.3.
^b It is not required to pass the tests of 2.10.10 for Pollution Degree 1.
^c The relationship between MAINS TRANSIENT VOLTAGE and AC MAINS SUPPLY voltage is given in Table 2J.

2.10.3.4 Clearances in secondary circuits

Minimum CLEARANCES in SECONDARY CIRCUITS are determined from Table 2M.

The PEAK WORKING VOLTAGE for use in Table 2M is:

- the peak value of a sinusoidal voltage;
- the measured peak value of a non-sinusoidal voltage.

The highest transient overvoltage for use in Table 2M is either

- the highest transient from the MAINS SUPPLY, determined in accordance with 2.10.3.6 or 2.10.3.7; or
- the highest transient from a TELECOMMUNICATION NETWORK, determined in accordance with 2.10.3.8,

whichever is the higher value.

Table 2M – Minimum clearances in secondary circuits

CLEARANCES in mm

| PEAK WORKING VOLTAGE up to and including | Highest transient overvoltage in the SECONDARY CIRCUIT (V peak) | | | | | | | | | | | | | | | | | |
|---|---|-------|-----|-------------------------------------|-------|-----|---------------------------|-------|-----|--|-------|-----|---|-------|-----|-------------------------|-------|-------|
| | Up to and including 71 V | | | Over 71 V up to and including 800 V | | | Up to and including 800 V | | | Over 800 V up to and including 1 500 V | | | Over 1 500 V up to and including 2 500 V ^a | | | | | |
| | Pollution Degree | | | | | | | | | | | | | | | | | |
| | 1 and 2 ^b | | | | | | 3 | | | 1 and 2 ^b | | | 3 | | | 1, 2 ^b and 3 | | |
| V | F | B/S | R | F | B/S | R | F | B/S | R | F | B/S | R | F | B/S | R | F | B/S | R |
| 71 | 0,2 | 0,4 | 0,8 | 0,2 | 0,7 | 1,4 | 0,8 | 1,3 | 2,6 | 0,5 | 1,0 | 2,0 | 0,8 | 1,3 | 2,6 | 1,5 | 2,0 | 4,0 |
| | (0,2) | (0,4) | | (0,2) | (0,4) | | (0,8) | (1,6) | | (0,5) | (1,0) | | (0,8) | (1,6) | | (1,5) | (3,0) | |
| 140 | 0,2 | 0,7 | 1,4 | 0,2 | 0,7 | 1,4 | 0,8 | 1,3 | 2,6 | 0,5 | 1,0 | 2,0 | 0,8 | 1,3 | 2,6 | 1,5 | 2,0 | 4,0 |
| | (0,2) | (0,4) | | (0,2) | (0,4) | | (0,8) | (1,6) | | (0,5) | (1,0) | | (0,8) | (1,6) | | (1,5) | (3,0) | |
| 210 | 0,2 | 0,7 | 1,4 | 0,2 | 0,9 | 1,8 | 0,8 | 1,3 | 2,6 | 0,5 | 1,0 | 2,0 | 0,8 | 1,3 | 2,6 | 1,5 | 2,0 | 4,0 |
| | (0,2) | (0,4) | | (0,2) | (0,4) | | (0,8) | (1,6) | | (0,5) | (1,0) | | (0,8) | (1,6) | | (1,5) | (3,0) | |
| 280 | 0,2 | 1,1 | 2,2 | F 0,8 B/S 1,4 (0,8) R 2,8 (1,6) | | | | | | | | | | | | 2,0 | 4,0 | |
| | (0,2) | (0,4) | | | | | | | | | | | | | | 1,5 | (1,5) | (3,0) |
| 420 | 0,2 | 1,4 | 2,8 | F 1,0 B/S 1,9 (1,0) R 3,8 (2,0) | | | | | | | | | | | | 2,0 | 4,0 | |
| | (0,2) | (0,4) | | | | | | | | | | | | | | 1,5 | (1,5) | (3,0) |
| 700 | | | | | | | F/B/S 2,5 | | | R 5,0 | | | | | | | | |
| 840 | | | | | | | F/B/S 3,2 | | | R 5,0 | | | | | | | | |
| 1 400 | | | | | | | F/B/S 4,2 | | | R 5,0 | | | | | | | | |
| 2 800 | | | | | | | F/B/S/R 8,4 | | | See ^c | | | | | | | | |
| 7 000 | | | | | | | F/B/S/R 7,5 | | | See ^c | | | | | | | | |
| 9 800 | | | | | | | F/B/S/R 25 | | | See ^c | | | | | | | | |
| 14 000 | | | | | | | F/B/S/R 37 | | | See ^c | | | | | | | | |
| 28 000 | | | | | | | F/B/S/R 80 | | | See ^c | | | | | | | | |
| 42 000 | | | | | | | F/B/S/R 130 | | | See ^c | | | | | | | | |
| <p>The values in the table apply to FUNCTIONAL INSULATION (F) if required by 5.3.4 a) (see 2.10.1.3), BASIC INSULATION (B), SUPPLEMENTARY INSULATION (S) and REINFORCED INSULATION (R).</p> <p>Linear interpolation is permitted between the nearest two points, the calculated minimum CLEARANCE being rounded up to the next higher 0,1 mm increment.</p> <p>If the CLEARANCE path is partly along the surface of insulation that is not Material Group I, the test voltage is applied across the air gap and Material Group I only. The part of the path along the surface of any other insulating material is bypassed.</p> <p>The values in parentheses apply to BASIC INSULATION, SUPPLEMENTARY INSULATION or REINFORCED INSULATION if manufacturing is subjected to a quality control programme that provides at least the same level of assurance as the example given in Clause R.2 of Annex R. DOUBLE INSULATION and REINFORCED INSULATION shall be subjected to ROUTINE TESTS for electric strength.</p> | | | | | | | | | | | | | | | | | | |
| <p>^a For transient overvoltages higher than 2 500 V peak, either Table 2K shall be used or the minimum CLEARANCE shall be determined using Annex G.</p> | | | | | | | | | | | | | | | | | | |
| <p>^b It is not required to pass the tests of 2.10.10 for Pollution Degree 1.</p> | | | | | | | | | | | | | | | | | | |
| <p>^c In a SECONDARY CIRCUIT, for PEAK WORKING VOLTAGES above 1 400 V, the minimum CLEARANCE is 5 mm provided that the CLEARANCE path passes an electric strength test according to 5.2.2 using:</p> <ul style="list-style-type: none"> - an a.c. test voltage whose r.m.s. value is 106 % of the PEAK WORKING VOLTAGE (peak value is 150 % of the PEAK WORKING VOLTAGE), or - a d.c. test voltage equal to 150 % of the PEAK WORKING VOLTAGE. | | | | | | | | | | | | | | | | | | |

2.10.3.5 Clearances in circuits having starting pulses

For a circuit generating starting pulses to ignite a discharge lamp, and if the circuit is not a LIMITED CURRENT CIRCUIT complying with 2.4 (see 2.10.1.7), the adequacy of CLEARANCES is determined by one of the following methods:

- a) *Determine the minimum CLEARANCE in accordance with Annex G; or*
- b) *Conduct electric strength tests, using one of the following procedures. During the tests, the lamp terminals are shorted together.*
 - *Test in accordance with 5.2.2, using an a.c. peak or d.c. test voltage equal to 150 % of the PEAK WORKING VOLTAGE; or*
 - *Apply 30 pulses having amplitude equal to 150 % the PEAK WORKING VOLTAGE from an external pulse generator. The pulse width shall be equal to or greater than that of the internally generated starting pulse.*

NOTE For WORKING VOLTAGES see 2.10.2.1 i).

2.10.3.6 Transients from an a.c. mains supply

Except as permitted below, the highest transient in a SECONDARY CIRCUIT due to transients on the AC MAINS SUPPLY is the value measured in accordance with 2.10.3.9 a).

Alternatively, for certain SECONDARY CIRCUITS it is permitted to assume that the highest transient is either of the following:

- the value measured in accordance with 2.10.3.9 a); or
- one step lower in the following list than the MAINS TRANSIENT VOLTAGE from Table 2J in the PRIMARY CIRCUIT:

330, 500, 800, 1 500, 2 500 and 4 000 V peak.

This is permitted in the following cases:

- a SECONDARY CIRCUIT, derived from an AC MAINS SUPPLY, that is connected to the main protective earthing terminal in accordance with 2.6.1;
- a SECONDARY CIRCUIT, derived from an AC MAINS SUPPLY and separated from the PRIMARY CIRCUIT by a metal screen that is connected to the main protective earthing terminal in accordance with 2.6.1.

2.10.3.7 Transients from a d.c. mains supply

NOTE 1 A circuit connected to a DC MAINS SUPPLY is considered to be a SECONDARY CIRCUIT(see 1.2.8.2).

The highest transient in a SECONDARY CIRCUIT due to transients on a DC MAINS SUPPLY is

- the MAINS TRANSIENT VOLTAGE, if the SECONDARY CIRCUIT is directly connected to the DC MAINS SUPPLY; or
- the value measured in accordance with 2.10.3.9 a) in other cases except as given in 2.10.3.2 b) and 2.10.3.2 c).

NOTE 2 Both of the above options depend on the value of the MAINS TRANSIENT VOLTAGE. In some cases, this value is assumed to be 71 V peak [see 2.10.3.2 b) or d)]. The appropriate column of Table 2K is used and no measurement is necessary.

2.10.3.8 Transients from telecommunication networks and cable distribution systems

If the TELECOMMUNICATION NETWORK TRANSIENT VOLTAGE is known for the TELECOMMUNICATION NETWORK in question, it is permitted to use the known value in 2.10.3.4.

If the TELECOMMUNICATION NETWORK TRANSIENT VOLTAGE is not known, the following value shall be used:

- 1 500 V peak if the circuit connected to the TELECOMMUNICATION NETWORK is a TNV-1 CIRCUIT or a TNV-3 CIRCUIT; and
- 800 V peak if the circuit connected to the TELECOMMUNICATION NETWORK is an SELV CIRCUIT or a TNV-2 CIRCUIT.

If incoming transients are attenuated within the equipment, it is permitted to use the value measured in accordance with 2.10.3.9 b).

The effect of a telephone ringing signal is not taken into account.

The effect of transients from a CABLE DISTRIBUTION SYSTEM is not taken into account (however, see 7.4.1).

2.10.3.9 Measurement of transient voltages

The following tests are conducted only if it is required to determine whether or not the transient voltage across the CLEARANCE in any circuit is lower than normal (for example, due to the effect of a filter in the equipment). The transient voltage across the CLEARANCE is measured using the following test procedure.

During the tests, the equipment is connected to its separate power supply unit, if any, but is not connected to the MAINS SUPPLY or to any TELECOMMUNICATION NETWORKS, and any surge suppressors in PRIMARY CIRCUITS are disconnected.

A voltage-measuring device is connected across the CLEARANCE in question.

a) Transients from a MAINS SUPPLY

To measure a transient voltage across a CLEARANCE due to transients on a MAINS SUPPLY, the impulse test generator reference 2 of Table N.1 is used to generate 1,2/50 μ s impulses. U_c is equal to the MAINS TRANSIENT VOLTAGE given in Table 2J.

Three to six impulses of alternating polarity, with intervals of at least 1 s between impulses, are applied between each of the following points where relevant:

For an AC MAINS SUPPLY

- *line-to-line;*
- *all line conductors joined together and neutral;*
- *all line conductors joined together and protective earth;*
- *neutral and protective earth.*

For a DC MAINS SUPPLY

- the positive and negative supply connection points;
- all supply connection points joined together and protective earth.

b) Transients from a TELECOMMUNICATION NETWORK

To measure the transient voltage across a CLEARANCE due to transients on a TELECOMMUNICATION NETWORK, the impulse test generator reference 1 of Table N.1 is used to generate 10/700 μ s impulses. U_c is equal to the TELECOMMUNICATION NETWORK TRANSIENT VOLTAGE determined in 2.10.3.8.

Three to six impulses of alternating polarity, with intervals of at least 1 s between impulses, are applied between each of the following TELECOMMUNICATION NETWORK connection points of a single interface type:

- each pair of terminals (for example, A and B or tip and ring) in an interface;
- all terminals of a single interface type joined together and earth.

Where there are several identical circuits, only one is tested.

2.10.4 Creepage distances**2.10.4.1 General**

CREEPAGE DISTANCES shall be so dimensioned that, for a given RMS WORKING VOLTAGE and pollution degree, no flashover or breakdown of insulation (for example, due to tracking) will occur.

2.10.4.2 Material group and comparative tracking index

Material groups depend on the comparative tracking index (CTI) and are classified as follows:

| | |
|---------------------|----------------------|
| Material Group I | CTI \geq 600 |
| Material Group II | 400 \leq CTI < 600 |
| Material Group IIIa | 175 \leq CTI < 400 |
| Material Group IIIb | 100 \leq CTI < 175 |

The material group is verified by evaluation of the test data for the material according to IEC 60112 using 50 drops of solution A.

If the material group is not known, Material Group IIIb shall be assumed.

If a CTI of 175 or greater is needed, and the data is not available, the material group can be established with a test for proof tracking index (PTI) as detailed in IEC 60112. A material may be included in a group if its PTI established by these tests is equal to, or greater than, the lower value of the CTI specified for the group.

2.10.4.3 Minimum creepage distances

CREEPAGE DISTANCES shall be not less than the appropriate minimum values specified in Table 2N.

If the minimum CREEPAGE DISTANCE derived from Table 2N is less than the applicable minimum CLEARANCE, that value of minimum CLEARANCE shall be applied as the minimum CREEPAGE DISTANCE.

For glass, mica, glazed ceramic, or similar inorganic materials, if the minimum CREEPAGE DISTANCE is greater than the applicable minimum CLEARANCE, it is permitted to apply that value of minimum CLEARANCE as the minimum CREEPAGE DISTANCE.

The CREEPAGE DISTANCE between the BOUNDING SURFACE of a connector and conductive parts within the connector that are connected to a HAZARDOUS VOLTAGE shall comply with the requirements for REINFORCED INSULATION. As an exception, for connectors that are

- fixed to the equipment; and
- located internal to the outer ENCLOSURE of the equipment; and
- only accessible after removal of a USER-replaceable subassembly that is required to be in place during normal operation,

this CREEPAGE DISTANCE shall comply with the requirements for BASIC INSULATION.

NOTE The tests of 2.1.1.1 for access to hazardous parts apply to such connectors after removal of the subassembly.

For all other CREEPAGE DISTANCES in connectors, including connectors that are not fixed to the equipment, the minimum values specified in Table 2N apply.

The above minimum CREEPAGE DISTANCES for connectors do not apply to connectors that comply with a standard harmonized with IEC 60083, IEC 60309, IEC 60320, IEC 60906-1 or IEC 60906-2, see also 1.5.2.

Compliance is checked by measurement, taking into account Annex F. The following conditions apply:

- *movable parts are placed in their most unfavourable positions;*
- *for equipment incorporating ordinary NON-DETACHABLE POWER SUPPLY CORDS, CREEPAGE DISTANCE measurements are made with supply conductors of the largest cross-sectional area specified in 3.3.4 for the terminal in question, and also without conductors; and*
- *when measuring CREEPAGE DISTANCES from the BOUNDING SURFACE of an ENCLOSURE of insulating material through a slot or opening in the ENCLOSURE or through an opening in an accessible connector, the accessible surface is considered to be conductive as if it were covered by metal foil wherever it can be touched by the test finger, Figure 2A (see 2.1.1.1), applied without appreciable force (see Figure F.12, point X).*

Table 2N – Minimum creepage distances

CREEPAGE DISTANCES in mm

| RMS WORKING VOLTAGE up to and including V | Pollution degree | | | | | | | | |
|---|-------------------|-------------|-------------------|----------------|------|------------|------|------|-----------------------|
| | 1 ^a | 2 | 1 ^a | 2 | | 3 | | | |
| | Printed boards | | | Material group | | | | | |
| | I, II, IIIa, IIIb | I, II, IIIa | I, II, IIIa, IIIb | I | II | IIIa, IIIb | I | II | IIIa, IIIb (see Note) |
| 10 | 0,025 | 0,04 | 0,08 | 0,4 | 0,4 | 0,4 | 1,0 | 1,0 | 1,0 |
| 12,5 | 0,025 | 0,04 | 0,09 | 0,42 | 0,42 | 0,42 | 1,05 | 1,05 | 1,05 |
| 16 | 0,025 | 0,04 | 0,1 | 0,45 | 0,45 | 0,45 | 1,1 | 1,1 | 1,1 |
| 20 | 0,025 | 0,04 | 0,11 | 0,48 | 0,48 | 0,48 | 1,2 | 1,2 | 1,2 |
| 25 | 0,025 | 0,04 | 0,125 | 0,5 | 0,5 | 0,5 | 1,25 | 1,25 | 1,25 |
| 32 | 0,025 | 0,04 | 0,14 | 0,53 | 0,53 | 0,53 | 1,3 | 1,3 | 1,3 |
| 40 | 0,025 | 0,04 | 0,16 | 0,56 | 0,8 | 1,1 | 1,4 | 1,6 | 1,8 |
| 50 | 0,025 | 0,04 | 0,18 | 0,6 | 0,85 | 1,2 | 1,5 | 1,7 | 1,9 |
| 63 | 0,04 | 0,063 | 0,2 | 0,63 | 0,9 | 1,25 | 1,6 | 1,8 | 2,0 |
| 80 | 0,063 | 0,10 | 0,22 | 0,67 | 0,9 | 1,3 | 1,7 | 1,9 | 2,1 |
| 100 | 0,1 | 0,16 | 0,25 | 0,71 | 1,0 | 1,4 | 1,8 | 2,0 | 2,2 |
| 125 | 0,16 | 0,25 | 0,28 | 0,75 | 1,05 | 1,5 | 1,9 | 2,1 | 2,4 |
| 160 | 0,25 | 0,40 | 0,32 | 0,8 | 1,1 | 1,6 | 2,0 | 2,2 | 2,5 |
| 200 | 0,4 | 0,63 | 0,42 | 1,0 | 1,4 | 2,0 | 2,5 | 2,8 | 3,2 |
| 250 | 0,56 | 1,0 | 0,56 | 1,25 | 1,8 | 2,5 | 3,2 | 3,6 | 4,0 |
| 320 | 0,75 | 1,6 | 0,75 | 1,6 | 2,2 | 3,2 | 4,0 | 4,5 | 5,0 |
| 400 | 1,0 | 2,0 | 1,0 | 2,0 | 2,8 | 4,0 | 5,0 | 5,6 | 6,3 |
| 500 | 1,3 | 2,5 | 1,3 | 2,5 | 3,6 | 5,0 | 6,3 | 7,1 | 8,0 |
| 630 | 1,8 | 3,2 | 1,8 | 3,2 | 4,5 | 6,3 | 8,0 | 9,0 | 10 |
| 800 | 2,4 | 4,0 | 2,4 | 4,0 | 5,6 | 8,0 | 10 | 11 | 12,5 |
| 1 000 | 3,2 | 5,0 | 3,2 | 5,0 | 7,1 | 10 | 12,5 | 14 | 16 |
| 1 250 | | | 4,2 | 6,3 | 9,0 | 12,5 | 16 | 18 | 20 |
| 1 600 | | | 5,6 | 8,0 | 11 | 16 | 20 | 22 | 25 |
| 2 000 | | | 7,5 | 10 | 14 | 20 | 25 | 28 | 32 |
| 2 500 | | | 10 | 12,5 | 18 | 25 | 32 | 36 | 40 |
| 3 200 | | | 12,5 | 16 | 22 | 32 | 40 | 45 | 50 |
| 4 000 | | | 16 | 20 | 28 | 40 | 50 | 56 | 63 |
| 5 000 | | | 20 | 25 | 36 | 50 | 63 | 71 | 80 |
| 6 300 | | | 25 | 32 | 45 | 63 | 80 | 90 | 100 |
| 8 000 | | | 32 | 40 | 56 | 80 | 100 | 110 | 125 |
| 10 000 | | | 40 | 50 | 71 | 100 | 125 | 140 | 160 |
| 12 500 | | | 50 | 63 | 90 | 125 | | | |
| 16 000 | | | 63 | 80 | 110 | 160 | | | |
| 20 000 | | | 80 | 100 | 140 | 200 | | | |
| 25 000 | | | 100 | 125 | 180 | 250 | | | |
| 32 000 | | | 125 | 160 | 220 | 320 | | | |
| 40 000 | | | 160 | 200 | 280 | 400 | | | |
| 50 000 | | | 200 | 250 | 360 | 500 | | | |
| 63 000 | | | 250 | 320 | 450 | 600 | | | |

The values in the table apply to FUNCTIONAL INSULATION if required by 5.3.4 a) (see 2.10.1.3), BASIC INSULATION and SUPPLEMENTARY INSULATION. For REINFORCED INSULATION the values are twice those in the table. Linear interpolation is permitted between the nearest two points, the calculated minimum CREEPAGE DISTANCE being rounded to the next higher 0,1 mm increment. For REINFORCED INSULATION, the calculated value for BASIC INSULATION shall be doubled first before applying the rounding off.

NOTE Material Group IIIb is not recommended for applications in Pollution Degree 3 with an RMS WORKING VOLTAGE above 630 V.

^a It is permitted to use the values for Pollution Degree 1 if one sample passes the tests of 2.10.10.

2.10.5 Solid insulation

2.10.5.1 General

In 2.10.5, the requirements for SOLID INSULATION (except those for thin sheet material) and for insulating compound also apply to gel materials, used for this purpose.

SOLID INSULATION shall be:

- so dimensioned that overvoltages, including transients, that enter the equipment, and peak voltages that may be generated within the equipment, do not break down the SOLID INSULATION; and
- so arranged that the likelihood of breakdown occurring due to the presence of pinholes in thin layers of insulation is limited.

Solvent-based enamel is accepted only on winding wire as described in 2.10.5.13.

Except for printed boards, SOLID INSULATION shall either

- comply with minimum distances through insulation in accordance with 2.10.5.2; or
- meet the requirements and pass the tests in 2.10.5.3 to 2.10.5.13, as applicable.

NOTE 1 For printed boards, see 2.10.6.

NOTE 2 For SOLID INSULATION on internal wiring, see 3.1.4.

Compliance with the requirements of 2.10.5.2 to 2.10.5.14 for the adequacy of SOLID INSULATION is verified by inspection and measurement, taking into account Annex F, by the electric strength tests of 5.2 and by any additional tests required in 2.10.5.4 to 2.10.5.14.

2.10.5.2 Distances through insulation

If a design is based on distances through insulation, these distances shall be dimensioned according to the application of the insulation (see 2.9) and as follows (see Figure F.14):

- if the PEAK WORKING VOLTAGE does not exceed 71 V, there is no requirement for distance through insulation;
- if the PEAK WORKING VOLTAGE exceeds 71 V, the following rules apply:
 - for FUNCTIONAL INSULATION and BASIC INSULATION there is no minimum distance through insulation;
 - SUPPLEMENTARY INSULATION or REINFORCED INSULATION shall have a distance through insulation that is 0,4 mm or greater, provided by a single layer.

For compliance criteria, see 2.10.5.1.

2.10.5.3 Insulating compound as solid insulation

NOTE 1 For printed boards, see 2.10.6 and for wound components, see 2.10.5.11, 2.10.5.12, 2.10.5.13 and 2.10.5.14.

There is no minimum internal CLEARANCE or CREEPAGE DISTANCE if insulating compound completely fills the casing of a component or subassembly, provided that each distance through insulation in the component or subassembly meets the requirements of 2.10.5.2 and a single sample passes the tests of 2.10.10.

NOTE 2 Some examples of such treatment are variously known as potting, encapsulation and vacuum impregnation.

NOTE 3 Such constructions may contain cemented joints, in which case 2.10.5.5 also applies.

For compliance criteria, see 2.10.5.1.

2.10.5.4 Semiconductor devices

There is no minimum distance through insulation for SUPPLEMENTARY INSULATION or REINFORCED INSULATION consisting of an insulating compound completely filling the casing of a semiconductor component (for example, an optocoupler, see Figure F.17), provided that the component satisfies one of the following, a) or b):

- a) – passes the TYPE TESTS and inspection criteria of 2.10.11; and
 - passes ROUTINE TESTS for electric strength during manufacturing, using the appropriate value of the test voltage in 5.2.2; or
- b) for an optocoupler only, complies with the requirements of IEC 60747-5-5¹⁾, where the test voltages as specified in 5.2.6 (of IEC 60747-5-5):
 - the voltage $V_{ini,a}$ for TYPE TESTING and
 - the voltage $V_{ini,b}$ for ROUTINE TESTING,
 shall be the appropriate value of the test voltage in 5.2.2 of this standard.

NOTE The above constructions may contain cemented joints, in which case 2.10.5.5 also applies.

As an alternative to a) and b) above, it is permitted to treat a semiconductor according to 2.10.5.3, if applicable.

For compliance criteria, see 2.10.5.1.

2.10.5.5 Cemented joints

Where the path between conductive parts is filled with insulating compound, and the insulating compound forms a cemented joint between two non-conductive parts (see Figure F.18) or between a non-conductive part and itself (see Figures F.16 and F.17), one of the following, a), b) or c) applies.

- a) The distance along the path between the two conductive parts shall not be less than the minimum CLEARANCES and CREEPAGE DISTANCES for Pollution Degree 2. The requirements for distance through insulation of 2.10.5.2 do not apply along the joint.
- b) The distance along the path between the two conductive parts shall not be less than the minimum CLEARANCES and CREEPAGE DISTANCES for Pollution Degree 1. Additionally, one sample shall pass the test of 2.10.10. The requirements for distance through insulation of 2.10.5.2 do not apply along the joint.
- c) The requirements for distance through insulation of 2.10.5.2 apply between the conductive parts along the joint. Additionally, three samples shall pass the test of 2.10.11.

¹⁾ To be published.

For a) and b) above, if the insulating materials involved have different material groups, the worst case is used. If a material group is not known, Material Group IIIb shall be assumed.

For b) and c) above, the tests of 2.10.10 and 2.10.11 are not applied to a printed board made using pre-preg if the temperature of the printed board measured during the test of 4.5.2 does not exceed 90 °C.

NOTE 1 No actual CLEARANCE or CREEPAGE DISTANCE exists unless the joint comes apart, for example, due to ageing. To cover this possibility, the requirements and tests of c) apply if the minimum CLEARANCES and CREEPAGE DISTANCES according to a) or b) are not met.

NOTE 2 Some examples of cemented joints are as follows:

- between two non-conductive parts cemented together, for example, two layers of a multilayer printed board (see Figure F.16) or the split bobbin of a transformer where the partition is secured by adhesive (see Figure F.18);
- between spirally wrapped layers of insulation on winding wire, sealed by adhesive;
- between the non-conductive casing of an optocoupler and insulating compound filling the casing (see Figure F.17).

For compliance criteria, see 2.10.5.1.

2.10.5.6 Thin sheet material - General

There is no dimensional or constructional requirement for insulation in thin sheet material used as FUNCTIONAL INSULATION or BASIC INSULATION.

Insulation in thin sheet materials permitted for SUPPLEMENTARY INSULATION and REINFORCED INSULATION (see Figure F.15), irrespective of the distance through insulation, provided that all of the following apply:

- two or more layers are used;
- the insulation is within the equipment ENCLOSURE;
- the insulation is not subject to handling or abrasion during OPERATOR servicing; and
- the requirements and tests of 2.10.5.7 (for separable layers) or 2.10.5.8 (for non-separable layers) are met.

It is not required for the two or more layers to be fixed to the same conductive part. The two or more layers can be

- fixed to one of the conductive parts requiring separation, or
- shared between the two conductive parts, or
- not fixed to either conductive part.

2.10.5.7 Separable thin sheet material

For insulation in separable thin sheet layers, in addition to the requirements of 2.10.5.6,

- SUPPLEMENTARY INSULATION shall consist of at least two layers of material, each of which will pass the electric strength test for SUPPLEMENTARY INSULATION; or
- SUPPLEMENTARY INSULATION shall consist of three layers of material for which all combinations of two layers together will pass the electric strength test for SUPPLEMENTARY INSULATION; or
- REINFORCED INSULATION shall consist of at least two layers of material, each of which will pass the electric strength test for REINFORCED INSULATION; or

- REINFORCED INSULATION shall consist of three layers of material for which all combinations of two layers together will pass the electric strength test for REINFORCED INSULATION.

It is permitted for different layers of insulation to be of different materials or different thicknesses, or both.

Compliance is checked by inspection and by the electric strength test of 2.10.5.9 or 2.10.5.10.

2.10.5.8 Non-separable thin sheet material

For insulation consisting of non-separable thin sheet materials, in addition to the requirements of 2.10.5.6, the test procedures in Table 2P are applied.

It is permitted for different layers of insulation to be of different materials or different thicknesses, or both.

Compliance is checked by inspection and by the tests specified in Table 2P.

Table 2P – Tests for insulation in non-separable layers

| Number of layers | Test procedure |
|---|--|
| SUPPLEMENTARY INSULATION | |
| Two or more layers: | The test procedure of 2.10.5.9 is applied. ^a |
| REINFORCED INSULATION | |
| Two layers: | The test procedure of 2.10.5.9 is applied. ^a |
| Three or more layers: | The test procedures of 2.10.5.9 and Annex AA are applied. ^a |
| ^a The alternative test procedure of 2.10.5.10 cannot be used for non-separable layers | |
| NOTE The purpose of the tests in Annex AA is to ensure that the material has adequate strength to resist damage when hidden in inner layers of insulation. Therefore, the tests are not applied to insulation in two layers. The tests in Annex AA are not applied to SUPPLEMENTARY INSULATION. | |

2.10.5.9 Thin sheet material - standard test procedure

For separable or non-separable layers, electric strength tests are applied in accordance with 5.2.2 to all layers together. The test voltage is:

- 200 % of U_{test} if two layers are used; or
- 150 % of U_{test} if three or more layers are used,

where U_{test} is the test voltage specified in 5.2.2 for SUPPLEMENTARY INSULATION or REINFORCED INSULATION as appropriate.

NOTE Unless all the layers are of the same material and have the same thickness, there is a possibility that the test voltage will be shared unequally between layers, causing breakdown of a layer that would have passed if tested separately.

2.10.5.10 Thin sheet material - alternative test procedure

If layers can be separated for individual testing, the following alternative to the standard test procedure in 2.10.5.9 is permitted.

Electric strength tests are applied in accordance with 5.2.2, using test voltages equal to the test voltage specified in 5.2.2 for SUPPLEMENTARY INSULATION or REINFORCED INSULATION as appropriate.

If two layers are used, each layer shall pass the test.

If three or more layers are used, each combination of two layers together shall pass the test.

If three or more layers are used, it is permitted to divide these layers into two or three groups for testing purposes. In the above electric strength tests, two or three groups are tested instead of two or three layers.

A test on a layer or group of layers is not repeated on an identical layer or group.

2.10.5.11 Insulation in wound components

Planar transformers are not considered to be wound components.

NOTE 1 Planar transformers are subject to the requirements covering the construction of printed boards, see 2.10.6.

There is no dimensional or constructional requirement for FUNCTIONAL INSULATION in a wound component.

It is permitted for BASIC INSULATION, SUPPLEMENTARY INSULATION or REINFORCED INSULATION in a wound component to be provided by

- the insulation on winding wire or other wire (see 2.10.5.12 or 2.10.5.13); or
- other insulation (see 2.10.5.14); or
- a combination of the two.

NOTE 2 Wound components may contain cemented joints, in which case 2.10.5.5 also applies.

For DOUBLE INSULATION between the conductor of a wire and another conductive part, it is permitted for BASIC INSULATION to be provided by insulation complying with 2.10.5.12 on one of the wires and SUPPLEMENTARY INSULATION by additional insulation complying with 2.10.5.14, or vice versa.

For compliance criteria see 2.10.5.1.

Additionally, BASIC INSULATION, SUPPLEMENTARY INSULATION and REINFORCED INSULATION in finished wound components shall pass ROUTINE TESTS for electric strength in accordance with 5.2.2.

2.10.5.12 Wire in wound components

The following requirements apply to winding wire and other wire whose insulation provides BASIC INSULATION, SUPPLEMENTARY INSULATION or REINFORCED INSULATION, as required.

Solvent-based enamel is not considered to provide BASIC INSULATION, SUPPLEMENTARY INSULATION or REINFORCED INSULATION. Solvent-based enamel is only accepted if used as winding wire insulation as described in 2.10.5.13.

NOTE 1 For insulation provided in addition to insulation on winding wire, see 2.10.5.14.

If the PEAK WORKING VOLTAGE does not exceed 71 V, there is no dimensional or constructional requirement.

If the PEAK WORKING VOLTAGE exceeds 71 V, one of the following, a), b), or c), applies:

a) For BASIC INSULATION that is not under stress (for example, from winding tension), there is no dimensional or constructional requirement. For BASIC INSULATION that is under such stress, b), or c) applies.

NOTE 2 The exception in a) does not apply to SUPPLEMENTARY INSULATION or REINFORCED INSULATION.

b) For BASIC INSULATION, SUPPLEMENTARY INSULATION or REINFORCED INSULATION, the insulation on the wire shall either:

- have a thickness of at least of 0,4 mm provided by a single layer; or
- comply with 2.10.5.6 and with Annex U.

c) The winding wire shall comply with Annex U. In addition, the minimum number of overlapping layers of spirally wrapped tape or extruded layers of insulation shall be as follows:

- for BASIC INSULATION: one layer;
- for SUPPLEMENTARY INSULATION: two layers;
- for REINFORCED INSULATION: three layers.

For insulation between two adjacent winding wires, one layer on each conductor is considered to provide SUPPLEMENTARY INSULATION.

Spirally wrapped tape wound with less than 50 % overlap is considered to constitute one layer.

Spirally wrapped tape wound with more than 50 % overlap is considered to constitute two layers.

Spirally wrapped tape shall be sealed and pass the tests of 2.10.5.5 a), b), or c).

NOTE 3 For wires insulated by an extrusion process, sealing is inherent to the process.

Where two winding wires, or one winding wire and another wire, are in contact inside the wound component, crossing each other at an angle between 45° and 90° and subject to winding tension, protection against mechanical stress shall be provided. This protection can be achieved, for example, by providing physical separation in the form of insulating sleeving or sheet material, or by using double the required number of insulation layers.

For compliance criteria see 2.10.5.1. If the tests of Annex U are required, they are not repeated if the material data sheets confirm compliance.

2.10.5.13 Wire with solvent-based enamel in wound components

It is permitted to use solvent-based enamel on winding wire to provide electrical separation that is considered to meet the requirements of 2.3.2.1.

NOTE 1 Solvent-based enamel is not considered to provide BASIC INSULATION, SUPPLEMENTARY INSULATION or REINFORCED INSULATION, see 2.10.5.12.

The insulation on all conductors shall be enamel complying with the requirements of a grade 2 winding wire in compliance with one of the IEC 60317 series of standards with the TYPE TEST conducted at a test voltage that is not less than required by 5.2.2.

Compliance is checked by inspection and by the following tests.

The finished component is subjected to a TYPE TEST for electric strength (between windings; and between windings and the core (see Clause C.2) in accordance with 5.2.2.

The finished component is also subjected to ROUTINE TESTS for the electric strength of the electrical separation in accordance with 5.2.2, using a test voltage of 1 000 V.

The dimensional and constructional requirements of 2.10 and Annex G do not apply for compliance with 2.10.5.13.

NOTE 2 In some cases, 6.1.2.1 also applies.

(C) Note deleted **(C)**

2.10.5.14 Additional insulation in wound components

The following requirements apply to insulation in a wound component, provided in addition to the insulation on winding wire or other wire. This includes, for example:

- insulation between windings; and
- insulation between a winding wire or other wire and any other conductive part in the wound component.

NOTE For insulation on the winding wire itself, see 2.10.5.12.

If the PEAK WORKING VOLTAGE does not exceed 71 V, there is no dimensional or constructional requirement.

If the PEAK WORKING VOLTAGE exceeds 71 V,

- for BASIC INSULATION that is not under mechanical stress, there is no dimensional or constructional requirement;
- SUPPLEMENTARY INSULATION OR REINFORCED INSULATION shall either
 - have a thickness of at least 0,4 mm, provided by single layer; or
 - comply with 2.10.5.6.

2.10.6 Construction of printed boards

NOTE 2.10.6 also applies to the windings of a planar transformer and a ceramic transformer.

2.10.6.1 Uncoated printed boards

The insulation between conductors on the outer surfaces of an uncoated printed board shall comply with the minimum CLEARANCE requirements of 2.10.3 (or Annex G) and the minimum CREEPAGE DISTANCE requirements of 2.10.4.

Compliance is checked by inspection and measurement.

2.10.6.2 Coated printed boards

For printed boards whose outer surfaces are to be coated with a suitable coating material, the following requirements apply to conductive parts before they are coated:

- the minimum separation distances of Table 2Q shall be met; and
- manufacturing is subjected to a quality control programme that provides at least the same level of assurance as the example given in Clause R.1 of Annex R. DOUBLE INSULATION and REINFORCED INSULATION shall pass ROUTINE TESTS for electric strength.

One or both conductive parts and at least 80 % of the distances over the surface between the conductive parts shall be coated.

The coating process, the coating material and the base material shall be such that uniform quality is assured and the separation distances under consideration are effectively protected.

The minimum CLEARANCES of 2.10.3 (or Annex G) and the minimum CREEPAGE DISTANCES of 2.10.4 apply

- if the above conditions are not met;
- between any two uncoated conductive parts; and
- over the outside of the coating.

Compliance is checked by inspection and measurement, taking Figure F.11 into account, and by the tests of 2.10.8.

Table 2Q – Minimum separation distances for coated printed boards

| PEAK WORKING VOLTAGE up to and including V peak | FUNCTIONAL, BASIC OR SUPPLEMENTARY INSULATION mm | REINFORCED INSULATION mm |
|---|--|-----------------------------|
| 90 | 0,1 | 0,2 |
| 180 | 0,2 | 0,4 |
| 230 | 0,3 | 0,6 |
| 285 | 0,4 | 0,8 |
| 355 | 0,6 | 1,2 |
| 455 | 0,8 | 1,6 |
| 570 | 1,0 | 2,0 |
| 710 | 1,3 | 2,6 |
| 895 | 1,8 | 3,6 |
| 1 135 | 2,4 | 3,8 |
| 1 450 | 2,8 | 4,0 |
| 1 800 | 3,4 | 4,2 |
| 2 300 | 4,1 | 4,6 |
| 2 850 | 5,0 | 5,0 |
| 3 550 | 6,3 | 6,3 |
| 4 550 | 8,2 | 8,2 |
| 5 700 | 10 | 10 |
| 7 100 | 13 | 13 |
| 8 950 | 16 | 16 |
| 11 350 | 20 | 20 |
| 14 200 | 26 | 26 |
| 18 000 | 33 | 33 |
| 23 000 | 43 | 43 |
| 28 500 | 55 | 55 |
| 35 500 | 70 | 70 |
| 45 500 | 86 | 86 |

Linear interpolation is permitted between the nearest two points, the calculated minimum separation distance being rounded up to the next higher 0,1 mm increment.
If the minimum CREEPAGE DISTANCE specified in Table 2N is smaller than the minimum separation distance specified above, the smaller distance applies.

2.10.6.3 Insulation between conductors on the same inner surface of a printed board

On an inner surface of a multi-layer printed board (see Figure F.16), the path between any two conductors shall comply with the requirements for a cemented joint in 2.10.5.5

2.10.6.4 Insulation between conductors on different surfaces of a printed board

SUPPLEMENTARY INSULATION OR REINFORCED INSULATION between conductive parts on different surfaces in double-sided single-layer printed boards, multi-layer printed boards and metal core printed boards, shall either:

- have a minimum thickness of 0,4 mm; or
- conform with one of the specifications and pass the relevant tests in Table 2R.

There is no corresponding requirement for FUNCTIONAL INSULATION OR BASIC INSULATION.

Compliance is checked by inspection and measurement and by tests where required.

Table 2R – Insulation in printed boards

| Specification of insulation | TYPE TESTS ^a | ROUTINE TESTS for electric strength ^c |
|---|-------------------------|--|
| Two layers of sheet insulating material including pre-preg ^b | No | Yes |
| Three or more layers of sheet insulating material including pre-preg ^b | No | No |
| An insulation system with ceramic coating over a metallic substrate, cured at ≥ 500 °C | No | Yes |
| An insulation system, with two or more coatings other than ceramic over a metallic substrate, cured at < 500 °C | Yes | Yes |
| NOTE 1 Pre-preg is the term used for a layer of glass cloth impregnated with a partially cured resin. | | |
| NOTE 2 For definition of ceramic, see IEC 212-05-24. | | |
| ^a Thermal conditioning of 2.10.8.2 followed by the electric strength test of 5.2.2. | | |
| ^b Layers are counted before curing. | | |
| ^c Electric strength testing is conducted on the finished printed board. | | |

2.10.7 Component external terminations

It is permitted to use coatings over external terminations of components to increase effective CLEARANCES and CREEPAGE DISTANCES (see Figure F.10). The minimum separation distances of Table 2Q apply to the component before coating, and the coating shall meet all the requirements of 2.10.6.2, including quality control provisions.

The mechanical arrangement and rigidity of the terminations shall be adequate to ensure that, during normal handling, assembly into equipment and subsequent use, the terminations will not be subject to deformation that would crack the coating or reduce the separation distances between conductive parts below the values in Table 2Q (see 2.10.6.2).

Compliance is checked by inspection taking into account Figure F.10 and by applying the sequence of tests covered by 2.10.8.1, 2.10.8.2 and 2.10.8.3. These tests are conducted on a completed assembly including the component(s).

Also, the abrasion resistance test of 2.10.8.4 is conducted on a specially prepared sample printed board as described for sample 3 in 2.10.8.1, except that the separation between the conductive parts shall be representative of the minimum separations and maximum potential gradients used in the assembly.

2.10.8 Tests on coated printed boards and coated components

2.10.8.1 Sample preparation and preliminary inspection

Three sample printed boards (or, for coated components in 2.10.7, two components and one board) identified as samples 1, 2 and 3 are required. It is permitted to use either actual boards or specially produced samples with representative coating and minimum separations. Each sample board shall be representative of the minimum separations used, and coated. Each sample is subjected to the full sequence of manufacturing processes, including soldering and cleaning, to which it is normally subjected during equipment assembly.

When visually inspected, the boards shall show no evidence of pinholes or bubbles in the coating or breakthrough of conductive tracks at corners.

2.10.8.2 Thermal conditioning

Sample 1 (see 2.10.8.1) is subjected to the thermal cycling sequence of 2.10.9.

Sample 2 is aged in a full draught oven at a temperature and for a time duration chosen from the graph of Figure 2J using the temperature index line that corresponds to the maximum operating temperature of the coated board. The temperature of the oven is maintained at the specified temperature ± 2 °C. The temperature used to determine the temperature index line is the highest temperature on the board where safety is involved.

When using Figure 2J, interpolation is permitted between the nearest two temperature index lines.

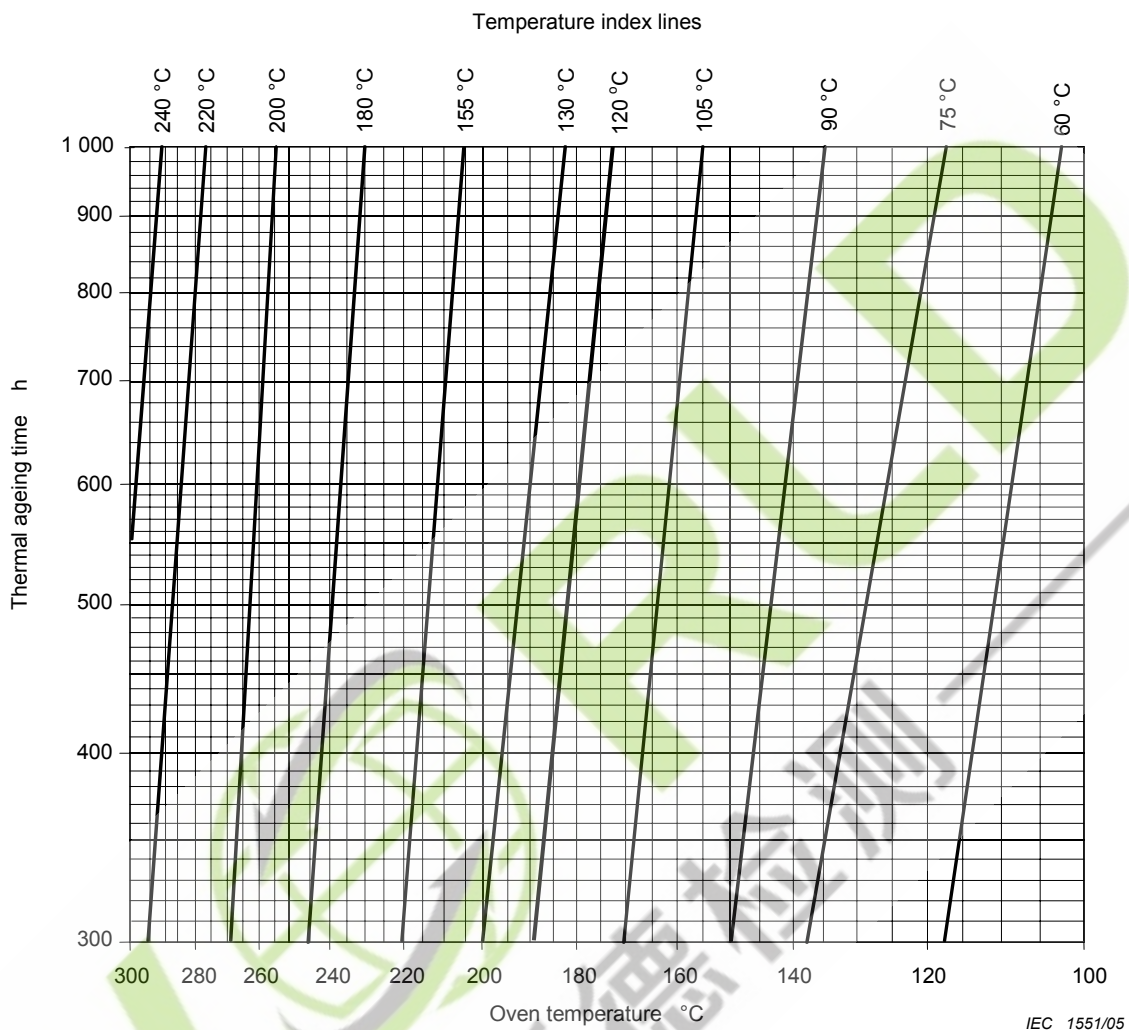

Figure 2J – Thermal ageing time

2.10.8.3 Electric strength test

Samples 1 and 2 (see 2.10.8.1) are then subjected to the humidity conditioning of 2.9.2 and shall withstand the relevant electric strength test of 5.2.2 between conductors.

2.10.8.4 Abrasion resistance test

Sample 3 (see 2.10.8.1) is subjected to the following test.

Scratches are made across five pairs of conducting parts and the intervening separations at points where the separations will be subject to the maximum potential gradient during the tests.

The scratches are made by means of a hardened steel pin, the end of which has the form of a cone having a tip angle of 40°, its tip being rounded and polished, with a radius of 0,25 mm ± 0,02 mm.

Scratches are made by drawing the pin along the surface in a plane perpendicular to the conductor edges at a speed of $20 \text{ mm/s} \pm 5 \text{ mm/s}$ as shown in Figure 2K. The pin is so loaded that the force exerted along its axis is $10 \text{ N} \pm 0,5 \text{ N}$. The scratches shall be at least 5 mm apart and at least 5 mm from the edge of the specimen.

After this test, the coating layer shall neither have loosened nor have been pierced, and it shall withstand an electric strength test as specified in 5.2.2 between conductors. In the case of metal core printed boards, the substrate is one of the conductors.

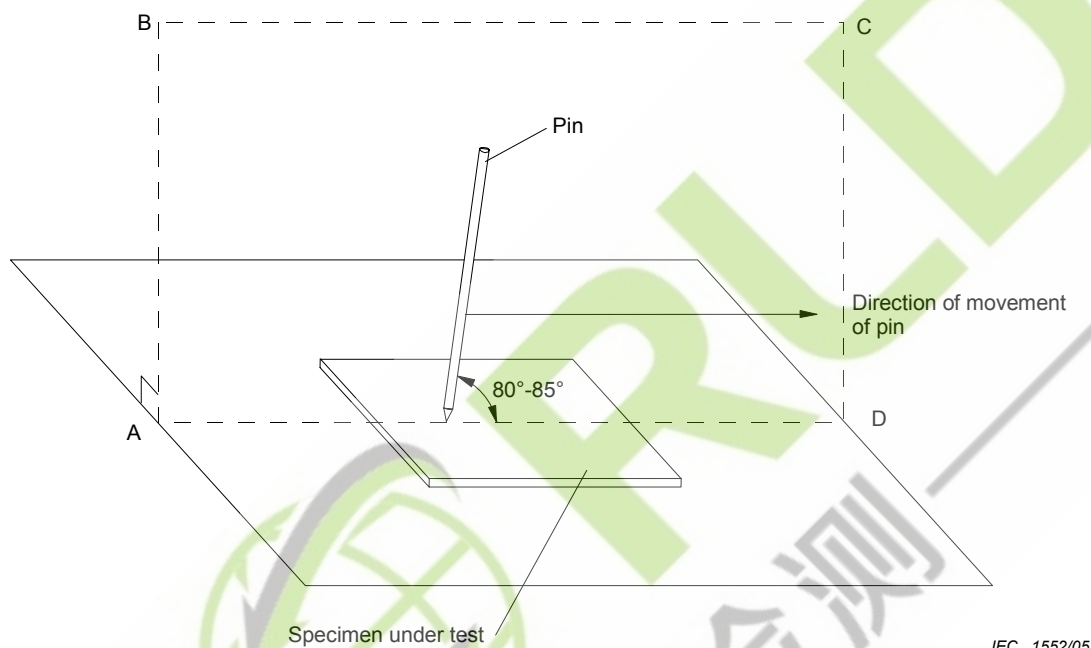

IEC 1552/05

NOTE The pin is in the plane ABCD which is perpendicular to the specimen under test.

Figure 2K – Abrasion resistance test for coating layers

2.10.9 Thermal cycling

The following thermal cycling sequence is used if required by 2.10.8.2, 2.10.10 or 2.10.11.

A sample of a component or subassembly is subjected to the following sequence of tests. For transformers, magnetic couplers and similar devices, if insulation is relied upon for safety, a voltage of 500 V r.m.s. at a frequency of 50 Hz or 60 Hz is applied between windings, and also between windings and other conductive parts during the following thermal cycling.

The sample is subjected ten times to the following sequence of thermal cycling:

| | |
|----------------------|--|
| 68 h at | $T_1 \pm 2 \text{ }^\circ\text{C}$; |
| 1 h at | $25 \text{ }^\circ\text{C} \pm 2 \text{ }^\circ\text{C}$; |
| 2 h at | $0 \text{ }^\circ\text{C} \pm 2 \text{ }^\circ\text{C}$; |
| not less than 1 h at | $25 \text{ }^\circ\text{C} \pm 2 \text{ }^\circ\text{C}$. |

$T_1 = T_2 + T_{ma} - T_{amb} + 10 \text{ K}$, measured in accordance with 1.4.5 and, where relevant, 1.4.13, or $85 \text{ }^\circ\text{C}$, whichever is the higher. However, the 10 K margin is not added if the temperature is measured by an embedded thermocouple or by the resistance method.

T_2 is the temperature of the parts measured during the test of 4.5.2.

The significance of T_{ma} and T_{amb} are as given in 1.4.12.1.

The period of time taken for the transition from one temperature to another is not specified, but the transition is permitted to be gradual.

There shall be no evidence of insulation breakdown during this conditioning.

2.10.10 Test for Pollution Degree 1 environment and for insulating compound

This test is conducted when it is required to verify a Pollution Degree 1 environment [when using Table 2N, 2.10.5.5 b) or Table G.2] or when required by 2.10.5.3 or 2.10.12.

NOTE It is not required to pass this test in connection with Tables 2K, 2L and 2M, where the requirements for Pollution Degree 1 are the same as for Pollution Degree 2.

A sample is subjected to the thermal cycling sequence of 2.10.9. The sample is permitted to cool to room temperature and is then subjected to the humidity conditioning of 2.9.2, followed immediately by the electric strength tests of 5.2.2.

The tests are followed by inspection and measurement. There shall be no cracks in the insulating material. For compliance with 2.10.5.3, the sample is also sectioned, and there shall be no voids in the insulating material.

2.10.11 Tests for semiconductor devices and for cemented joints

If required by 2.10.5.4 or 2.10.5.5 c), three samples are subjected to the thermal cycling sequence of 2.10.9. Before testing a cemented joint, any winding of solvent-based enamelled wire used in the component is replaced by metal foil or by a few turns of bare wire, placed close to the cemented joint.

The three samples are then tested as follows:

- one of the samples is subjected to the relevant electric strength test of 5.2.2, immediately after the last period at T_1 °C during thermal cycling, except that the test voltage is multiplied by 1,6;
- the other samples are subjected to the relevant electric strength test of 5.2.2 after the humidity conditioning of 2.9.2, except that the test voltage is multiplied by 1,6.

The tests are followed by inspection, including sectioning, and measurement. There shall be no voids or gaps or cracks in the insulating material. In the case of multilayer printed boards, there shall be no delamination.

2.10.12 Enclosed and sealed parts

For components or subassemblies that are adequately enclosed by enveloping or hermetic sealing to prevent ingress of dirt and moisture, the values for Pollution Degree 1 apply to internal CLEARANCES and CREEPAGE DISTANCES.

NOTE Some examples of such construction include parts in boxes that are hermetically sealed by adhesive or otherwise, and parts enveloped in a dip coat.

Compliance is checked by inspection from the outside, measurement and, if necessary, by test. A component or subassembly is considered to be adequately enclosed if a sample passes the tests of 2.10.10.

3 Wiring, connections and supply

3.1 General

3.1.1 Current rating and overcurrent protection

The cross-sectional area of internal wires and INTERCONNECTING CABLES shall be adequate for the current they are intended to carry when the equipment is operating under NORMAL LOAD such that the maximum permitted temperature of conductor insulation is not exceeded.

All internal wiring (including busbars) and INTERCONNECTING CABLES used in the distribution of PRIMARY CIRCUIT power shall be protected against overcurrent and short-circuit by suitably rated protective devices.

Wiring not directly involved in the distribution path does not require protection if it can be shown that creation of hazards is unlikely (for example, indicating circuits).

NOTE 1 Devices for overload protection of components may also provide protection of associated wiring.

NOTE 2 Internal circuits connected to a MAINS SUPPLY may require individual protection depending on reduced wire size and length of conductors.

Compliance is checked by inspection and, as appropriate, by the tests of 4.5.2 and 4.5.3.

3.1.2 Protection against mechanical damage

Wireways shall be smooth and free from sharp edges. Wires shall be protected so that they do not come into contact with burrs, cooling fins, moving parts, etc., which could cause damage to the insulation of conductors. Holes in metal, through which insulated wires pass, shall have smooth well-rounded surfaces or shall be provided with bushings.

It is permitted for wires to be in close contact with wire wrapping posts and the like if any breakdown of insulation will not create a hazard, or if adequate mechanical protection is provided by the insulation system.

Compliance is checked by inspection.

3.1.3 Securing of internal wiring

Internal wiring shall be routed, supported, clamped or secured in a manner that reduces the likelihood of:

- excessive strain on wire and on terminal connections; and
- loosening of terminal connections; and
- damage of conductor insulation.

Compliance is checked by inspection.

3.1.4 Insulation of conductors

Except as covered in 2.1.1.3 b), insulation of individual conductors of internal wiring shall fulfil the requirements of 2.10.5 and be capable of withstanding the applicable electric strength test specified in 5.2.2.

Where a power supply cord, whose insulating properties comply with those of the cord types of 3.2.5, is used inside the equipment, either as an extension of the external power supply cord or as an independent cable, the sheath of the power supply cord is considered to be adequate SUPPLEMENTARY INSULATION for the purpose of 3.1.4.

NOTE Requirements regarding colours of insulation are in 2.6.3.5.

Compliance is checked by inspection and evaluation of test data showing that the insulation withstands the relevant test voltage.

If such applicable test data is not available, compliance is checked by applying the electric strength test using a sample of approximately 1 m in length and by applying the relevant test voltage as follows:

- for insulation of a conductor: by the voltage test method given in Clause 3 of IEC 60885-1, using the relevant test voltage in 5.2.2 in this standard for the grade of insulation under consideration; and*
- for SUPPLEMENTARY INSULATION (for example, sleeving around a group of conductors): between a conductor inserted into the sleeve and metal foil wrapped tightly round the sleeve for a length of at least 100 mm.*

3.1.5 Beads and ceramic insulators

Beads and similar ceramic insulators on conductors shall:

- be so fixed or supported that they cannot change their position in such a way that a hazard would be created; and
- not rest on sharp edges or sharp corners.

If beads are located inside flexible metal conduits, they shall be contained within an insulating sleeve, unless the conduit is mounted or secured in such a way that movement in normal use would not create a hazard.

Compliance is checked by inspection and, where necessary, by the following test.

A force of 10 N is applied to the insulators or to the conduit. The resulting movement, if any, shall not create a hazard in the meaning of this standard.

3.1.6 Screws for electrical contact pressure

Where electrical contact pressure is required, a screw shall engage at least two complete threads into a metal plate, a metal nut or a metal insert.

Screws of insulating material shall not be used where electrical connections, including protective earthing, are involved, or where their replacement by metal screws could impair SUPPLEMENTARY INSULATION OR REINFORCED INSULATION.

Where screws of insulating material contribute to other safety aspects, they shall be engaged by at least two complete threads.

NOTE See also 2.6.5.7 for screws used for protective earthing continuity.

Compliance is checked by inspection.

3.1.7 Insulating materials in electrical connections

Electrical connections, including those for protective earthing functions (see 2.6), shall be so designed that contact pressure is not transmitted through insulating material unless there is sufficient resilience in the metallic parts to compensate for any possible shrinkage or distortion of the insulating material.

Compliance is checked by inspection.

3.1.8 Self-tapping and spaced thread screws

Spaced thread (sheet metal) screws shall not be used for the connection of current-carrying parts, unless they clamp these parts directly in contact with each other and are provided with a suitable means of locking.

Self-tapping (thread-cutting or thread-forming) screws shall not be used for the electrical connection of current-carrying parts, unless they generate a full form standard machine screw thread. Moreover, such screws shall not be used if they are operated by the USER or installer unless the thread is formed by a swaging action.

NOTE See also 2.6.5.7 for screws used for protective earthing continuity.

Compliance is checked by inspection.

3.1.9 Termination of conductors

Conductors shall be provided with a means (for example, barriers or fixing), or be so terminated, that they and their terminators (for example, ring terminals and flat quick-connect terminals) cannot, in normal use, become so displaced that CLEARANCES or CREEPAGE DISTANCES are reduced below the values specified in 2.10 (or Annex G).

It is permitted to use soldered, welded, crimped, screwless (push-in) and similar terminations for the connection of conductors. For soldered terminations, the conductor shall be positioned or fixed so that reliance is not placed upon the soldering alone to maintain the conductor in position.

In multiway plugs and sockets, and wherever shorting could otherwise occur, means shall be provided to prevent contact between parts in SELV CIRCUITS or TNV CIRCUITS and parts at HAZARDOUS VOLTAGE due to loosening of a terminal or breaking of a wire at a termination.

Compliance is checked by inspection, by measurement and, where necessary, by the following test.

A force of 10 N is applied to the conductor near its termination point. The conductor shall not break away or pivot on its terminal to the extent that CLEARANCES or CREEPAGE DISTANCES are reduced below the values specified in 2.10 (or Annex G).

For the purpose of assessing compliance it is assumed that:

- two independent fixings will not become loose at the same time; and
- parts fixed by means of screws or nuts provided with self-locking washers or other means of locking are not liable to become loose.

NOTE Spring washers and the like can provide satisfactory locking.

Examples of constructions regarded as meeting the requirements include:

- close-fitting tubing (for example, a heat shrink or rubber sleeve), applied over the wire and its termination;
- conductors connected by soldering and held in place near to the termination, independently of the soldered connection;
- conductors connected by soldering and "hooked in" before soldering, provided that the hole through which the conductor is passed is not unduly large;
- conductors connected to screw terminals, with an additional fixing near to the terminal that clamps, in the case of stranded conductors, the insulation and not only the conductors;
- conductors connected to screw terminals and provided with terminators that are unlikely to become free (for example, ring lugs crimped onto the conductors). The pivoting of such terminators is considered;
- short rigid conductors that remain in position when the terminal screw is loosened.

3.1.10 Sleeving on wiring

Where sleeving is used as SUPPLEMENTARY INSULATION on internal wiring, it shall be retained in position by positive means.

Compliance is checked by inspection.

Examples of constructions that are considered to meet the intent of this requirement include:

- sleeving that can be removed only by breaking or cutting of either the wiring or sleeving;
- sleeving that is clamped at both ends;
- heat shrinkable sleeving that tightens against the wire insulation;
- sleeving that is of such length that it will not slip.

3.2 Connection to a mains supply

3.2.1 Means of connection

3.2.1.1 Connection to an a.c. mains supply

For safe and reliable connection to an AC MAINS SUPPLY, equipment shall be provided with one of the following:

- terminals for permanent connection to the supply;
- a NON-DETACHABLE POWER SUPPLY CORD for permanent connection to the supply, or for connection to the supply by means of a plug;

Ⓒ Note deleted Ⓒ

- an appliance inlet for connection of a DETACHABLE POWER SUPPLY CORD;
- a mains plug that is part of DIRECT PLUG-IN EQUIPMENT.

Compliance is checked by inspection.

3.2.1.2 Connection to a d.c. mains supply

For safe and reliable connection to a DC MAINS SUPPLY, equipment shall be provided with one of the following:

- terminals for permanent connection to the supply;
- a NON-DETACHABLE POWER SUPPLY CORD for permanent connection to the supply, or for connection to the supply by means of a plug;
- an appliance inlet for connection of a DETACHABLE POWER SUPPLY CORD.

Plugs and appliance inlets shall not be of a type that is used for AC MAINS SUPPLIES if a hazard could be created by their use. Plugs and appliance inlets shall be so designed that reverse polarity connections are prevented if a hazard could be created by such connection.

It is permitted for one pole of the DC MAINS SUPPLY to be connected both to an equipment mains input terminal and to the main protective earthing terminal of the equipment, if any, provided the equipment installation instructions detail the proper earthing for the system.

Compliance is checked by inspection.

3.2.2 Multiple supply connections

If equipment is provided with more than one supply connection (for example, with different voltages or frequencies or as backup power), the design shall be such that all of the following conditions are met:

- separate means of connection are provided for different circuits; and
- supply plug connections, if any, are not interchangeable if a hazard could be created by incorrect plugging; and
- bare parts of an ELV CIRCUIT or parts at HAZARDOUS VOLTAGES, such as plug contacts, are not accessible to an OPERATOR when one or more connectors are disconnected.

Compliance is checked by inspection and for accessibility, where necessary, by a test with the test finger, Figure 2A (see 2.1.1.1).

3.2.3 Permanently connected equipment

PERMANENTLY CONNECTED EQUIPMENT shall be provided with either:

- a set of terminals as specified in 3.3; or
- a NON-DETACHABLE POWER SUPPLY CORD.

PERMANENTLY CONNECTED EQUIPMENT having a set of terminals shall:

- permit the connection of the supply wires after the equipment has been fixed to its support; and

- be provided with cable entries, conduit entries, knock-outs or glands, which allow connection of the appropriate types of cables or conduits.

For equipment having a RATED CURRENT not exceeding 16 A, the cable entries shall be suitable for cables and conduits having an overall diameter as shown in Table 3A.

Conduit and cable entries and knock-outs for supply connections shall be so designed or located that the introduction of the conduit and cable does not affect the protection against electric shock, or reduce CLEARANCES and CREEPAGE DISTANCES below the values specified in 2.10 (or Annex G).

Compliance is checked by inspection, by a practical installation test and by measurement.

Table 3A – Sizes of cables and conduits for equipment having a rated current not exceeding 16 A

| Number of conductors, including the PROTECTIVE EARTHING CONDUCTOR where provided | Overall diameter mm | |
|--|---------------------|---------------------------|
| | Cable | Conduit |
| 2 | 13,0 | 16,0 [C] Text deleted [C] |
| 3 | 14,0 | 16,0 [C] Text deleted [C] |
| 4 | 14,5 | 20,0 [C] Text deleted [C] |
| 5 | 15,5 | 20,0 [C] Text deleted [C] |
| [C] Note deleted [C] | | |

[C] Text deleted [C]

3.2.4 Appliance inlets

Appliance inlets shall meet all of the following:

- be so located or enclosed that parts at HAZARDOUS VOLTAGE are not accessible during insertion or removal of the connector (appliance inlets complying with IEC 60309 or with IEC 60320 are considered to comply with this requirement); and
- be so located that the connector can be inserted without difficulty; and
- be so located that, after insertion of the connector, the equipment is not supported by the connector for any position of normal use on a flat surface.

Compliance is checked by inspection and, for accessibility, by means of the test finger, Figure 2A (see 2.1.1.1).

[C] Note deleted [C]

3.2.5 Power supply cords

3.2.5.1 AC power supply cords

A power supply cord for connection to the AC MAINS SUPPLY shall comply with all of the following, as appropriate:

- if rubber insulated, be not lighter than ordinary tough rubber-sheathed flexible cord according to IEC 60245 (designation [C] H05 RR-F [C]); and
- if PVC insulated:
 - for equipment provided with a NON-DETACHABLE POWER SUPPLY CORD and having a mass not exceeding 3 kg, be not lighter than light PVC sheathed flexible cord according to IEC 60227 (designation [C] H03 VV-F or H03 VVH2-F [C]);
 - for equipment provided with a NON-DETACHABLE POWER SUPPLY CORD and having a mass exceeding 3 kg, be not lighter than ordinary PVC sheathed flexible cord according to IEC 60227 (designation [C] H05 VV-F or H05 VVH2-F2 [C]);
 - for equipment provided with a DETACHABLE POWER SUPPLY CORD, be not lighter than light PVC sheathed flexible cord according to IEC 60227 (designation [C] H03 VV-F or H03 VVH2-F [C]); and

NOTE 1 There is no limit on the mass of the equipment if the equipment is intended for use with a DETACHABLE POWER SUPPLY CORD.

- include, for equipment required to have protective earthing, a PROTECTIVE EARTHING CONDUCTOR having green-and-yellow insulation; and
- have conductors with cross-sectional areas not less than those specified in Table 3B.

[C] Note deleted [C]

Compliance is checked by inspection and by measurement. In addition, for screened cords, compliance is checked by the tests of IEC 60227 (all parts). However, flexing tests need be applied only to screened power supply cords for MOVABLE EQUIPMENT.

NOTE 3 Although screened cords are not covered in the Scope of IEC 60227, the relevant tests of IEC 60227 are used.

Damage to the screen is acceptable provided that

- *during the flexing test the screen does not make contact with any conductor, and*
- *after the flexing test, the sample withstands the electric strength test between the screen and all other conductors.*

Table 3B – Sizes of conductors

| RATED CURRENT of equipment A | Minimum conductor sizes | |
|----------------------------------|---|---|
| | Nominal cross-sectional area mm ² | AWG or kcmil [cross-sectional area in mm ²] see Note 2 |
| ☐ Up to and including 6 | 0,75 ^a | 18 [0,8] |
| Over 6 up to and including 10 | (0,75) ^b 1,0 | 16 [1,3] |
| Over 10 up to and including 16 | (1,0) ^c 1,5 | 16 [1,3] ☐ |
| Over 16 up to and including 25 | 2,5 | 12 [3] |
| Over 25 up to and including 32 | 4 | 10 [5] |
| Over 32 up to and including 40 | 6 | 8 [8] |
| Over 40 up to and including 63 | 10 | 6 [13] |
| Over 63 up to and including 80 | 16 | 4 [21] |
| Over 80 up to and including 100 | 25 | 2 [33] |
| Over 100 up to and including 125 | 35 | 1 [42] |
| Over 125 up to and including 160 | 50 | 0 [53] |
| Over 160 up to and including 190 | 70 | 000 [85] |
| Over 190 up to and including 230 | 95 | 0000 [107] |
| Over 230 up to and including 260 | 120 | 250 kcmil [126] |
| Over 260 up to and including 300 | 150 | 300 kcmil [152] |
| Over 300 up to and including 340 | 185 | 400 kcmil [202] |
| Over 340 up to and including 400 | 240 | 500 kcmil [253] |
| Over 400 up to and including 460 | 300 | 600 kcmil [304] |

NOTE 1 IEC 60320 specifies acceptable combinations of appliance couplers and flexible cords, including those covered by Footnotes a, b and c above. ☐ Text deleted ☐

NOTE 2 AWG and kcmil sizes are provided for information only. The associated cross-sectional areas, in square brackets, have been rounded to show significant figures only. AWG refers to the American Wire Gage and the term "cmil" refers to circular mils where 1 cmil is the area of a circle having a diameter of 1 mil (one thousandth of an inch). These terms are commonly used to designate wire sizes in North America.

^a For RATED CURRENT up to 3 A, a nominal cross-sectional area of 0,5 mm² is permitted ☐ Text deleted ☐ provided that the length of the cord does not exceed 2 m.

^b The value in parentheses applies to DETACHABLE POWER SUPPLY CORDS fitted with the connectors rated 10 A in accordance with IEC 60320 (types C13, C15, C15A and C17) provided that the length of the cord does not exceed 2 m.

^c The value in parentheses applies to DETACHABLE POWER SUPPLY CORDS fitted with the connectors rated 16 A in accordance with IEC 60320 (types C19, C21 and C23) provided that the length of the cord does not exceed 2 m.

3.2.5.2 DC power supply cords

A power supply cord for connection to the DC MAINS SUPPLY shall be suitable for the voltage, current and the physical abuses it is likely to encounter.

Compliance is checked by inspection.

3.2.6 Cord anchorages and strain relief

For equipment with a NON-DETACHABLE POWER SUPPLY CORD, a cord anchorage shall be supplied such that

- the connecting points of the cord conductors are relieved from strain, and
- the outer covering of the cord is protected from abrasion.

It shall not be possible to push the cord back into the equipment to such an extent that the cord or its conductors, or both, could be damaged or internal parts of the equipment could be displaced.

For NON-DETACHABLE POWER SUPPLY CORDS containing a PROTECTIVE EARTHING CONDUCTOR, the construction shall be such that if the cord should slip in its anchorage, placing a strain on conductors, the PROTECTIVE EARTHING CONDUCTOR will be the last to take the strain.

The cord anchorage shall either be made of insulating material or have a lining of insulating material complying with the requirements for SUPPLEMENTARY INSULATION. However, where the cord anchorage is a bushing that includes the electrical connection to the screen of a screened power cord, this requirement shall not apply. The construction of the cord anchorage shall be such that:

- cord replacement does not impair the safety of the equipment; and
- for ordinary replacement cords, it is clear how relief from strain is to be obtained; and
- the cord is not clamped by a screw that bears directly on the cord, unless the cord anchorage, including the screw, is made of insulating material and the screw is of comparable size to the diameter of the cord being clamped; and
- methods such as tying the cord into a knot or tying the cord with string are not used; and
- the cord cannot rotate in relation to the BODY of the equipment to such an extent that mechanical strain is imposed on the electrical connections.

Compliance is checked by inspection and by applying the following tests that are made with the type of power supply cord supplied with the equipment.

The cord is subjected to a steady pull of the value shown in Table 3C, applied in the most unfavourable direction. The test is conducted 25 times, each time for a duration of 1 s.

During the tests, the power supply cord shall not be damaged. This is checked by visual inspection, and by an electric strength test between the power cord conductors and accessible conductive parts, at the test voltage appropriate for REINFORCED INSULATION.

After the tests, the power supply cord shall not have been longitudinally displaced by more than 2 mm nor shall there be appreciable strain at the connections, and CLEARANCES and CREEPAGE DISTANCES shall not be reduced below the values specified in 2.10 (or Annex G).

Table 3C – Physical tests on power supply cords

| Mass (M) of the equipment kg | Pull N |
|---------------------------------|-----------|
| Up to and including 1 | 30 |
| Over 1 up to and including 4 | 60 |
| Over 4 | 100 |

3.2.7 Protection against mechanical damage

Power supply cords shall not be exposed to sharp points or cutting edges within or on the surface of the equipment, or at the inlet opening or inlet bushing.

The overall sheath of a NON-DETACHABLE POWER SUPPLY CORD shall continue into the equipment through any inlet bushing or cord guard and shall extend by at least half the cord diameter beyond the clamp of the cord anchorage.

Inlet bushings, where used, shall

- be reliably fixed, and
- not be removable without the use of a TOOL.

A metallic inlet bushing shall not be used in a non-metallic ENCLOSURE.

An inlet bushing or cord guard secured to a conductive part that is not protectively earthed shall meet the requirements for SUPPLEMENTARY INSULATION.

Compliance is checked by inspection and measurement.

3.2.8 Cord guards

A cord guard shall be provided at the power supply cord inlet opening of equipment that has a NON-DETACHABLE POWER SUPPLY CORD, and which is HAND-HELD EQUIPMENT or is intended to be moved while in operation. Alternatively, the inlet or bushing shall be provided with a smoothly rounded bell-mouthed opening having a radius of curvature equal to at least 150 % of the overall diameter of the cord with the largest cross-sectional area to be connected.

Cord guards shall

- be so designed as to protect the cord against excessive bending where it enters the equipment,
- be of insulating material,
- be fixed in a reliable manner, and
- project outside the equipment beyond the inlet opening for a distance of at least five times the overall diameter or, for flat cords, at least five times the major overall cross-sectional dimension of the cord.

Compliance is checked by inspection, by measurement and, where necessary, by the following test with the cord as delivered with the equipment.

The equipment is so placed that the axis of the cord guard, where the cord leaves it, projects at an angle of 45° when the cord is free from stress. A mass equal to $10 \times D^2$ g is then attached to the free end of the cord, where D is the overall diameter of, or for flat cords, the minor overall dimension of the cord, in millimetres.

If the cord guard is of temperature-sensitive material, the test is made at $23 \text{ °C} \pm 2 \text{ °C}$.

Flat cords are bent in the plane of least resistance.

Immediately after the mass has been attached, the radius of curvature of the cord shall nowhere be less than $1,5 D$.

3.2.9 Supply wiring space

The supply wiring space provided inside, or as part of, the equipment for permanent connection or for connection of an ordinary NON-DETACHABLE POWER SUPPLY CORD shall be designed:

- to allow the conductors to be introduced and connected easily; and
- so that the uninsulated end of a conductor is unlikely to become free from its terminal, or, should it do so, cannot come into contact with:
 - an accessible conductive part that is not protectively earthed; or
 - an accessible conductive part of HAND-HELD EQUIPMENT; and
- to permit checking before fitting the cover, if any, that the conductors are correctly connected and positioned; and
- so that covers, if any, can be fitted without risk of damage to the supply conductors or their insulation; and
- so that covers, if any, giving access to the terminals can be removed with a commonly available TOOL.

Compliance is checked by inspection and by an installation test with cords of the largest cross-sectional area of the appropriate range specified in 3.3.4.

3.3 Wiring terminals for connection of external conductors

3.3.1 Wiring terminals

PERMANENTLY CONNECTED EQUIPMENT and equipment with ordinary NON-DETACHABLE POWER SUPPLY CORDS shall be provided with terminals in which connection is made by means of screws, nuts or equally effective devices (see also 2.6.4).

Compliance is checked by inspection.

3.3.2 Connection of non-detachable power supply cords

For equipment with special NON-DETACHABLE POWER SUPPLY CORDS, the connection of the individual conductors to the internal wiring of the equipment shall be accomplished by any means that will provide a reliable electrical and mechanical connection without exceeding the permitted temperature limits while the equipment is operated under NORMAL LOAD (see also 3.1.9).

Compliance is checked by inspection and by measuring the temperature of the connection which shall not exceed the values of 4.5.3, Table 4B.

3.3.3 Screw terminals

Screws and nuts that clamp external MAINS SUPPLY conductors shall have a thread conforming to ISO 261 or ISO 262, or a thread comparable in pitch and mechanical strength (for example, unified threads). The screws and nuts shall not serve to fix any other component, except that they are permitted also to clamp internal conductors provided that the internal conductors are so arranged that they are unlikely to be displaced when fitting the supply conductors. For protective earthing terminals and protective bonding terminals, see also 2.6.4.2.

The terminals of a component (for example, a switch) built into the equipment are permitted for use as terminals for external MAINS SUPPLY conductors, provided that they comply with the requirements of 3.3.

Compliance is checked by inspection.

3.3.4 Conductor sizes to be connected

Terminals shall allow the connection of conductors having nominal cross-sectional areas as shown in Table 3D.

Where heavier gauge conductors are used, the terminals shall be sized accordingly.

Compliance is checked by inspection, by measurement and by fitting cords of the smallest and largest cross-sectional areas of the appropriate range shown in Table 3D.

Table 3D – Range of conductor sizes to be accepted by terminals

| RATED CURRENT of equipment A | Nominal cross-sectional area mm ² | |
|----------------------------------|---|--------------|
| | Flexible cords | Other cables |
| Up to and including 3 | 0,5 to 0,75 | 1 to 2,5 |
| Over 3 up to and including 6 | 0,75 to 1 | 1 to 2,5 |
| Over 6 up to and including 10 | 1 to 1,5 | 1 to 2,5 |
| Ⓒ Over 10 up to and including 16 | 1,5 to 2,5 | 1,5 to 4 Ⓒ |
| Ⓒ Text deleted Ⓒ | | |
| Over 16 up to and including 25 | 2,5 to 4 | 2,5 to 6 |
| Over 25 up to and including 32 | 4 to 6 | 4 to 10 |
| Over 32 up to and including 40 | 6 to 10 | 6 to 16 |
| Over 40 up to and including 63 | 10 to 16 | 10 to 25 |

3.3.5 Wiring terminal sizes

Pillar, stud or screw type terminals shall comply with the minimum sizes in Table 3E.

Compliance is checked by inspection and measurement.

Table 3E – Sizes of terminals for mains supply conductors and protective earthing conductors ^a

| RATED CURRENT of equipment A | Minimum nominal thread diameter mm | |
|---------------------------------|---------------------------------------|-------------------------|
| | Pillar type or stud type | Screw type ^b |
| Up to and including 10 | 3,0 | 3,5 |
| Over 10 up to and including 16 | 3,5 | 4,0 |
| Over 16 up to and including 25 | 4,0 | 5,0 |
| Over 25 up to and including 32 | 4,0 | 5,0 |
| Over 32 up to and including 40 | 5,0 | 5,0 |
| Over 40 up to and including 63 | 6,0 | 6,0 |

^a This table is also used for the sizes of terminals for PROTECTIVE BONDING CONDUCTORS if specified in 2.6.4.2.

^b "Screw type" refers to a terminal that clamps the conductor under the head of a screw, with or without a washer.

3.3.6 Wiring terminal design

Wiring terminals shall be so designed that they clamp the conductor between metal surfaces with sufficient contact pressure and without damage to the conductor.

Terminals shall be so designed or located that the conductor cannot slip out when the clamping screws or nuts are tightened.

Terminals shall be provided with appropriate fixing hardware for the conductors (for example, nuts and washers).

Terminals shall be so fixed that, when the means of clamping the conductor is tightened or loosened, all of the following apply:

- the terminal itself does not work loose;
- internal wiring is not subjected to stress; and
- CLEARANCES and CREEPAGE DISTANCES are not reduced below the values specified in 2.10 (or Annex G).

Compliance is checked by inspection and measurement.

3.3.7 Grouping of wiring terminals

For ordinary NON-DETACHABLE POWER SUPPLY CORDS and for PERMANENTLY CONNECTED EQUIPMENT, all associated AC MAINS SUPPLY terminals shall be located in proximity to each other and to the main protective earthing terminal, if any.

For ordinary NON-DETACHABLE POWER SUPPLY CORDS and for PERMANENTLY CONNECTED EQUIPMENT, all associated DC MAINS SUPPLY terminals shall be located in proximity to each other. They need not be located in proximity to the main protective earthing terminal, if any, provided the installation instructions detail the proper earthing of the system.

Compliance is checked by inspection.

3.3.8 Stranded wire

The end of a stranded conductor shall not be consolidated by soft soldering at places where the conductor is subject to contact pressure unless the method of clamping is designed so as to reduce the likelihood of a bad contact due to cold flow of the solder.

Spring terminals that compensate for the cold flow are deemed to satisfy this requirement.

Preventing the clamping screws from rotating is not considered to be adequate.

Terminals shall be located, guarded or insulated so that, should a strand of a flexible conductor escape when the conductor is fitted, there is no likelihood of accidental contact between such a strand and

- accessible conductive parts, or
- unearthed conductive parts separated from accessible conductive parts by SUPPLEMENTARY INSULATION only.

Compliance is checked by inspection and, unless a special cord is prepared in such a way as to prevent the escape of strands, by the following test.

A piece of insulation approximately 8 mm long is removed from the end of a flexible conductor having the appropriate nominal cross-sectional area. One wire of the stranded conductor is left free and the other wires are fully inserted into, and clamped in the terminal.

Without tearing the insulation back, the free wire is bent in every possible direction, but without making sharp bends around the guard.

If the conductor is at HAZARDOUS VOLTAGE, the free wire shall not touch any conductive part that is accessible or is connected to an accessible conductive part or, in the case of DOUBLE INSULATED equipment, any conductive part that is separated from accessible conductive parts by SUPPLEMENTARY INSULATION only.

If the conductor is connected to an earthing terminal, the free wire shall not touch any part at HAZARDOUS VOLTAGE.

3.4 Disconnection from the mains supply

3.4.1 General requirement

A disconnect device or devices shall be provided to disconnect the equipment from the MAINS SUPPLY for servicing.

NOTE Instructions may be provided to allow servicing parts of the equipment with or without opening the disconnect device.

Compliance is checked by inspection.

3.4.2 Disconnect devices

For equipment intended to be powered from an AC MAINS SUPPLY that is Overvoltage Category I, Overvoltage Category II or Overvoltage Category III, or from a DC MAINS SUPPLY that is at a HAZARDOUS VOLTAGE, a disconnect device shall have a contact separation of at least 3 mm. For an AC MAINS SUPPLY that is Overvoltage Category IV, refer to IEC 60947-1.

For equipment intended to be powered from a DC MAINS SUPPLY that is not at a HAZARDOUS VOLTAGE, a disconnect device shall have a contact separation at least equal to the minimum CLEARANCE for BASIC INSULATION.

NOTE For a DC MAINS SUPPLY, additional measures may be necessary to prevent arcing in the disconnect device, depending on the circuit.

If a disconnect device is incorporated in the equipment, it shall be connected as closely as practicable to the incoming supply.

Functional switches are permitted as disconnect devices provided that they comply with all the requirements for disconnect devices. However, these requirements do not apply to functional switches where other means of isolation are provided.

The following types of disconnect devices are permitted:

- the MAINS SUPPLY plug on the power supply cord;
- a MAINS SUPPLY plug that is part of DIRECT PLUG-IN EQUIPMENT;
- an appliance coupler;
- an isolating switch;
- a circuit-breaker;
- for a DC MAINS SUPPLY that is not at a HAZARDOUS VOLTAGE, a removable fuse, provided that it is accessible only to a SERVICE PERSON;
- any equivalent device.

Compliance is checked by inspection.

3.4.3 Permanently connected equipment

For PERMANENTLY CONNECTED EQUIPMENT, the disconnect device shall be incorporated in the equipment, unless the equipment is accompanied by installation instructions in accordance with 1.7.2.1, stating that an appropriate disconnect device shall be provided external to the equipment.

NOTE External disconnect devices will not necessarily be supplied with the equipment.

Compliance is checked by inspection.

3.4.4 Parts which remain energized

Parts on the supply side of a disconnect device in the equipment which remain energized when the disconnect device is switched off shall be guarded so as to reduce the likelihood of accidental contact by a SERVICE PERSON.

Compliance is checked by inspection.

3.4.5 Switches in flexible cords

Isolating switches shall not be fitted in flexible cords.

Compliance is checked by inspection.

3.4.6 Number of poles - single-phase and d.c. equipment

A disconnect device, if provided in or as part of the equipment, shall disconnect both poles simultaneously, except that

- if it is possible to rely on the identification of the earthed conductor in the DC MAINS SUPPLY, or an earthed neutral in an AC MAINS SUPPLY, it is permitted to use a single-pole disconnect device that disconnects the unearthed (line) conductor, or
- if it is not possible to rely on the identification of the earthed conductor in the DC MAINS SUPPLY, or an earthed neutral in an AC MAINS SUPPLY, and the equipment is not provided with a two-pole disconnect device, the installation instructions shall specify that a two-pole disconnect device is to be provided external to the equipment.

NOTE Some examples of cases where a two-pole disconnect device is required (because identification of an earthed conductor in the MAINS SUPPLY is not possible) are:

- on equipment supplied from an IT power system;
- on PLUGGABLE EQUIPMENT supplied through a reversible appliance coupler or a reversible plug (unless the appliance coupler or plug itself is used as the disconnect device);
- on equipment supplied from a socket-outlet with unidentified or indeterminate polarity.

Compliance is checked by inspection.

3.4.7 Number of poles – three-phase equipment

For three-phase equipment, the disconnect device shall disconnect simultaneously all line conductors of the AC MAINS SUPPLY.

For equipment requiring a neutral connection to an IT power distribution system, the disconnect device shall be a four-pole device and shall disconnect all line conductors and the neutral conductor. If this four-pole device is not provided in the equipment, the installation instructions shall specify the need for the provision of the device external to the equipment.

If a disconnect device interrupts the neutral conductor, it shall simultaneously interrupt all line conductors.

Compliance is checked by inspection.

3.4.8 Switches as disconnect devices

Where the disconnect device is a switch incorporated in the equipment, its "ON" and "OFF" positions shall be marked in accordance with 1.7.8.

Compliance is checked by inspection.

3.4.9 Plugs as disconnect devices

Where a plug on the power supply cord is used as the disconnect device, the installation instructions shall comply with 1.7.2.1.

Compliance is checked by inspection.

3.4.10 Interconnected equipment

Where a group of units having individual supply connections is interconnected in such a way that it is possible for HAZARDOUS VOLTAGE or HAZARDOUS ENERGY LEVELS to be transmitted between units, a disconnect device shall be provided to disconnect hazardous parts likely to be contacted while the unit under consideration is being serviced, unless these parts are guarded and marked with appropriate warning labels. In addition a prominent label shall be provided on each unit giving adequate instructions for the removal of all such power from the unit.

Compliance is checked by inspection.

3.4.11 Multiple power sources

Where a unit receives power from more than one source (for example, different voltages or frequencies or as backup power), there shall be a prominent marking at each disconnect device giving adequate instructions for the removal of all power from the unit.

Compliance is checked by inspection.

3.5 Interconnection of equipment

3.5.1 General requirements

Where an equipment is intended to be electrically connected to another equipment, to an accessory or to a TELECOMMUNICATION NETWORK, interconnection circuits shall be selected to provide continued conformance to the requirements of 2.2 for SELV CIRCUITS, and with the requirements of 2.3 for TNV CIRCUITS, after making connections.

NOTE 1 This is normally achieved by connecting SELV CIRCUITS to SELV CIRCUITS, and TNV CIRCUITS to TNV CIRCUITS.

Additionally, SELV CIRCUITS of data ports for connection to other equipment or accessories shall limit the risk of fire in the connected equipment as specified in 3.5.4.

NOTE 2 It is permitted for an INTERCONNECTING CABLE to contain more than one type of circuit (for example, SELV CIRCUIT, LIMITED CURRENT CIRCUIT, TNV CIRCUIT, ELV CIRCUIT or HAZARDOUS VOLTAGE circuit) provided that they are separated as required by this standard.

Compliance is checked by inspection.

3.5.2 Types of interconnection circuits

Each interconnection circuit shall be one of the following types:

- an SELV CIRCUIT or a LIMITED CURRENT CIRCUIT; or
- a TNV-1 CIRCUIT, TNV-2 CIRCUIT or TNV-3 CIRCUIT; or
- a HAZARDOUS VOLTAGE circuit.

Except as permitted in 3.5.3, interconnection circuits shall not be ELV CIRCUITS.

Compliance is checked by inspection.

3.5.3 ELV circuits as interconnection circuits

Where additional equipment is specifically complementary to the host (first) equipment (for example, a collator for a copying machine) ELV CIRCUITS are permitted as interconnection circuits between the equipments, provided that the equipments continue to meet the requirements of this standard when connected together.

Compliance is checked by inspection.

3.5.4 Data ports for additional equipment

To limit the risk of fire in an additional equipment or accessory (for example, a scanner, mouse, keyboard, DVD drive, CD ROM drive or joystick), SELV CIRCUITS of a data port for connection of such equipment shall be supplied by a limited power source that complies with 2.5. This requirement does not apply if it is known that the additional equipment complies with 4.7.

NOTE It is recommended that manufacturers of accessories and their INTERCONNECTING CABLES include protection against fault currents up to 8 A at 100 VA, the maximum available from a limited power source in compliance with Table 2B.

Compliance is checked by inspection and, if necessary, by test.

4 Physical requirements

4.1 Stability

Under conditions of normal use, units and equipment shall not become physically unstable to the degree that they could become a hazard to an OPERATOR or to a SERVICE PERSON.

If units are designed to be fixed together on site and not used individually, the stability of each individual unit is exempt from the requirements of 4.1.

The requirements of 4.1 are not applicable if the installation instructions for a unit specify that the equipment is to be secured to the building structure before operation.

Under conditions of OPERATOR use, a stabilizing means, if needed, shall be automatic in operation when drawers, doors, etc., are opened.

During operations performed by a SERVICE PERSON, the stabilizing means, if needed, shall either be automatic in operation, or a marking shall be provided to instruct the SERVICE PERSON to deploy the stabilizing means.

Compliance is checked by the following tests, where relevant. Each test is conducted separately. During the tests, containers are to contain the amount of substance within their rated capacity producing the most disadvantageous condition. All castors and jacks, if used in normal operation, are placed in their most unfavourable position, with wheels and the like locked or blocked. However, if the castors are intended only to transport the unit, and if the installation instructions require jacks to be lowered after installation, then the jacks (and not the castors) are used in this test; the jacks are placed in their most unfavourable position, consistent with reasonable levelling of the unit.

- *A unit having a mass of 7 kg or more shall not fall over when tilted to an angle of 10° from its normal upright position. Doors, drawers, etc., are closed during this test. A unit provided with multi-positional features shall be tested in the least favourable position permitted by the construction.*

- *A floor-standing unit having a mass of 25 kg or more shall not fall over when a force equal to 20 % of the weight of the unit, but not more than 250 N, is applied in any direction except upwards, at a height not exceeding 2 m from the floor. Doors, drawers, etc., which may be moved for servicing by the OPERATOR or by a SERVICE PERSON, are placed in their most unfavourable position, consistent with the installation instructions.*
- *A floor-standing unit shall not fall over when a constant downward force of 800 N is applied at the point of maximum moment to any horizontal surface of at least 125 mm by at least 200 mm, at a height up to 1 m from the floor. Doors, drawers, etc., are closed during this test. The 800 N force is applied by means of a suitable test tool having a flat surface of approximately 125 mm by 200 mm. The downward force is applied with the complete flat surface of the test tool in contact with the EUT; the test tool need not be in full contact with uneven surfaces (for example, corrugated or curved surfaces).*

4.2 Mechanical strength

4.2.1 General

Equipment shall have adequate mechanical strength and shall be so constructed that no hazard is created in the meaning of this standard when subjected to handling as may be expected.

Mechanical strength tests are not required on an internal barrier, screen or the like, provided to meet the requirements of 4.6.2, if the ENCLOSURE provides mechanical protection.

A MECHANICAL ENCLOSURE shall be sufficiently complete to contain or deflect parts, which because of failure or for other reasons, might become loose, separated or thrown from a moving part.

NOTE Examples of equipment where such precautions may be necessary include CD-ROM or DVD drives whose rotational speed is greater than 8 000 r.p.m.

Compliance is checked by inspection of the construction and available data and, where necessary, by the relevant tests of 4.2.2 to 4.2.7 as specified.

The tests are not applied to handles, levers, knobs, the face of cathode ray tubes (see 4.2.8) or to transparent or translucent covers of indicating or measuring devices, unless parts at HAZARDOUS VOLTAGE are accessible by means of the test finger, Figure 2A (see 2.1.1.1), if the handle, lever, knob or cover is removed.

During the tests of 4.2.2, 4.2.3 and 4.2.4, earthed or unearthed conductive ENCLOSURES shall not bridge parts between which a HAZARDOUS ENERGY LEVEL exists and shall not contact a bare part at HAZARDOUS VOLTAGE. For voltages exceeding 1 000 V a.c. or 1 500 V d.c., contact is not permitted and there shall be an air gap between the part at HAZARDOUS VOLTAGE and the ENCLOSURE. This air gap shall either have a minimum length equal to the minimum CLEARANCE specified in 2.10.3 (or Annex G) for BASIC INSULATION or withstand the relevant electric strength test in 5.2.2.

After the tests of 4.2.2 to 4.2.7, the sample shall continue to comply with the requirements of 2.1.1, 2.6.1, 2.10, 3.2.6 and 4.4.1. It shall show no signs of interference with the operation of safety features such as THERMAL CUT-OUTS, overcurrent protection devices or interlocks. In case of doubt, SUPPLEMENTARY INSULATION or REINFORCED INSULATION is subjected to an electric strength test as specified in 5.2.2.

Damage to finish, cracks, dents and chips are disregarded if they do not adversely affect safety.

NOTE If a separate ENCLOSURE or part of an ENCLOSURE is used for a test, it may be necessary to reassemble such parts on the equipment in order to check compliance.

4.2.2 Steady force test, 10 N

Components and parts, other than parts serving as an ENCLOSURE (see 4.2.3 and 4.2.4), are subjected to a steady force of $10\text{ N} \pm 1\text{ N}$.

Compliance criteria are in 4.2.1.

4.2.3 Steady force test, 30 N

Parts of an ENCLOSURE located in an OPERATOR ACCESS AREA, which are protected by a cover or door meeting the requirements of 4.2.4, are subjected to a steady force of $30\text{ N} \pm 3\text{ N}$ for a period of 5 s, applied by means of a straight unjointed version of the test finger, Figure 2A (see 2.1.1.1), to the part on or within the equipment.

Compliance criteria are in 4.2.1.

4.2.4 Steady force test, 250 N

External ENCLOSURES are subjected to a steady force of $250\text{ N} \pm 10\text{ N}$ for a period of 5 s, applied in turn to the top, bottom and sides of the ENCLOSURE fitted to the equipment, by means of a suitable test tool providing contact over a circular plane surface 30 mm in diameter. However, this test is not applied to the bottom of an ENCLOSURE of equipment having a mass of more than 18 kg.

Compliance criteria are in 4.2.1.

4.2.5 Impact test

Except for equipment identified in 4.2.6, external surfaces of ENCLOSURES, the failure of which would give access to hazardous parts, are tested as follows.

A sample consisting of the complete ENCLOSURE, or a portion thereof representing the largest unreinforced area, is supported in its normal position. A solid smooth steel ball, approximately 50 mm in diameter and with a mass of $500\text{ g} \pm 25\text{ g}$, is permitted to fall freely from rest through a vertical distance (H) of 1,3 m (see Figure 4A) onto the sample. (Vertical surfaces are exempt from this test.)

In addition, the steel ball is suspended by a cord and swung as a pendulum in order to apply a horizontal impact, dropping through a vertical distance (H) of 1,3 m (see Figure 4A) onto the sample. (Horizontal surfaces are exempt from this test.) Alternatively, the sample is rotated 90° about each of its horizontal axes and the ball dropped as in the vertical impact test.

The bottoms of ENCLOSURES are also tested if the operating instructions permit an orientation in which the bottom of the ENCLOSURE becomes the top or a side of the ENCLOSURE.

The test is not applied to the following:

- a flat panel display;
- the face of a cathode ray tube (see 4.2.8);
- the platen glass of equipment (for example, on a copying machine);
- the surface of the ENCLOSURE of STATIONARY EQUIPMENT, including EQUIPMENT FOR BUILDING-IN, which is inaccessible and protected after installation.

Compliance criteria are in 4.2.1.

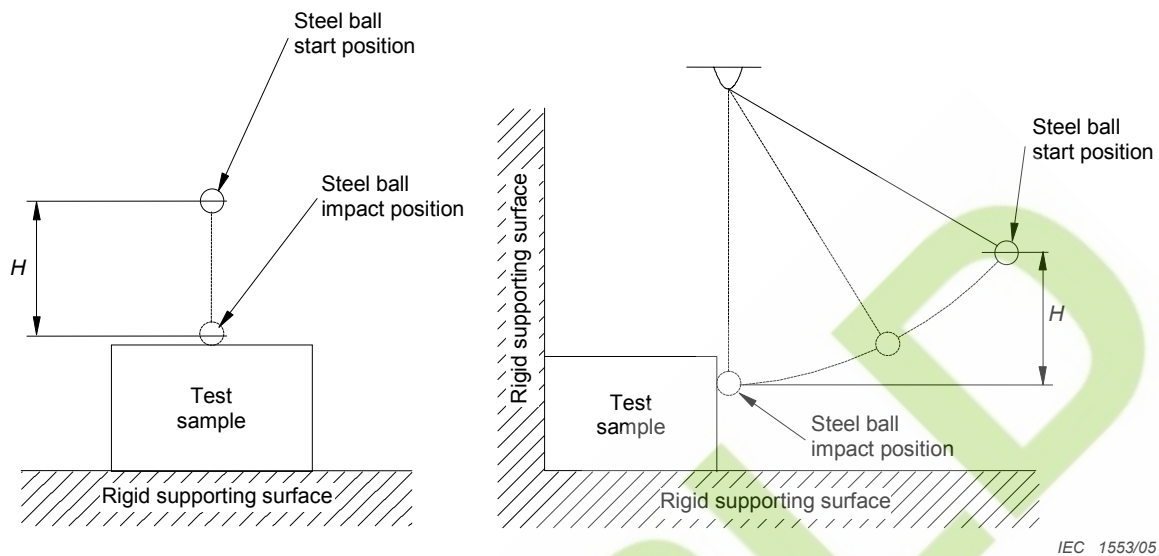

Figure 4A – Impact test using a steel ball

4.2.6 Drop test

The following equipment is subjected to a drop test:

- HAND-HELD EQUIPMENT;
- DIRECT PLUG-IN EQUIPMENT;
- TRANSPORTABLE EQUIPMENT;
- desk-top equipment having a mass of 5 kg or less that is intended for use with any one of the following:
 - a cord-connected telephone handset, or
 - another cord-connected hand-held accessory with an acoustic function, or
 - a headset;
- MOVABLE EQUIPMENT requiring lifting or handling by the USER as part of its intended use.

NOTE An example of such equipment is a paper shredder that rests on a waste container, requiring its removal to empty the container.

To determine compliance, a sample of the complete equipment is subjected to three impacts that result from being dropped onto a horizontal surface in positions likely to produce the most adverse results.

The height of the drop shall be:

- 750 mm ± 10 mm for desk-top equipment as described above;
- 750 mm ± 10 mm for MOVABLE EQUIPMENT as described above;
- 1 000 mm ± 10 mm for HAND-HELD EQUIPMENT, DIRECT PLUG-IN EQUIPMENT and TRANSPORTABLE EQUIPMENT.

The horizontal surface consists of hardwood at least 13 mm thick, mounted on two layers of plywood each 19 mm to 20 mm thick, all supported on a concrete or equivalent non-resilient floor.

Compliance criteria are in 4.2.1.

4.2.7 Stress relief test

ENCLOSURES of moulded or formed thermoplastic materials shall be so constructed that any shrinkage or distortion of the material due to release of internal stresses caused by the moulding or forming operation does not result in the exposure of hazardous parts or in the reduction of CLEARANCES or CREEPAGE DISTANCES below the values specified in 2.10 (or Annex G).

Compliance is checked by the test procedure described below or by the inspection of the construction and the available data where appropriate.

One sample consisting of the complete equipment, or of the complete ENCLOSURE together with any supporting framework, is placed in a circulating air oven (according to IEC 60216-4-1) at a temperature 10 K higher than the maximum temperature observed on the ENCLOSURE during the test of 4.5.2, but not less than 70 °C, for a period of 7 h, then permitted to cool to room temperature.

With the concurrence of the manufacturer, it is permitted to increase the above time duration.

For large equipment where it is impractical to condition a complete ENCLOSURE, it is permitted to use a portion of the ENCLOSURE representative of the complete assembly with regard to thickness and shape, including any mechanical support members.

NOTE Relative humidity need not be maintained at a specific value during this test.

If the above test is conducted, the compliance criteria of 4.2.1 apply.

4.2.8 Cathode ray tubes

If a cathode ray tube having a maximum face dimension exceeding 160 mm is included in the equipment, either the cathode ray tube or the ENCLOSURE with the cathode ray tube correctly installed shall comply with the requirements of Clause 18 of IEC 60065 for mechanical strength of cathode ray tubes.

NOTE Clause 18 of IEC 60065 requires cathode ray tubes either to pass the tests specified in 18.1 or to comply with IEC 61965. In the future amendment 2 to IEC 60065:2001, anticipated for 2006 at the earliest, it is intended that intrinsically-protected cathode ray tubes will be required to comply with IEC 61965, with no option as presently permitted in the seventh edition. The test now in 18.3 of IEC 60065 will continue to apply to non-intrinsically-protected tubes, which are not in the Scope of IEC 61965.

Compliance is checked by inspection, by measurement and, if necessary, by the relevant requirements and tests of Clause 18 of IEC 60065.

4.2.9 High pressure lamps

The MECHANICAL ENCLOSURE of a high pressure lamp shall have adequate strength to contain an explosion of the lamp so as to reduce the likelihood of harm to an OPERATOR or person near the equipment during normal use or OPERATOR servicing.

For the purpose of this standard, a "high pressure lamp" means one in which the pressure exceeds 0,2 MPa when cold or 0,4 MPa when operating.

Compliance is checked by inspection.

NOTE 2.10.3.5 may also apply in some cases.

4.2.10 Wall or ceiling mounted equipment

The mounting means of equipment intended for wall or ceiling mounting shall be adequate.

Compliance is checked by inspection of the construction and of available data, or where necessary, by the following test.

The equipment is mounted in accordance with the installation instructions. A force, in addition to the weight of the equipment, is applied downwards through the centre of gravity of the equipment, for 1 min. The additional force shall be equal to three times the weight of the equipment but not less than 50 N. The equipment and its associated mounting means shall remain secure during the test. After the test, the equipment, including any associated mounting plate, shall not be damaged.

4.3 Design and construction

4.3.1 Edges and corners

Where edges or corners could be hazardous to OPERATORS because of location or application in the equipment, they shall be rounded or smoothed.

This requirement does not apply to edges or corners that are required for proper functioning of the equipment.

Compliance is checked by inspection.

4.3.2 Handles and manual controls

Handles, knobs, grips, levers and the like shall be reliably fixed so that they will not work loose in normal use, if this might create a hazard. Sealing compounds and the like, other than self-hardening resins, shall not be used to prevent loosening.

If handles, knobs and the like are used to indicate the position of switches or similar components, it shall not be possible to fix them in a wrong position if this might create a hazard.

Compliance is checked by inspection, by manual test and by trying to remove the handle, knob, grip or lever by applying for 1 min an axial force as follows.

If the shape of these parts is such that an axial pull is unlikely to be applied in normal use, the force is:

- 15 N for the operating means of electrical components; and
- 20 N in other cases.

If the shape is such that an axial pull is likely to be applied, the force is:

- 30 N for the operating means of electrical components; and
- 50 N in other cases.

4.3.3 Adjustable controls

Equipment shall be so constructed that manual adjustment of a control device, such as a device for selection of different AC MAINS SUPPLY voltages, requires the use of a TOOL if incorrect setting or inadvertent adjustment might create a hazard.

NOTE Marking requirements for supply voltage adjustment are in 1.7.4.

Compliance is checked by manual test.

4.3.4 Securing of parts

Screws, nuts, washers, springs or similar parts shall be secured so as to withstand mechanical stresses occurring in normal use if loosening would create a hazard, or if CLEARANCES or CREEPAGE DISTANCES for SUPPLEMENTARY INSULATION or REINFORCED INSULATION would be reduced below the values specified in 2.10 (or Annex G).

NOTE 1 Requirements regarding fixing of conductors are in 3.1.9.

Compliance is checked by inspection, by measurement and by manual test.

For the purpose of assessing compliance:

- *it is assumed that two independent fixings will not become loose at the same time; and*
- *it is assumed that parts fixed by means of screws or nuts provided with self-locking washers or other means of locking are not liable to become loose.*

NOTE 2 Spring washers and the like can provide satisfactory locking.

4.3.5 Connection by plugs and sockets

Within a manufacturer's unit or system, plugs and sockets likely to be used by the OPERATOR or by a SERVICE PERSON shall not be employed in a manner likely to create a hazard due to misconnection. In particular, connectors complying with IEC 60083 or IEC 60320 shall not be used for SELV CIRCUITS or TNV CIRCUITS. Keying, location or, in the case of connectors accessible only to a SERVICE PERSON, clear markings are permitted to meet the requirement.

Compliance is checked by inspection.

4.3.6 Direct plug-in equipment

DIRECT PLUG-IN EQUIPMENT shall not impose undue stress on the socket-outlet. The mains plug part shall comply with the standard for the relevant mains plug.

Compliance is checked by inspection and, if necessary, by the following test.

The equipment is inserted, as in normal use, into a fixed socket-outlet of a configuration as intended by the manufacturer, which can be pivoted about a horizontal axis intersecting the centre lines of the contacts at a distance of 8 mm behind the engagement face of the socket-outlet. The additional torque that has to be applied to the socket-outlet to maintain the engagement face in the vertical plane shall not exceed 0,25 N · m.

Ⓒ Notes deleted Ⓒ

4.3.7 Heating elements in earthed equipment

Heating elements in equipment that is earthed for safety purposes shall be protected so that, under earth fault conditions, a fire hazard due to overheating is prevented. In such equipment, temperature sensing devices, if provided, shall be located in all line conductors supplying the heating elements.

The temperature sensing devices shall also disconnect the neutral conductor for each of the following cases:

- a) in equipment supplied from an IT power distribution system;
- b) in PLUGGABLE EQUIPMENT supplied through a reversible appliance coupler or a reversible plug;
- c) in equipment supplied from a socket-outlet with indeterminate polarity.

In cases b) and c), it is permitted to meet this requirement by connecting a THERMOSTAT in one conductor and a THERMAL CUT-OUT in the other conductor.

It is not required to disconnect the conductors simultaneously.

Compliance is checked by inspection.

4.3.8 Batteries

NOTE 1 Requirements for markings or instructions are given in 1.7.13.

NOTE 2 Requirements for overcurrent protection are given in 3.1.1 and 5.3.1.

NOTE 3 Requirements for stationary batteries (such as large secondary batteries installed in a fixed installation and external to the equipment) are given in IEC 60896-21, IEC 60896-22 and EN 50272-2.

Equipment containing batteries shall be designed to reduce the risk of fire, explosion and chemical leaks under normal conditions and after a single fault in the equipment (see 1.4.14), including a fault in circuitry within the equipment battery pack. For USER-replaceable batteries, the design shall reduce the likelihood of reverse polarity installation if this would create a hazard.

Battery circuits shall be designed so that:

- the output characteristics of a battery charging circuit are compatible with its rechargeable battery; and
- for non-rechargeable batteries, discharging at a rate exceeding the battery manufacturer's recommendations, and unintentional charging, are prevented; and
- for rechargeable batteries, charging and discharging at a rate exceeding the battery manufacturer's recommendations, and reversed charging, are prevented; and
- OPERATOR-replaceable batteries shall either:
 - have contacts that cannot be shorted with the test finger Figure 2A; or
 - be inherently protected to avoid creating a hazard within the meaning of the standard.

NOTE 4 Reverse charging of a rechargeable battery occurs when the polarity of the charging circuit is reversed, aiding the discharge of the battery.

If a battery contains liquid or gel electrolyte, a battery tray shall be provided that is capable of retaining any liquid that could leak as a result of internal pressure build-up in the battery. The requirement to provide a battery tray does not apply if the construction of the battery is such that leakage of the electrolyte from the battery is unlikely (see also 1.3.6).

NOTE 5 An example of a battery construction where leakage of the electrolyte is considered to be unlikely is the sealed cell valve-regulated type.

If a battery tray is required, its capacity shall be at least equal to the volume of electrolyte of all the cells of the battery, or the volume of a single cell if the design of the battery is such that simultaneous leakage from multiple cells is unlikely.

NOTE 6 If several cells (for example, the six cells in a 12 V lead-acid battery) are in a single casing, its fracture could lead to a greater volume of leakage than from a single cell.

Compliance is checked by inspection and by evaluation of the data provided by the equipment manufacturer and battery manufacturer.

When appropriate data is not available, compliance is checked by test. However, batteries that are inherently safe for the conditions given are not tested under those conditions. Consumer grade, non-rechargeable carbon-zinc or alkaline batteries are considered safe under short-circuiting conditions and therefore are not tested for discharge; nor are such batteries tested for leakage under storage conditions.

The battery used for the following tests is either a new non-rechargeable battery or a fully charged rechargeable battery as provided with, or recommended by the manufacturer for use with, the equipment.

- **Overcharging of a rechargeable battery.** *The battery is charged under each of the following conditions in turn.*
 - *The battery charging circuit is adjusted with the battery disconnected to give 106 % of the rated output voltage of the charger, or the maximum charging voltage available from the charger (without simulation of faults), whichever is the higher attainable value. The battery is then charged for 7 h.*
 - *The battery charging circuit is adjusted, with the battery disconnected, to 100 % of the rated output voltage of the charger. The battery is charged while briefly subjected to the simulation of any single component failure that is likely to occur in the charging circuit and that results in overcharging of the battery. To minimize testing time, the failure is chosen that causes the highest overcharging current. The battery is then charged for a single period of 7 h with that simulated failure in place.*
- **Unintentional charging of a non-rechargeable battery.** *The battery is charged while briefly subjected to the simulation of any single component failure that is likely to occur in the charging circuit and that would result in unintentional charging of the battery. To minimize testing time, the failure is chosen that causes the highest charging current. The battery is then charged for a single period of 7 h with that simulated failure in place.*
- **Reverse charging of a rechargeable battery.** *The battery is reverse charged while briefly subjected to the simulation of any single component failure that is likely to occur in the charging circuit and that would result in reverse charging of the battery. To minimize testing time, the failure is chosen that causes the highest reverse charging current. The battery is then reverse charged for a single period of 7 h with that simulated failure in place.*

- **Excessive discharging rate for any battery.** *The battery is subjected to rapid discharge by open-circuiting or short-circuiting any current-limiting or voltage-limiting components in the load circuit of the battery under test.*

NOTE 7 Some of the tests specified can be hazardous to the persons carrying them out; all appropriate measures to protect personnel against possible chemical or explosion hazards should be taken.

These tests shall not result in any of the following:

- *chemical leaks caused by cracking, rupturing or bursting of the battery jacket, if such leakage could adversely affect required insulation; or*
- *spillage of liquid from any pressure relief device in the battery, unless such spillage is contained by the equipment without risk of damage to the insulation or harm to the USER; or*
- *explosion of the battery, if such explosion could result in injury to a USER; or*
- *emission of flame or expulsion of molten metal to the outside of the equipment ENCLOSURE.*

After completion of the tests, the equipment is subjected to the electric strength tests of 5.3.9.2.

4.3.9 Oil and grease

Where internal wiring, windings, commutators, slip-rings and the like, and insulation in general, are exposed to oil, grease or similar substances, the insulation shall have adequate properties to resist deterioration under these conditions.

Compliance is checked by inspection, and by evaluation of the data for the insulating material.

4.3.10 Dust, powders, liquids and gases

Equipment producing dust (for example, paper dust) or using powders, liquids or gases shall be so constructed that it is unlikely that either a dangerous concentration of these materials or a hazard in the meaning of this standard will be created by condensation, vaporization, leakage, spillage or corrosion during normal operation, storage, filling or emptying. CLEARANCES and CREEPAGE DISTANCES shall not be reduced below the values specified in 2.10 (or Annex G).

Compliance is checked by inspection, measurement and, where spillage of liquid could affect electrical insulation during replenishment, by the following test and, for flammable liquids, by the tests of 4.3.12.

The equipment shall be ready to use according to its installation instructions, but not energized.

The liquid container of the equipment is completely filled with the liquid specified by the manufacturer and a further quantity, equal to 15 % of the capacity of the container is poured in steadily over a period of 1 min. For liquid containers having a capacity not exceeding 250 ml, and for containers without drainage and for which the filling cannot be observed from outside, a further quantity of liquid, equal to the capacity of the container, is poured in steadily over a period of 1 min.

Immediately after this treatment, the equipment shall withstand an electric strength test as specified in 5.2.2 on any insulation on which spillage could have occurred and inspection shall show that the liquid has not created a hazard in the meaning of this standard.

The equipment is permitted to stand in normal test-room atmosphere for 24 h before being subjected to any further electrical test.

4.3.11 Containers for liquids or gases

Equipment that, in normal use, contains liquids or gases shall incorporate adequate safeguards against build-up of excessive pressure.

Compliance is checked by inspection and, if necessary, by an appropriate test.

4.3.12 Flammable liquids

If a flammable liquid is used in equipment, the liquid shall be kept in a closed reservoir, except for the amount needed for the functioning of the equipment. The maximum quantity of flammable liquid stored in an equipment shall in general be not more than 5 l. If, however, the usage of liquid is such that more than 5 l is consumed in 8 h, it is permitted to increase the quantity stored to that required for an 8 h operation.

Oil or equivalent liquids used for lubrication or in a hydraulic system shall have a flash point of 149 °C or higher, and the reservoir shall be of sealed construction. The system shall have provision for expansion of the liquid and shall incorporate means for pressure relief. This requirement is not applicable to lubricating oils that are applied to points of friction in quantities that would contribute negligible fuel to a fire.

Except under conditions given below, replenishable liquids such as printing inks shall have a flash point of 60 °C or higher, and shall not be under sufficient pressure to cause atomization.

Replenishable flammable liquids that have a flash point of less than 60 °C or that are under sufficient pressure to cause atomization are permitted provided inspection shows that there is no likelihood of liquid sprays or build-up of flammable vapour-air mixtures that could cause explosion or create a fire hazard. Under normal operating conditions, equipment using a flammable liquid shall not generate a mixture with a concentration exceeding one quarter of the EXPLOSION LIMIT if the mixture is in proximity to an ignition source, or exceeding half the EXPLOSION LIMIT if the mixture is not in proximity to an ignition source. The investigation shall also take into account the integrity of the liquid handling system. The liquid handling system shall be suitably housed or constructed so that risk of fire or explosion is reduced, even under the test conditions specified in 4.2.5.

Compliance is checked by inspection and, where necessary, by the following test.

The equipment is operated in accordance with 4.5.2 until its temperature stabilizes. In this condition, the equipment is operated in a normal manner, as directed in the operating instructions, and samples of the atmosphere in the vicinity of the electrical components and around the equipment are taken to determine the concentration of flammable vapours present.

Samples of the atmosphere are taken at 4 min intervals; four samples to be taken during normal operation, then seven samples after the equipment has stopped.

If, after the equipment has stopped, the concentration of flammable vapours appears to be increasing, samples shall continue to be taken at 4 min intervals until the concentration is shown to be decreasing.

If an abnormal operation of the equipment is possible with any of its fans not running, this condition is simulated during this compliance test.

4.3.13 Radiation

4.3.13.1 General

Equipment shall be so designed that the risk of harmful effects of radiation to persons, and damage to materials affecting safety, is reduced.

Compliance is checked by inspection and as detailed in 4.3.13.2, 4.3.13.3, 4.3.13.4, 4.3.13.5 and 4.3.13.6 as appropriate.

4.3.13.2 Ionizing radiation

For equipment that generates ionizing radiation, compliance is checked by the test in Annex H.

4.3.13.3 Effect of ultraviolet (UV) radiation on materials

The following requirements apply only to equipment containing lamps that produce significant UV radiation, that is, having emission predominantly in the spectrum 180 nm to 400 nm, as specified by the lamp manufacturer.

NOTE General-purpose incandescent and fluorescent lamps, with ordinary glass envelopes, are not considered to emit significant UV radiation.

Non-metallic parts (for example, non-metallic ENCLOSURES and internal materials including wire and cable insulation) that are exposed to UV radiation from a lamp in the equipment, shall be sufficiently resistant to degradation to the extent that safety is not affected.

Table 4A – Minimum property retention limits after UV exposure

| Parts to be tested | Property | Standard for the test method | Minimum retention after test |
|---|---|------------------------------|------------------------------|
| Parts providing mechanical support | Tensile strength ^a | ISO 527 | 70 % |
| | or Flexural strength ^{a b} | ISO 178 | 70 % |
| Parts providing impact resistance | Charpy impact ^c or Izod impact ^c or Tensile impact ^c | ISO 179 | 70 % |
| | | ISO 180 | 70 % |
| | | ISO 8256 | 70 % |
| All parts | Flammability classification | See 1.2.12 and Annex A | See ^d |
| ^a Tensile strength and flexural strength tests are to be conducted on specimens no thicker than the actual thicknesses. ^b The side of the sample exposed to UV radiation is to be in contact with the two loading points when using the three point loading method. ^c Tests conducted on 3,0 mm thick specimens for Izod impact and Tensile impact tests and 4,0 mm thick specimens for Charpy impact tests are considered representative of other thicknesses, down to 0,8 mm. ^d The flammability classification may change as long as it does not fall below that specified in Clause 4. | | | |

Compliance is checked by examination of the construction and of available data regarding the UV resistance characteristics of the parts exposed to UV radiation in the equipment. If such data is not available, the tests in Table 4A are conducted on the parts.

Samples taken from the parts, or consisting of identical material, are prepared according to the standard for the test to be conducted. They are then conditioned according to Annex Y. After conditioning, the samples shall show no signs of significant deterioration, such as crazing or cracking. They are then kept at room ambient conditions for not less than 16 h and not more than 96 h, after which they are tested according to the standard for the relevant test.

In order to evaluate the percent retention of properties after test, samples that have not been conditioned according to Annex Y are tested at the same time as the conditioned samples. The retention shall be as specified in Table 4A.

4.3.13.4 Human exposure to ultraviolet (UV) radiation

The following requirements apply only to equipment containing lamps that produce significant UV radiation, that is having emission predominantly in the spectrum 180 nm to 400 nm as specified by the lamp manufacturer.

NOTE 1 General purpose incandescent and fluorescent lamps, with ordinary glass envelopes, are not considered to emit significant UV radiation.

Equipment shall not emit excessive UV radiation.

UV radiation shall either

- be adequately contained by the ENCLOSURE of the UV lamp or the ENCLOSURE of the equipment, or
- not exceed the relevant limits given in IEC 60825-9.

During normal operation, the relevant limit is that for 8 h exposure.

Higher limits are permitted for limited periods of time for maintenance and cleaning operations, if it is necessary for the UV lamp to be on during these operations. The relevant limits are those for the expected time intervals for these operations, which shall be stated in the USER and servicing instructions.

All USER access doors and covers that, if opened, would allow access to higher emissions than those permitted above shall be marked with one of the following (see also 1.7.12):

- "WARNING: TURN OFF THE UV LAMP BEFORE OPENING", or equivalent; or

- the symbol  or equivalent.

It is permitted for the above marking to be beside a door or cover, or on a door provided that the door is secured to the equipment.

The above marking is not required for a door or cover that is provided with a SAFETY INTERLOCK switch (see 2.8) that disconnects power to the UV lamp when the door or cover is opened, or any other mechanism that prevents UV radiation.

If the UV radiation symbol is used on the equipment, both the symbol and a warning similar to the above marking shall appear together in the USER and servicing instructions.

If higher emissions than those permitted above are accessible in a SERVICE ACCESS AREA, and it is necessary for the equipment to remain energized while being serviced, the equipment shall be marked with one of the following:

- "WARNING: USE UV RADIATION EYE AND SKIN PROTECTION DURING SERVICING", or equivalent; or



- the symbol or equivalent.

The marking shall be located where readily visible during the servicing operation (see also 1.7.12).

If the UV radiation symbol is used on the equipment, both the symbol and a warning similar to the above marking shall appear together in the servicing instructions.

Compliance is checked by inspection and, if necessary, by measurement.

UV radiation is measured using a scanning spectrograph or a specific detector having a spectral response equal to the relative spectral effectiveness for the UV range.

The UV radiation exposure and effective irradiance during normal operation shall not exceed the limits given in IEC 60825-9 for an 8 h exposure.

The UV radiation exposure and effective irradiance during maintenance and cleaning operations shall not exceed the limits in IEC 60825-9 corresponding to the exposure times stated for these operations in the relevant instructions. The maximum permitted radiation is that for 30 min exposure.

NOTE 2 The permitted radiation is increased as the exposure time is reduced.

All USER access doors and covers, and parts such as lenses, filters and the like, if their opening or removal could result in an increase in the UV radiation, shall be opened or removed during measurements, unless provided with a SAFETY INTERLOCK switch that disconnects the power to the UV lamp, or any other mechanism that prevents UV radiation.

NOTE 3 For guidance on measuring techniques, see CIE Publication 63.

4.3.13.5 Lasers (including LEDs)

Except as permitted below, equipment shall be classified and labelled according to IEC 60825-1, IEC 60825-2 and IEC 60825-12, as applicable.

Equipment that is inherently a Class I laser product, that is the equipment contains no laser or light emitting diode (LED) of a higher class number, is not required to have a laser warning label or other laser statement.

The data for laser or LED components shall confirm that these components comply with the Accessible Emission Limit for Class I when measured according to IEC 60825-1, for the above exception to apply. The data may be obtained from the component manufacturer (see 1.4.15) and can relate to the component alone or to the component in its intended application in the equipment. The lasers or LEDs shall produce radiation only in the wavelength range of 180 nm to 1 mm.

NOTE Some examples of applications of LEDs that will normally comply are those used as:

- indicating lights;
- infra-red devices such as are used in home entertainment devices;
- infra-red devices for data transmission such as are used between computers and computer peripherals;
- optocouplers; and
- other similar low power devices.

Compliance is checked by inspection, by evaluation of the data provided by the manufacturer and, if necessary, by testing according to IEC 60825-1.

4.3.13.6 Other types

For other types of radiation, compliance is checked by inspection.

NOTE Z1 Attention is drawn to 1999/519/EC: Council Recommendation on the limitation of exposure of the general public to electromagnetic fields 0 Hz to 300 GHz. Standards taking into account this Recommendation which demonstrate compliance with the applicable EU Directive are indicated in the OJEC.

4.4 Protection against hazardous moving parts

4.4.1 General

Hazardous moving parts of equipment, that is moving parts that have the potential to cause injury, shall be so arranged, enclosed or guarded as to reduce the risk of injury to persons.

AUTOMATIC RESET THERMAL CUT-OUTS or overcurrent protection devices, automatic timer starting, etc., shall not be incorporated if unexpected resetting might create a hazard.

Compliance is checked by inspection and as detailed in 4.4.2, 4.4.3 and 4.4.4.

4.4.2 Protection in operator access areas

In an OPERATOR ACCESS AREA, protection shall be provided by a suitable construction reducing the likelihood of access to hazardous moving parts, or by locating the moving parts in an ENCLOSURE provided with mechanical or electrical SAFETY INTERLOCKS that remove the hazard when access is gained.

Where it is not possible to comply fully with the above access requirements and also allow the equipment to function as intended, access is permitted provided that:

- the hazardous moving part concerned is directly involved in the process (for example, moving parts of a paper cutter); and
- the hazard associated with the part is obvious to the OPERATOR; and
- additional measures are taken as follows:
 - a statement shall be provided in the operating instructions and a marking shall be fixed to the equipment, each containing the following or a similar appropriate wording;

WARNING
HAZARDOUS MOVING PARTS
KEEP FINGERS AND OTHER BODY PARTS AWAY

- where the possibility exists that fingers, jewellery, clothing, etc., can be drawn into the moving parts, means shall be provided to enable the OPERATOR to stop the moving part.

The above warning notice and, where relevant, the means provided for stopping the moving part shall be placed in a prominent position, readily visible and accessible from the point where the risk of injury is greatest.

Compliance is checked by inspection and where necessary by a test with the test finger, Figure 2A (see 2.1.1.1), after removal of OPERATOR-detachable parts, and with OPERATOR access doors and covers open.

Unless additional measures have been taken as specified above, it shall not be possible to touch hazardous moving parts with the test finger, applied without appreciable force in every possible position.

Openings preventing the entry of the test finger, Figure 2A (see 2.1.1.1), are further tested by means of a straight unjointed version of the test finger applied with a force of 30 N. If the unjointed finger enters, the test with the test finger, Figure 2A (see 2.1.1.1), is repeated, except that the finger is pushed through the opening using any necessary force up to 30 N.

4.4.3 Protection in restricted access locations

For equipment to be installed in a RESTRICTED ACCESS LOCATION, the requirements and compliance criteria in 4.4.2 for OPERATOR ACCESS AREAS apply.

4.4.4 Protection in service access areas

In a SERVICE ACCESS AREA, protection shall be provided such that unintentional contact with hazardous moving parts is unlikely during servicing operations involving other parts of the equipment.

Compliance is checked by inspection.

4.5 Thermal requirements

4.5.1 General

Subclause 4.5 specifies requirements intended to prevent:

- touchable parts from exceeding certain temperatures; and
- components, parts, insulation and plastic materials from exceeding temperatures that may degrade electrical, mechanical, or other properties during normal use over the expected life of the equipment.

Consideration shall be given to the fact that, on a long-term basis, the electrical and mechanical properties of certain insulating materials (see 2.9.1) may be adversely affected (for example, by softeners evaporating at temperatures below the normal softening temperatures of the materials).

During the tests of 4.5.2, audio amplifiers are operated in accordance with 4.2.4 of IEC 60065.

4.5.2 Temperature tests

Materials used in components and in the construction of the equipment shall be selected so that under NORMAL LOAD, temperatures do not exceed safe values in the meaning of this standard.

Components working at high temperature shall be effectively shielded or separated to avoid overheating of their adjacent materials and components.

Compliance is checked by inspection of material data sheets and by determining and recording the temperatures. The equipment or parts of the equipment are operated in accordance with 1.4.5 under NORMAL LOAD until the temperature has stabilized. For temperature limits, see 4.5.3 and 4.5.4.

NOTE See also 1.4.4, 1.4.10, 1.4.12 and 1.4.13.

It is permitted to test components and other parts independently provided that the test conditions applicable to the equipment are followed.

Equipment intended for building-in or rack-mounting, or for incorporation in larger equipment, is tested under the most adverse actual or simulated conditions permitted in the installation instructions.

The temperature of electrical insulation (other than that of windings, see 1.4.13), the failure of which could create a hazard, is measured on the surface of the insulation at a point close to the heat source (see Footnote a in Table 4B). During the test:

- *THERMAL CUT-OUTS and overcurrent protection devices shall not operate;*
- *THERMOSTATS are permitted to operate, provided that they do not interrupt the normal operation of the equipment;*
- *TEMPERATURE LIMITERS are permitted to operate;*
- *sealing compounds, if any, shall not flow out.*

4.5.3 Temperature limits for materials

The temperature of materials and components shall not exceed the values shown in Table 4B.

Table 4B – Temperature limits, materials and components

| Part | Maximum temperature (T_{max}) °C |
|---|--|
| Insulation, including winding insulation: <ul style="list-style-type: none"> – of Class 105 material (A) – of Class 120 material (E) – of Class 130 material (B) – of Class 155 material (F) – of Class 180 material (H) – of Class 200 material – of Class 220 material – of Class 250 material | 100 ^{a b c} 115 ^{a b c} 120 ^{a b c} 140 ^{a b c} 165 ^{a b c} 180 ^{a b} 200 ^{a b} 225 ^{a b} |
| Rubber or PVC insulation of internal and external wiring, including power supply cords: <ul style="list-style-type: none"> – without temperature marking – with temperature marking | 75 ^d Temperature marking |
| Other thermoplastic insulation | See ^e |
| Terminals, including earthing terminals for external earthing conductors of STATIONARY EQUIPMENT, unless provided with a NON-DETACHABLE POWER SUPPLY CORD | 85 |
| Parts in contact with a flammable liquid | See 4.3.12 |
| Components | See 1.5.1 |
| <p>^a If the temperature of a winding is determined by thermocouples, these values are reduced by 10 °C, except in the case of</p> <ul style="list-style-type: none"> – a motor, or – a winding with embedded thermocouples. <p>^b For each material, account shall be taken of the data for that material to determine the appropriate maximum temperature.</p> <p>^c The designations A to H, formerly assigned in IEC 60085 to thermal classes 105 to 180, are given in parentheses.</p> <p>^d If there is no marking on the wire, the marking on the wire spool or the temperature rating assigned by the wire manufacturer is considered acceptable.</p> <p>^e It is not possible to specify maximum permitted temperatures for thermoplastic materials, due to their wide variety. These shall pass the tests specified in 4.5.5.</p> | |

4.5.4 Touch temperature limits

The temperatures of accessible parts in OPERATOR ACCESS AREAS shall not exceed the values shown in Table 4C.

Table 4C – Touch temperature limits

| Parts in OPERATOR ACCESS AREAS | Maximum temperature (T_{max}) °C | | |
|---|---|--|---------------------------------|
| | Metal | Glass, porcelain and vitreous material | Plastic and rubber ^b |
| Handles, knobs, grips, etc., held or touched for short periods only | 60 | 70 | 85 |
| Handles, knobs, grips, etc., continuously held in normal use | 55 | 65 | 75 |
| External surfaces of equipment that may be touched ^a | 70 | 80 | 95 |
| Parts inside the equipment that may be touched ^c | 70 | 80 | 95 |

^a Temperatures up to 100 °C are permitted on the following parts:

- areas on the external surface of equipment that have no dimension exceeding 50 mm, and that are not likely to be touched in normal use; and
- a part of equipment requiring heat for the intended function (for example, a document laminator), provided that this condition is obvious to the USER. A warning shall be marked on the equipment in a prominent position adjacent to the hot part.

The warning shall be either

- the symbol (IEC 60417-5041 (DB:2002-10)):



**WARNING
HOT SURFACE
DO NOT TOUCH**

- or the following or similar wording

^b For each material, account shall be taken of the data for that material to determine the appropriate maximum temperature.

^c Temperatures exceeding the limits are permitted provided that the following conditions are met:

- unintentional contact with such a part is unlikely; and
- the part has a marking indicating that this part is hot. It is permitted to use the following symbol (IEC 60417-5041 (DB:2002-10)) to provide this information.



For equipment intended for installation in a RESTRICTED ACCESS LOCATION, the temperature limits in Table 4C apply, except that for external metal parts that are evidently designed as heat sinks or that have a visible warning, a temperature of 90 °C is permitted.

4.5.5 Resistance to abnormal heat

Thermoplastic parts on which parts at HAZARDOUS VOLTAGE are directly mounted shall be resistant to abnormal heat.

Compliance is checked by subjecting the part to the ball pressure test according to IEC 60695-10-2. The test is not made if it is clear from examination of the physical characteristics of the material that it will meet the requirements of this test.

The test is made in a heating cabinet at a temperature of $(T - T_{amb} + T_{ma} + 15 \text{ °C}) \pm 2 \text{ °C}$.

However, a thermoplastic part supporting parts in a PRIMARY CIRCUIT is tested at a minimum of 125 °C.

The significances of T , T_{ma} and T_{amb} are as given in 1.4.12.1.

4.6 Openings in enclosures

NOTE 1 Subclauses 4.6.1 and 4.6.2 do not apply to TRANSPORTABLE EQUIPMENT. Subclause 4.6.4 applies to TRANSPORTABLE EQUIPMENT only.

NOTE 2 Additional requirements concerning openings in ENCLOSURES are in 2.1.1.

4.6.1 Top and side openings

For equipment that is intended to be used in more than one orientation (see 1.3.6), the requirements of 4.6.1 apply in each appropriate orientation.

Openings in the top and sides of ENCLOSURES, except for ENCLOSURES of TRANSPORTABLE EQUIPMENT (see 4.6.4), shall be so located or constructed that it is unlikely that objects will enter the openings and create hazards by contacting bare conductive parts.

NOTE 1 Hazards include energy hazards, and those created by bridging of insulation or by OPERATOR access to parts at HAZARDOUS VOLTAGE (for example, via metal jewellery).

Openings, located behind doors, panels, covers, etc., that can be opened or removed by an OPERATOR, are not required to comply provided that the equipment openings comply with the doors, panels and covers closed or in place.

Where a portion of the side of a FIRE ENCLOSURE falls within the area traced out by the 5° angle in Figure 4E, the limitations in 4.6.2 on sizes of openings in bottoms of FIRE ENCLOSURES also apply to this portion of the side.

Compliance is checked by inspection and measurement. Except for that portion of the side of a FIRE ENCLOSURE that is subject to the requirements of 4.6.2 (see above paragraph), any one of the following is considered to satisfy the requirements (other constructions are not excluded):

- *openings that do not exceed 5 mm in any dimension;*
- *openings that do not exceed 1 mm in width regardless of length;*
- *top openings in which vertical entry is prevented (see Figure 4B for examples);*
- *side openings provided with louvres that are shaped to deflect outwards an external vertically falling object (see Figure 4C for examples);*
- *top or side openings, as shown in Figure 4D, that are not located vertically, or within a volume V bounded by a 5° vertical projection up to the size of opening L, above bare conductive parts:*
 - *at HAZARDOUS VOLTAGE, or*
 - *that present an energy hazard within the meaning of 2.1.1.5.*

NOTE 2 The examples of Figures 4B, 4C, 4D and 4E are not intended to be used as engineering drawings but are only shown to illustrate the intent of these requirements.

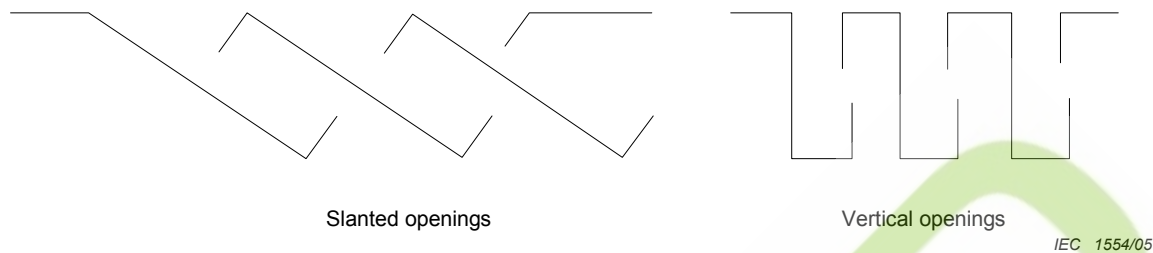

Figure 4B – Examples of cross-sections of designs of openings preventing vertical access

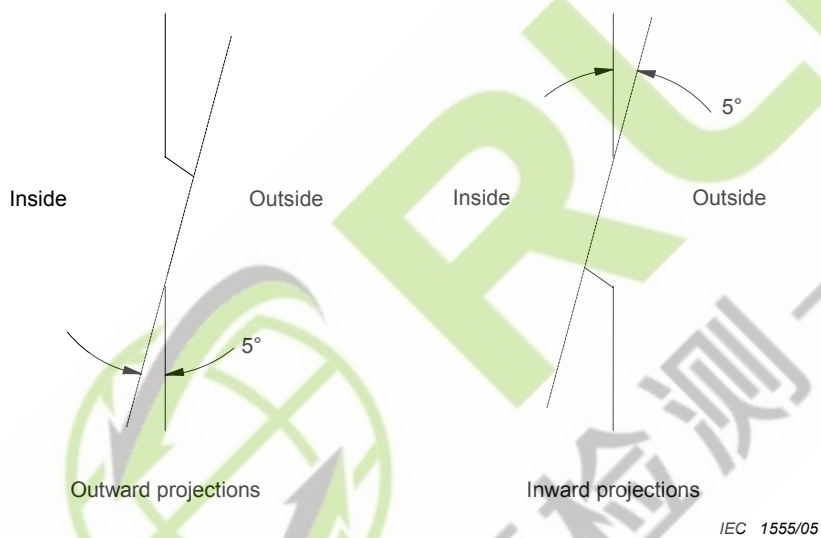
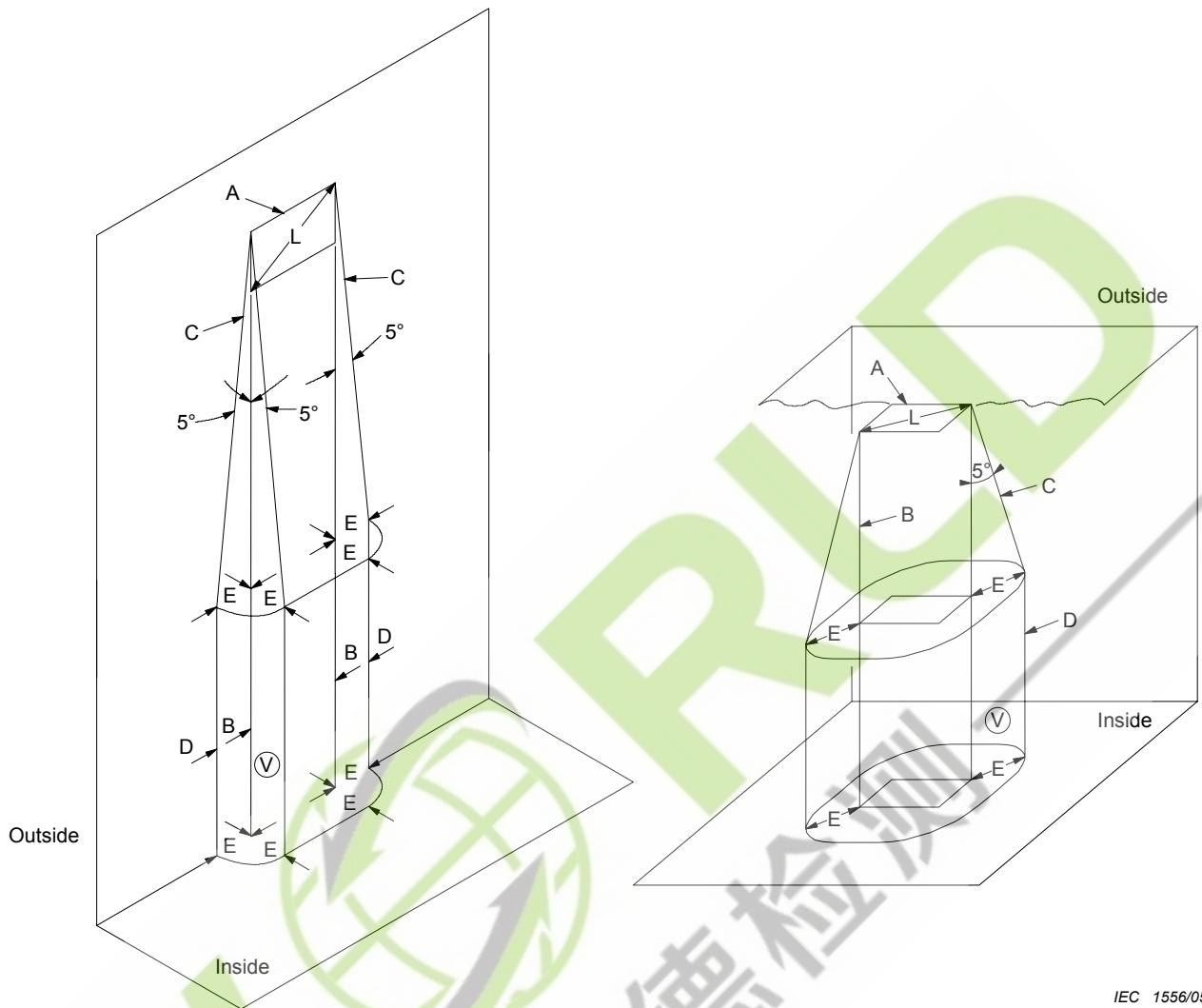

Figure 4C – Examples of louvre design



IEC 1556/05

- A ENCLOSURE opening.
- B Vertical projection of the outer edges of the opening.
- C Inclined lines that project at a 5° angle from the edges of the opening to points located E distance from B.
- D Line that is projected straight downward in the same plane as the ENCLOSURE side wall.
- E Projection of the outer edge of the opening (B) and the inclined line (C) (not to be greater than L).
- L Maximum dimension of the ENCLOSURE opening.
- V Volume in which bare parts at HAZARDOUS VOLTAGE, or which are energy hazards (see 4.6.1), are not located.

Figure 4D – Enclosure openings

4.6.2 Bottoms of fire enclosures

For equipment that is intended to be used in more than one orientation (see 1.3.6), the requirements of 4.6.2 apply in each appropriate orientation.

The bottom of a FIRE ENCLOSURE (except for the FIRE ENCLOSURE of a TRANSPORTABLE EQUIPMENT) or individual barriers, shall provide protection under all internal parts, including partially enclosed components or assemblies, which, under fault conditions, could emit material likely to ignite the supporting surface.

NOTE See 4.7.2.2 for parts that do not require a FIRE ENCLOSURE.

The bottom or barrier shall be located as, and no smaller in area than, indicated in Figure 4E and be horizontal, lipped or otherwise shaped to provide equivalent protection.

An opening in the bottom shall be protected by a baffle, screen or other means so that molten metal and burning material are unlikely to fall outside the FIRE ENCLOSURE.

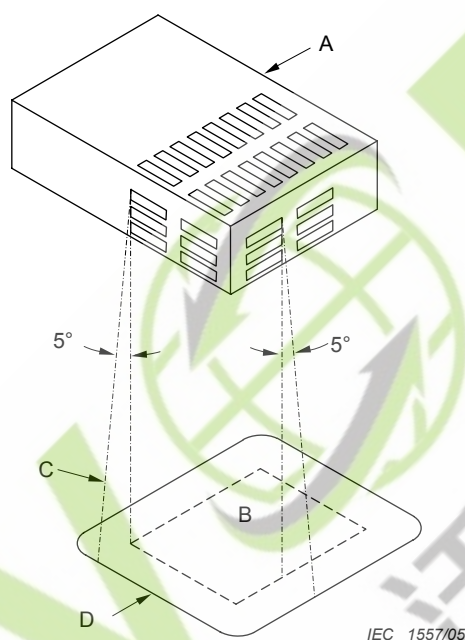

- A The portion of a component under which a FIRE ENCLOSURE is required, for example, under those openings in a component or assembly through which flaming particles might be emitted. If the component or assembly does not have its own FIRE ENCLOSURE, the area to be protected is the entire area occupied by the component or assembly.
- B The outline of the area of A projected vertically downward onto the horizontal plane of the lowest point of the FIRE ENCLOSURE.
- C Inclined line that traces an outline D on the same plane as B. Moving around the perimeter of the outline B, this line projects at a 5° angle from the vertical at every point round the perimeter of the openings in A and is oriented to trace out the largest area.
- D Minimum outline of the bottom of the FIRE ENCLOSURE. A portion of the side of a FIRE ENCLOSURE that is within the area traced out by the 5° angle is also considered to be part of the bottom of the FIRE ENCLOSURE.

Figure 4E – Typical bottom of a fire enclosure for partially enclosed component or assembly

The requirements of 4.6.2 do not apply to STATIONARY EQUIPMENT intended only for use in a RESTRICTED ACCESS LOCATION and to be mounted on a concrete floor or other non-combustible surface. Such equipment shall be marked as follows:

**SUITABLE FOR MOUNTING ON CONCRETE
OR OTHER NON-COMBUSTIBLE SURFACE ONLY**

Compliance is checked by inspection and, where necessary, by the test of Clause A.3.

The following constructions are considered to satisfy the requirement without test:

- no opening in the bottom of a FIRE ENCLOSURE;
- openings in the bottom of any size under an internal barrier, screen or the like, which itself complies with the requirements for a FIRE ENCLOSURE, see also 4.2.1;
- openings in the bottom, each not larger than 40 mm^2 , under components and parts meeting the requirements for V-1 CLASS MATERIAL, or HF-1 CLASS FOAMED MATERIAL or under small components that pass the needle-flame test of IEC 60695-11-5 using a 30 s flame application;
- baffle plate construction as illustrated in Figure 4F;
- metal bottoms of FIRE ENCLOSURES conforming to the dimensional limits of any line in Table 4D;
- metal bottom screens having a mesh with nominal openings not greater than 2 mm between centre lines and with wire diameters of not less than 0,45 mm.

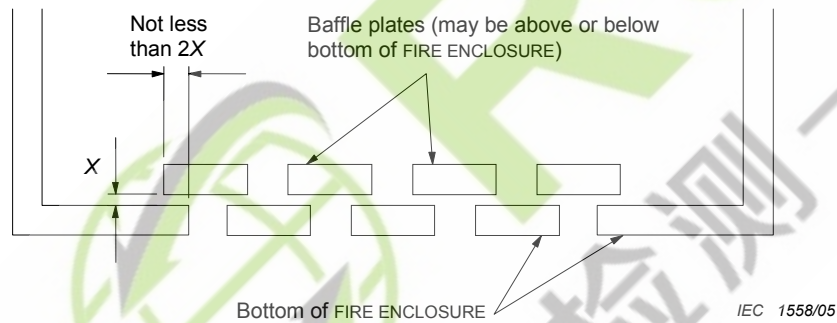

Figure 4F – Baffle plate construction

Table 4D – Size and spacing of openings in metal bottoms of fire enclosures

| Applicable to circular holes | | | Applicable to other shaped openings | |
|--------------------------------------|---------------------------------|---|-------------------------------------|--|
| Metal bottom minimum thickness mm | Maximum diameter of holes mm | Minimum spacing of holes centre to centre mm | Maximum area mm ² | Minimum spacing of openings border to border mm |
| 0,66 | 1,1 | 1,7 | 1,1 | 0,56 |
| 0,66 | 1,2 | 2,3 | 1,2 | 1,1 |
| 0,76 | 1,1 | 1,7 | 1,1 | 0,55 |
| 0,76 | 1,2 | 2,3 | 1,2 | 1,1 |
| 0,81 | 1,9 | 3,1 | 2,9 | 1,1 |
| 0,89 | 1,9 | 3,1 | 2,9 | 1,2 |
| 0,91 | 1,6 | 2,7 | 2,1 | 1,1 |
| 0,91 | 2,0 | 3,1 | 3,1 | 1,2 |
| 1,0 | 1,6 | 2,7 | 2,1 | 1,1 |
| 1,0 | 2,0 | 3,0 | 3,2 | 1,0 |

4.6.3 Doors or covers in fire enclosures

If part of a FIRE ENCLOSURE consists of a door or cover leading to an OPERATOR ACCESS AREA, it shall comply with one of the following requirements:

- the door or cover shall be interlocked to comply with the requirements in 2.8;
- a door or cover, intended to be routinely opened by the OPERATOR, shall comply with both of the following conditions:
 - it shall not be removable from other parts of the FIRE ENCLOSURE by the OPERATOR; and
 - it shall be provided with a means to keep it closed during normal operation;
- a door or cover intended only for occasional use by the OPERATOR, such as for the installation of accessories, is permitted to be removable provided that the operating instructions include directions for correct removal and reinstallation of the door or cover.

Compliance is checked by inspection.

4.6.4 Openings in transportable equipment

The risk of ignition caused by small metallic objects, such as paper clips or staples, moving around inside TRANSPORTABLE EQUIPMENT during transportation shall be reduced by measures to minimize the likelihood of such objects entering the equipment and bridging bare conductive parts that may result in a fire hazard. Except as required in 4.6.4.3, provision of such measures is not required for bare conductive parts between which the power is limited in accordance with 2.5.

NOTE The above requirement only applies to bare conductive parts. Conductive parts covered with conformal or other coatings are not considered to be bare conductive parts.

Compliance is checked according to 4.6.4.1, 4.6.4.2 and 4.6.4.3 as appropriate. During the inspection and tests, all doors or covers are closed or in place and peripheral devices or assemblies, such as disk drives, batteries, etc., are installed as intended.

4.6.4.1 Constructional design measures

Examples of acceptable constructional design measures are:

- providing openings that do not exceed 1 mm in width regardless of length; or
- providing a screen having a mesh with openings not greater than 2 mm between centre lines and constructed with a thread or wire diameter of not less than 0,45 mm; or
- providing internal barriers; or
- other equivalent constructional means.

NOTE Screens provided to limit the entry of small objects form part of the ENCLOSURE and the requirements in 4.7 for FIRE ENCLOSURES may apply, see also 1.3.6.

Compliance is checked by inspection and measurement and, if necessary, by simulating the entry of objects that could bridge bare conductive parts.

4.6.4.2 Evaluation measures for larger openings

Openings larger than specified in 4.6.4.1 are permitted (see also 2.1.1.1), provided that fault testing is conducted to simulate bridging along a direct straight path between bare conductive parts (for metallized parts, see 4.6.4.3) located less than 13 mm away from each other in all areas within the equipment that do not meet the criteria of 4.6.4.1.

Compliance is checked by inspection and measurement and by simulated fault testing. Bridging is considered to exist between bare conductive parts that can be contacted simultaneously using a straight metal object, 1 mm in diameter and having any length up to 13 mm, applied without appreciable force. During the fault tests, there shall be no ignition of any non-metallic materials and no emission of molten metal.

4.6.4.3 Use of metallized parts

Where metallized parts of a plastic barrier or ENCLOSURE are within 13 mm of parts of circuits where the available power is greater than 15 VA, one of the following requirements a) or b) or c) applies:

- a) access by a foreign metallic object shall be limited in accordance with 4.6.4.1, whether or not the available power meets the limits of 2.5; or
- b) there shall be a barrier between the bare conductive parts and the metallized barrier or ENCLOSURE; or
- c) fault testing shall be conducted to simulate bridging along a direct path between a bare conductive part and the nearest metallized part of a barrier or ENCLOSURE that is within 13 mm of the bare conductive part.

NOTE Examples of metallized plastic barriers or ENCLOSURES include those made of conductive composite materials or that are electroplated, vacuum-deposited, painted or foil lined.

Compliance is checked by inspection and measurement and, where appropriate, by test. If simulated fault testing is conducted, no ignition of the metallized barrier or ENCLOSURE shall occur.

4.6.5 Adhesives for constructional purposes

If a barrier or screen provided to comply with 4.6.1, 4.6.2 or 4.6.4 is secured with adhesive to the inside of the ENCLOSURE or to other parts inside the ENCLOSURE, the adhesive shall have adequate bonding properties throughout the life of the equipment.

Compliance is checked by examination of the construction and of the available data. If such data is not available, compliance is checked by the following tests.

A sample of the equipment or a part of the ENCLOSURE with the barrier or screen attached is evaluated with the sample placed with the barrier or screen on the underside.

Condition the sample in an oven at one of the following temperatures for the time durations specified:

- 100 °C ± 2 °C for one week; or*
- 90 °C ± 2 °C for three weeks; or*
- 82 °C ± 2 °C for eight weeks.*

Upon completion of the temperature conditioning, subject the sample to the following:

- remove the sample from oven and leave it at any convenient temperature between 20 °C and 30 °C for 1 h;*
- place the sample in a freezer at -40 °C ± 2 °C for 4 h;*
- remove and allow the sample to come to any convenient temperature between 20 °C and 30 °C for 8 h;*
- place the sample in a cabinet at 91 % to 95 % relative humidity for 72 h;*
- remove the sample and leave it at any convenient temperature between 20 °C and 30 °C for 1 h;*
- place the sample in an oven at the temperature used for the temperature conditioning for 4 h;*
- remove the sample and allow it to reach any convenient temperature between 20 °C; and 30 °C for 8 h.*

The sample is then immediately subjected to the tests of 4.2 as applicable. The barrier or screen shall not fall off or partly dislodge as a result of these tests.

With the concurrence of the manufacturer, it is permitted to increase any of the above time durations.

4.7 Resistance to fire

This subclause specifies requirements intended to reduce the risk of ignition and the spread of flame, both within the equipment and to the outside, by the appropriate use of materials and components and by suitable construction.

NOTE 1 The risk of ignition is reduced by limiting the maximum temperature of components under normal operating conditions and after a single fault (see 1.4.14), or by limiting the power available in a circuit.

NOTE 2 The spread of flame in the event of ignition is reduced by the use of flame retardant materials and insulation, or by providing adequate separation.

NOTE 3 For a ranking of materials with respect to flammability, refer to the notes in 1.2.12.1.

[C] Note deleted **[C]**

Metals, ceramic materials and glass shall be considered to comply without test.

4.7.1 Reducing the risk of ignition and spread of flame

For equipment or a portion of equipment, there are two alternative methods of providing protection against ignition and spread of flame that could affect materials, wiring, wound components and electronic components such as integrated circuits, transistors, thyristors, diodes, resistors and capacitors.

Method 1 – Selection and application of components, wiring and materials that reduce the possibility of ignition and spread of flame and, where necessary, by the use of a FIRE ENCLOSURE. The appropriate requirements are detailed in 4.7.2 and 4.7.3. In addition, the simulated faults of 5.3.7 are applied, except for 5.3.7 c), when using this method.

NOTE 1 Method 1 may be preferred for equipment or that portion of equipment with a large number of electronic components.

Method 2 – Application of all of the simulated fault tests in 5.3.7. A FIRE ENCLOSURE is not required for equipment or that portion of equipment for which only Method 2 is used. In particular, 5.3.7 c) applies, which includes testing all relevant components in both PRIMARY CIRCUITS and SECONDARY CIRCUITS.

NOTE 2 Method 2 may be preferred for equipment or that portion of equipment with a small number of electronic components.

4.7.2 Conditions for a fire enclosure

A FIRE ENCLOSURE is required when temperatures of parts under fault conditions could be sufficient for ignition.

4.7.2.1 Parts requiring a fire enclosure

Except where Method 2 of 4.7.1 is used, or as permitted in 4.7.2.2, the following are considered to have a risk of ignition and, therefore, require a FIRE ENCLOSURE:

- components in PRIMARY CIRCUITS;
- components in SECONDARY CIRCUITS supplied by power sources that exceed the limits specified in 2.5;
- components in SECONDARY CIRCUITS supplied by limited power sources as specified in 2.5, but not mounted on V-1 CLASS MATERIAL;
- components within a power supply unit or assembly having a limited power output as specified in 2.5, including overcurrent protective devices, limiting impedances, regulating networks and wiring, up to the point where the limited power source output criteria are met;
- components having unenclosed arcing parts, such as open switch and relay contacts and commutators, in a circuit at HAZARDOUS VOLTAGE or at a HAZARDOUS ENERGY LEVEL; and
- insulated wiring.

4.7.2.2 Parts not requiring a fire enclosure

The following do not require a FIRE ENCLOSURE:

- motors;
- transformers;
- electromechanical components complying with 5.3.5;
- wiring and cables insulated with PVC, TFE, PTFE, FEP, polychloroprene or polyimide;

- plugs and connectors forming part of a power supply cord or INTERCONNECTING CABLE;
- components, including connectors, meeting the requirements of 4.7.3.2, which fill an opening in a FIRE ENCLOSURE;
- connectors in SECONDARY CIRCUITS supplied by power sources that are limited to a maximum of 15 VA (see 1.4.11) under normal operating conditions and after a single fault in the equipment (see 1.4.14);
- connectors in SECONDARY CIRCUITS supplied by limited power sources complying with 2.5;
- other components in SECONDARY CIRCUITS:
 - supplied by limited power sources complying with 2.5 and mounted on V-1 CLASS MATERIAL;
 - supplied by internal or external power sources that are limited to a maximum of 15 VA (see 1.4.11) under normal operating conditions and after a single fault in the equipment (see 1.4.14) and mounted on HB75 CLASS MATERIAL, if the thinnest significant thickness of this material is < 3 mm, or HB40 CLASS MATERIAL, if the thinnest significant thickness of this material is ≥ 3 mm;

Ⓢ Note deleted Ⓢ

- complying with Method 2 of 4.7.1;
- equipment, or a part of the equipment, having a momentary contact switch that the USER has to activate continuously, and the release of which removes all power from the equipment or part.

Compliance with 4.7.2.1 and 4.7.2.2 is checked by inspection and by evaluation of the data provided by the manufacturer. In the case where no data is provided, compliance is determined by tests.

4.7.3 Materials

4.7.3.1 General

ENCLOSURES, components and other parts shall be so constructed, or shall make use of such materials, that the propagation of fire is limited.

VTM-0 CLASS MATERIAL, VTM-1 CLASS MATERIAL and VTM-2 CLASS MATERIAL are considered to be equivalent to V-0 CLASS MATERIAL, V-1 CLASS MATERIAL and V-2 CLASS MATERIAL, respectively, for their flammability properties. Their electrical and mechanical properties are not necessarily equivalent.

Where HB40 CLASS MATERIAL, HB75 CLASS MATERIAL or HBF CLASS FOAMED MATERIAL, is required, material passing the glow-wire test at 550 °C according to IEC 60695-2-11 is acceptable as an alternative.

Where it is not practical to protect components against overheating under fault conditions, the components shall be mounted on V-1 CLASS MATERIAL. Additionally, such components shall be separated from material of a class lower than V-1 CLASS MATERIAL (see 1.2.12.1, Note 2) by at least 13 mm of air, or by a solid barrier of V-1 CLASS MATERIAL.

NOTE 1 See also 4.7.3.5.

Ⓢ Note deleted Ⓢ

NOTE 3 In considering how to limit propagation of fire, and what are "small parts", account should be taken of the cumulative effect of small parts when they are adjacent to each other, and also of the possible effect of propagating fire from one part to another.

NOTE 4 The material flammability requirements in 4.7.3 are summarized in Table 4E.

Compliance is checked by inspection and by evaluation of relevant data provided by the manufacturer.

4.7.3.2 Materials for fire enclosures

The following requirements apply as appropriate.

The 18 kg mass criterion applies to individual complete equipments, even if they are used in close proximity to each other (for example, one on top of another). However, if a part of the FIRE ENCLOSURE is removed in such a situation (in the same example, the bottom cover of the top equipment), the combined mass of the equipment applies. In determining the total mass of equipment, supplies, consumable materials, media and recording materials used with the equipment shall not be taken into account.

For MOVABLE EQUIPMENT having a total mass not exceeding 18 kg, the material of a FIRE ENCLOSURE, in the thinnest significant wall thickness used, shall be of V-1 CLASS MATERIAL or shall pass the test of Clause A.2.

For MOVABLE EQUIPMENT having a total mass exceeding 18 kg and for all STATIONARY EQUIPMENT, the material of a FIRE ENCLOSURE, in the thinnest significant wall thickness used, shall be of 5VB CLASS MATERIAL or shall pass the test of Clause A.1.

Materials for components that fill an opening in a FIRE ENCLOSURE, and that are intended to be mounted in this opening shall:

- be of V-1 CLASS MATERIAL; or
- pass the tests of Clause A.2; or
- comply with the flammability requirements of the relevant IEC component standard.

NOTE Examples of these components are fuseholders, switches, pilot lights, connectors and appliance inlets.

Plastic materials of a FIRE ENCLOSURE shall be located more than 13 mm through air from arcing parts such as unenclosed commutators and unenclosed switch contacts.

Plastic materials of a FIRE ENCLOSURE located less than 13 mm through air from non-arcing parts which, under any condition of normal or abnormal operation, could attain a temperature sufficient to ignite the material, shall be capable of passing the test of IEC 60695-2-20. The average time to ignition of the samples shall be not less than 15 s. If a sample melts through without igniting, the time at which this occurs is not considered to be the time to ignition.

Compliance is checked by inspection of the equipment and material data sheets and, if necessary, by the appropriate test or tests in Annex A or IEC 60695-2-20.

4.7.3.3 Materials for components and other parts outside fire enclosures

Except as otherwise noted below, materials for components and other parts (including MECHANICAL ENCLOSURES, ELECTRICAL ENCLOSURES and DECORATIVE PARTS), located outside FIRE ENCLOSURES, shall be of

- HB75 CLASS MATERIAL if the thinnest significant thickness of this material is < 3 mm, or
- HB40 CLASS MATERIAL if the thinnest significant thickness of this material is ≥ 3 mm, or
- HBF CLASS FOAMED MATERIAL.

NOTE Where a MECHANICAL ENCLOSURE or an ELECTRICAL ENCLOSURE also serves as a FIRE ENCLOSURE, the requirements for FIRE ENCLOSURES apply.

Requirements for materials in air filter assemblies are in 4.7.3.5 and for materials in high-voltage components in 4.7.3.6.

Connectors shall comply with one of the following:

- be made of V-2 CLASS MATERIAL; or
- pass the tests of Clause A.2; or
- comply with the flammability requirements of the relevant IEC component standard; or
- be mounted on V-1 CLASS MATERIAL and be of a small size; or
- be located in a SECONDARY CIRCUIT supplied by a power source that is limited to a maximum of 15 VA (see 1.4.11) under normal operating conditions and after a single fault in the equipment (see 1.4.14).

The requirement for materials for components and other parts to be of HB40 CLASS MATERIAL, HB75 CLASS MATERIAL, or HBF CLASS FOAMED MATERIAL, does not apply to any of the following:

- electrical components that do not present a fire hazard under abnormal operating conditions when tested according to 5.3.7;
- materials and components within an ENCLOSURE of $0,06 \text{ m}^3$ or less, consisting totally of metal and having no ventilation openings, or within a sealed unit containing an inert gas;
- meter cases (if otherwise determined to be suitable for mounting of parts at HAZARDOUS VOLTAGE), meter faces and indicator lamps or their jewels;
- components meeting the flammability requirements of a relevant IEC component standard that includes such requirements;
- electronic components, such as integrated circuit packages, optocoupler packages, capacitors and other small parts that are:
 - mounted on V-1 CLASS MATERIAL; or
 - supplied from a power source of no more than 15 VA (see 1.4.11) under normal operating conditions or after a single fault in the equipment (see 1.4.14) and mounted on HB75 CLASS MATERIAL if the thinnest significant thickness of this material is < 3 mm, or HB40 CLASS MATERIAL if the thinnest significant thickness of this material is ≥ 3 mm;

- wiring, cables and connectors insulated with PVC, TFE, PTFE, FEP, polychloroprene or polyimide;
- individual clamps (not including helical wraps or other continuous forms), lacing tape, twine and cable ties used with wiring harnesses;
- gears, cams, belts, bearings and other small parts that would contribute negligible fuel to a fire, including DECORATIVE PARTS, labels, mounting feet, key caps, knobs and the like;
- supplies, consumable materials, media and recording materials;
- parts that are required to have particular properties in order to perform intended functions, such as rubber rollers for paper pick-up and delivery, and ink tubes.

Compliance is checked by inspection of the equipment and material data sheets and, if necessary, by the appropriate test or tests in Annex A.

4.7.3.4 Materials for components and other parts inside fire enclosures

Requirements for materials in air filter assemblies are in 4.7.3.5 and requirements for materials in high-voltage components in 4.7.3.6.

Inside FIRE ENCLOSURES, materials for components and other parts, (including MECHANICAL ENCLOSURES and ELECTRICAL ENCLOSURES located inside FIRE ENCLOSURES), shall comply with one of the following:

- be of V-2 CLASS MATERIAL or HF-2 CLASS FOAMED MATERIAL; or
- pass the flammability test described in Clause A.2; or
- meet the flammability requirements of a relevant IEC component standard that includes such requirements.

The above requirement does not apply to any of the following:

- electrical components that do not present a fire hazard under abnormal operating conditions when tested according to 5.3.7;
- materials and components within an ENCLOSURE of 0,06 m³ or less, consisting totally of metal and having no ventilation openings, or within a sealed unit containing an inert gas;
- one or more layers of thin insulating material, such as adhesive tape, used directly on any surface within a FIRE ENCLOSURE, including the surface of current-carrying parts, provided that the combination of the thin insulating material and the surface of application complies with the requirements of V-2 CLASS MATERIAL, or HF-2 CLASS FOAMED MATERIAL;

NOTE Where the thin insulating material referred to in the above exclusion is on the inner surface of the FIRE ENCLOSURE itself, the requirements in 4.6.2 continue to apply to the FIRE ENCLOSURE.

- meter cases (if otherwise determined to be suitable for mounting of parts at HAZARDOUS VOLTAGE), meter faces and indicator lamps or their jewels;
- electronic components, such as integrated circuit packages, optocoupler packages, capacitors and other small parts that are mounted on V-1 CLASS MATERIAL;
- wiring, cables and connectors insulated with PVC, TFE, PTFE, FEP, polychloroprene or polyimide;
- individual clamps (not including helical wraps or other continuous forms), lacing tape, twine and cable ties used with wiring harnesses;

- the following parts, provided that they are separated from electrical parts (other than insulated wires and cables), which under fault conditions are likely to produce a temperature that could cause ignition, by at least 13 mm of air or by a solid barrier of V-1 CLASS MATERIAL:
 - gears, cams, belts, bearings and other small parts that would contribute negligible fuel to a fire, including, labels, mounting feet, key caps, knobs and the like;
 - supplies, consumable materials, media and recording materials;
 - parts that are required to have particular properties in order to perform intended functions, such as rubber rollers for paper pick-up and delivery, and ink tubes;
 - tubing for air or any fluid systems, containers for powders or liquids and foamed plastic parts, provided that they are of HB75 CLASS MATERIAL if the thinnest significant thickness of the material is < 3 mm, or HB40 CLASS MATERIAL if the thinnest significant thickness of the material is ≥ 3 mm, or HBF CLASS FOAMED MATERIAL.

Compliance is checked by inspection of the equipment and material data sheets and, if necessary, by the appropriate test or tests of Annex A.

4.7.3.5 Materials for air filter assemblies

Air filter assemblies shall be constructed of V-2 CLASS MATERIAL, OR HF-2 CLASS FOAMED MATERIAL.

This requirement does not apply to the following constructions:

- air filter assemblies in air circulating systems, whether or not airtight, that are not intended to be vented outside the FIRE ENCLOSURE;
- air filter assemblies located inside or outside a FIRE ENCLOSURE, provided that the filter materials are separated by a metal screen from parts that could cause ignition. This screen may be perforated and shall meet the requirements of 4.6.2 for the bottoms of FIRE ENCLOSURES;
- air filter assemblies constructed of
 - HB75 CLASS MATERIAL if the thinnest significant thickness of this material is < 3 mm, or
 - HB40 CLASS MATERIAL if the thinnest significant thickness of this material is ≥ 3 mm, or
 - HBF CLASS FOAMED MATERIAL,provided that they are separated by at least 13 mm of air, or by a solid barrier of V-1 CLASS MATERIAL, from electrical parts (other than insulated wires and cables) which under fault conditions are likely to produce a temperature that could cause ignition.

Compliance is checked by inspection of the equipment and material data sheets and, if necessary, by appropriate tests.

4.7.3.6 Materials used in high-voltage components

High-voltage components operating at peak-to-peak voltages exceeding 4 kV shall either be of V-2 CLASS MATERIAL, OR HF-2 CLASS FOAMED MATERIAL, or comply with 14.4 of IEC 60065 or pass the needle flame test according to IEC 60695-11-5.

Compliance is checked by inspection of the equipment and material data sheets and, if necessary, by

- the tests for V-2 CLASS MATERIAL or HF-2 CLASS FOAMED MATERIAL; or
- the test described in 14.4 of IEC 60065; or
- the needle flame test according to IEC 60695-11-5.

In addition, the following details apply, referring to clauses of IEC 60695-11-5:

Clause 7 – Severities

The test flame is applied for 10 s. If a self-sustaining flame does not last longer than 30 s, the test flame is applied again for 1 min at the same point or at any other point. If again a self-sustaining flame does not last longer than 30 s, the test flame is then applied for 2 min at the same point or at any other point.

Clause 8 – Conditioning

Except for high voltage transformers and high voltage multipliers the samples are stored for 2 h in an oven at a temperature of $100\text{ }^{\circ}\text{C} \pm 2\text{ }^{\circ}\text{C}$.

For high voltage transformers, a power of 10 W (d.c. or a.c. at mains frequency) is initially supplied to the high-voltage winding. This power is maintained for 2 min, after which it is increased by successive steps of 10 W at 2 min intervals to 40 W.

The treatment lasts 8 min or is terminated as soon as interruption of the winding or appreciable splitting of the protective covering occurs.

NOTE 1 Certain transformers are so designed that this preconditioning cannot be conducted. In such cases the oven preconditioning applies.

For high-voltage multipliers, a voltage taken from an appropriate high-voltage transformer, is supplied to each sample, its output circuit being short-circuited.

The input voltage is adjusted so that the short-circuit current is initially $25\text{ mA} \pm 5\text{ mA}$. This current is maintained for 30 min or is terminated as soon as any interruption of the circuit or appreciable splitting of the protective covering occurs.

NOTE 2 Where the design of a high-voltage multiplier is such that a short-circuit current of 25 mA cannot be obtained, a preconditioning current is used, which represents the maximum attainable current, determined either by the design of the multiplier or by its conditions of use in a particular apparatus.

Clause 11 – Evaluation of test results

After the first application of the test flame, the test sample shall not be consumed completely.

After any application of the test flame, any self-sustaining flame shall extinguish within 30 s. No burning of the WRAPPING TISSUE shall occur and the board shall not be scorched.

Table 4E – Summary of material flammability requirements

| Part | | Requirement |
|---|---|--|
| FIRE ENCLOSURES 4.7.3.2 | MOVABLE EQUIPMENT > 18 kg and STATIONARY EQUIPMENT | <ul style="list-style-type: none"> - 5VB - Test A.1 - Hot wire test of IEC 60695-2-20 (If <13 mm of air from parts at high temperatures that could cause ignition) |
| | MOVABLE EQUIPMENT ≤ 18 kg | <ul style="list-style-type: none"> - V-1 - Test A.2 - Hot wire test of IEC 60695-2-20 (If < 13 mm of air from parts at high temperatures that could cause ignition) |
| | Parts that fill an opening | <ul style="list-style-type: none"> - V-1 - Test A.2 - Component standard |
| Components and parts, including MECHANICAL ENCLOSURES and ELECTRICAL ENCLOSURES, outside FIRE ENCLOSURES 4.7.3.1 and 4.7.3.3 | | <ul style="list-style-type: none"> - HB40 for thicknesses ≥ 3 mm - HB75 for thicknesses < 3 mm - HBF - Glow-wire test 550 °C of IEC 60695-2-11 <p>For connectors and exceptions see 4.7.3.3</p> |
| Components and parts, including MECHANICAL ENCLOSURES and ELECTRICAL ENCLOSURES, inside FIRE ENCLOSURES 4.7.3.4 | | <ul style="list-style-type: none"> - V-2 - HF-2 - Test A.2 - Component standard <p>For exceptions see 4.7.3.4</p> |
| Air filter assemblies 4.7.3.5 | | <ul style="list-style-type: none"> - V-2 - HF-2 - Test A.2 <p>For exceptions see 4.7.3.5</p> |
| High voltage (> 4 kV) components 4.7.3.6 | | <ul style="list-style-type: none"> - V-2 - HF-2 - Test of 14.4 of IEC 60065 - Needle flame test of IEC 60695-11-5 |

5 Electrical requirements and simulated abnormal conditions

5.1 Touch current and protective conductor current

In this subclause measurements of current through networks simulating the impedance of the human body are referred to as measurements of TOUCH CURRENT.

Except for application of 5.1.8.2, these requirements do not apply to equipment intended to be supplied by only a DC MAINS SUPPLY.

5.1.1 General

Equipment shall be so designed and constructed that neither TOUCH CURRENT NOR PROTECTIVE CONDUCTOR CURRENT is likely to create an electric shock hazard.

Compliance is checked by testing in accordance with 5.1.2 to 5.1.7 inclusive, and, if relevant, 5.1.8 (see also 1.4.4).

However, if it is clear from a study of the circuit diagrams of either STATIONARY PERMANENTLY CONNECTED EQUIPMENT or STATIONARY PLUGGABLE EQUIPMENT TYPE B, that has a PROTECTIVE EARTHING CONDUCTOR, that the TOUCH CURRENT will exceed 3,5 mA r.m.s., but that the PROTECTIVE CONDUCTOR CURRENT will not exceed 5 % of input current, the tests of 5.1.5, 5.1.6 and 5.1.7.1 a) are not made.

NOTE In the above case, the requirement of 5.1.7.1 b) continues to apply.

5.1.2 Configuration of equipment under test (EUT)

5.1.2.1 Single connection to an a.c. mains supply

Systems of interconnected equipment with individual connections to the AC MAINS SUPPLY shall have each piece of equipment tested separately. Systems of interconnected equipment with one common connection to the AC MAINS SUPPLY shall be treated as a single piece of equipment. See also 1.4.10 regarding the inclusion of optional features.

NOTE Systems of interconnected equipment are specified in more detail in Annex A of IEC 60990.

5.1.2.2 Redundant multiple connections to an a.c. mains supply

Equipment that is designed for multiple connections to the AC MAINS SUPPLY, only one of which is required at a time, shall be tested with only one connection.

5.1.2.3 Simultaneous multiple connections to an a.c. mains supply

Equipment requiring power simultaneously from two or more AC MAINS SUPPLIES shall be tested with all AC MAINS SUPPLIES connected.

The total TOUCH CURRENT through all PROTECTIVE EARTHING CONDUCTORS that are connected to each other and to earth is measured.

A PROTECTIVE EARTHING CONDUCTOR that is not connected within the equipment to other earthed parts in the equipment shall not be included in the above tests. If an a.c. power source has such a PROTECTIVE EARTHING CONDUCTOR it shall be tested separately according to 5.1.2.1 (see also 5.1.7.2).

5.1.3 Test circuit

Equipment is tested using the test circuit in Figure 5A (for single-phase equipment to be connected only to a star TN or TT power distribution system) or Figure 5B (for three-phase equipment to be connected only to a star TN or TT power distribution system) or where appropriate, another test circuit from Figures 7, 9, 10, 12, 13 or 14 of IEC 60990.

The use of a test transformer for isolation is optional. For maximum protection, a test transformer for isolation (T in Figures 5A and 5B) is used and the main protective earthing terminal of the EUT is earthed. Any capacitive leakage in the transformer shall then be taken into account. As an alternative to earthing the EUT, the test transformer secondary and the EUT are left floating (not earthed) in which case capacitive leakage in the transformer need not be taken into account.

If transformer T is not used, the EUT and the test circuitry shall not be earthed. The EUT is mounted on an insulating stand, and appropriate safety precautions are taken in view of the possibility of the BODY of the equipment being at a HAZARDOUS VOLTAGE.

Equipment to be connected to an IT power distribution system is tested accordingly (see Figures 9, 10 and 12 of IEC 60990). Such equipment may also be connected to a TN or TT power distribution system without further test.

Single-phase equipment intended to be operated between two line conductors is tested using a three-phase test circuit such as Figure 5B.

If it is inconvenient to test equipment at the most unfavourable supply voltage (see 1.4.5), it is permitted to test the equipment at any available voltage within the tolerance of RATED VOLTAGE or within the RATED VOLTAGE RANGE, and then calculate the results.

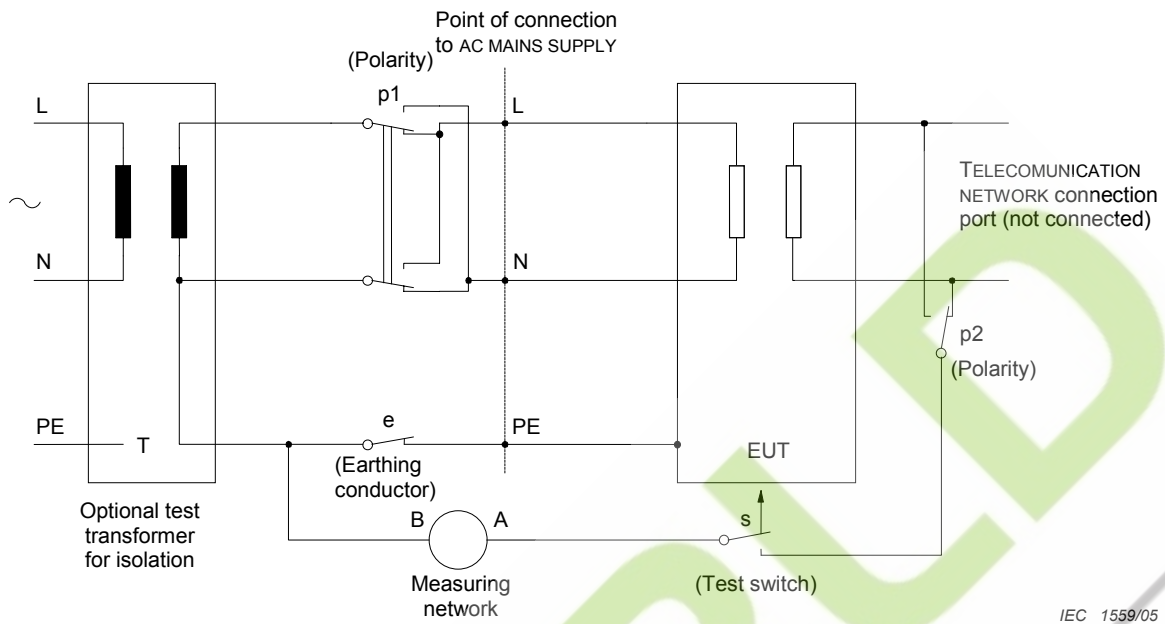

IEC 1559/05

NOTE This figure is derived from Figure 6 of IEC 60990.

Figure 5A – Test circuit for touch current of single-phase equipment on a star TN or TT power supply system

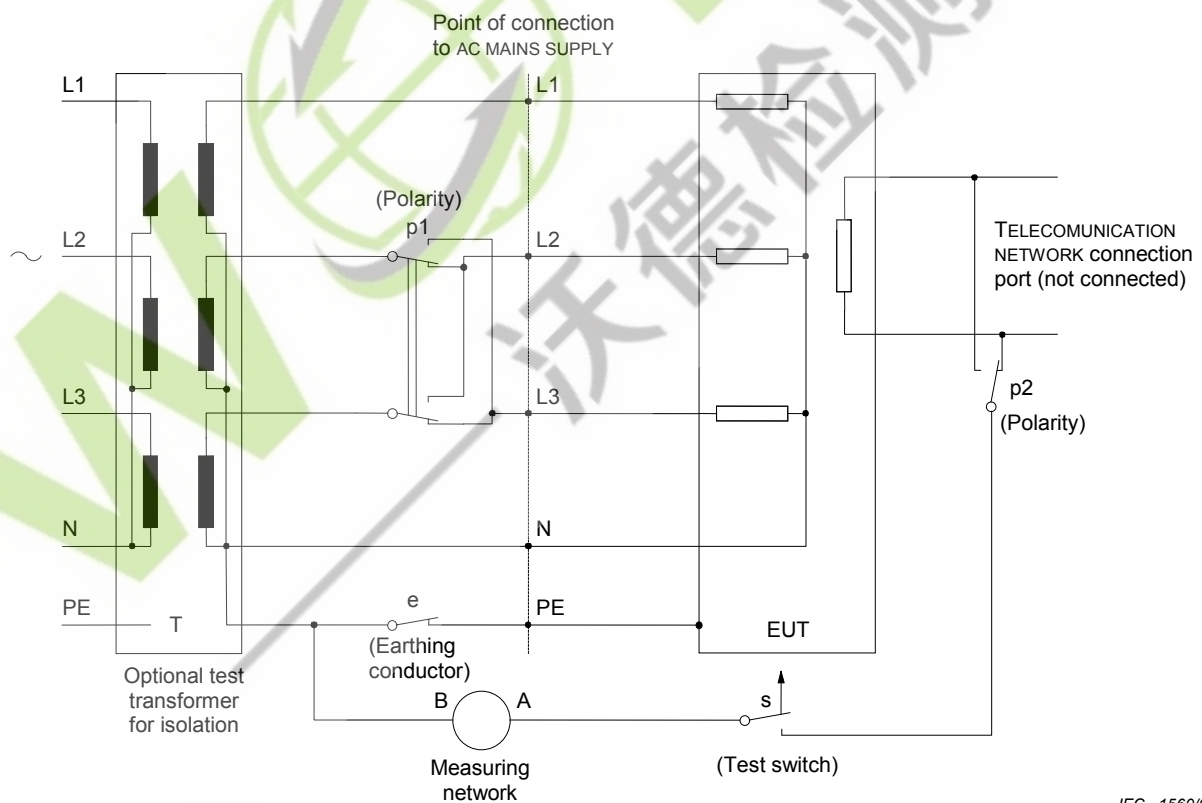

IEC 1560/05

NOTE This figure is derived from Figure 11 of IEC 60990.

Figure 5B – Test circuit for touch current of three-phase equipment on a star TN or TT power supply system

5.1.4 Application of measuring instrument

Tests are conducted using one of the measuring instruments in Annex D, or any other circuit giving the same results.

Terminal B of the measuring instrument is connected to the earthed (neutral) conductor of the supply (see Figure 5A or 5B).

Terminal A of the measuring instrument is connected as specified in 5.1.5.

For an accessible non-conductive part, the test is made to metal foil having dimensions of 100 mm by 200 mm in contact with the part. If the area of the foil is smaller than the surface under test, the foil is moved so as to test all parts of the surface. Where adhesive metal foil is used, the adhesive shall be conductive. Precautions are taken to prevent the metal foil from affecting the heat dissipation of the equipment.

NOTE 1 The foil test simulates hand contact.

Accessible conductive parts that are incidentally connected to other parts are tested both as connected and disconnected parts.

NOTE 2 Incidentally connected parts are described in more detail in Annex C of IEC 60990.

5.1.5 Test procedure

For equipment having a protective earthing connection or a FUNCTIONAL EARTHING connection, terminal A of the measuring instrument is connected via measurement switch "s" to the main protective earthing terminal of the EUT, with the earthing conductor switch "e" open.

The test is also conducted, on all equipment, with terminal A of the measuring network connected via measurement switch "s" to each unearthed or non-conductive accessible part and each unearthed accessible circuit, in turn, with the earthing conductor switch "e" closed.

Additionally:

- for single-phase equipment, the tests are repeated in reverse polarity (switch "p1");
- for three-phase equipment, the tests are repeated in reverse polarity (switch "p1") unless the equipment is sensitive to phase sequence.

When testing three-phase equipment, any components used for EMC purposes and connected between line and earth are disconnected one at a time; for this purpose, groups of components in parallel connected through a single connection are treated as single components. Each time a line-to-earth component is disconnected the sequence of switch operations is repeated.

NOTE Where filters are normally encapsulated, it may be necessary to provide an unencapsulated unit for test or to simulate the filter network.

For each placement of the measuring instrument, any switches in the PRIMARY CIRCUIT and likely to be operated in normal use are open and closed in all possible combinations.

After applying each test condition, the equipment is restored to its original condition, that is without fault or consequential damage.

5.1.6 Test measurements

Either the r.m.s. value of the voltage, U_2 , is measured using the measuring instrument of Figure D.1, or the r.m.s. value of the current is measured using the measuring instrument of Figure D.2.

The D.1 instrument gives a more accurate measurement than the D.2 instrument if the waveform is non-sinusoidal and the fundamental frequency exceeds 100 Hz.

Alternatively, the peak value of the voltage, U_2 , is measured using the measuring instrument described in Clause D.1.

If the voltage, U_2 , is measured using the measuring instrument described in Clause D.1, the following calculation is used:

$$\text{TOUCH CURRENT (A)} = U_2 / 500$$

NOTE Although r.m.s. values of TOUCH CURRENT have traditionally been measured, peak values provide better correlation with the response of the human body to non-sinusoidal current waveforms.

None of the values measured in accordance with 5.1.6 shall exceed the relevant limits in Table 5A, except as permitted in 2.4 (see also 1.5.6 and 1.5.7) and 5.1.7.

Table 5A – Maximum current

| Type of equipment | Terminal A of measuring instrument connected to: | Maximum TOUCH CURRENT mA r.m.s. ^a | Maximum PROTECTIVE CONDUCTOR CURRENT |
|---|--|--|--------------------------------------|
| All equipment | Accessible parts and circuits not connected to protective earth ^b | 0,25 | – |
| HAND-HELD | Equipment main protective earthing terminal (if any) | 0,75 | – |
| MOVABLE (other than HAND-HELD, but including TRANSPORTABLE EQUIPMENT) | | 3,5 | – |
| STATIONARY, PLUGGABLE TYPE A | | 3,5 | – |
| All other STATIONARY EQUIPMENT | | 3,5 | – |
| – not subject to the conditions of 5.1.7 | | – | 5 % of input current |
| – subject to the conditions of 5.1.7 | | | |

^a If peak values of TOUCH CURRENT are measured, the maximum values are obtained by multiplying the r.m.s. values in the table by 1,414.

^b Some unearthed accessible parts are covered in 1.5.6 and 1.5.7 and the requirements of 2.4 apply. These may be different from those in 5.1.6.

5.1.7 Equipment with touch current exceeding 3,5 mA

5.1.7.1 General

TOUCH CURRENT measurement results exceeding 3,5 mA r.m.s. are permitted for the following equipment having a main protective earthing terminal:

- STATIONARY PERMANENTLY CONNECTED EQUIPMENT;
- STATIONARY PLUGGABLE EQUIPMENT TYPE B;
- STATIONARY PLUGGABLE EQUIPMENT TYPE A with a single connection to the AC MAINS SUPPLY, and provided with a separate protective earthing terminal in addition to the main protective earthing terminal, if any (see 2.6.4.1). The installation instructions shall specify that this separate protective earthing terminal be permanently connected to earth;

NOTE 1 The above equipment is not required to be installed in a RESTRICTED ACCESS LOCATION. However, the requirement to be STATIONARY EQUIPMENT is more onerous than the similar requirements in 2.3.2.3 a) because the potential hazard is greater.

- MOVABLE OR STATIONARY PLUGGABLE EQUIPMENT TYPE A for use in a RESTRICTED ACCESS LOCATION, with a single connection to the AC MAINS SUPPLY, and provided with a separate protective earthing terminal in addition to the main protective earthing terminal, if any (see 2.6.4.1). The installation instructions shall specify that this separate protective earthing terminal be permanently connected to earth;

NOTE 2 The limitation of use to a RESTRICTED ACCESS LOCATION is more onerous than the similar requirements in 2.3.2.3 a) because the potential hazard is greater.

- STATIONARY PLUGGABLE EQUIPMENT TYPE A with simultaneous multiple connections to the AC MAINS SUPPLY, intended to be used in a location having equipotential bonding (such as a telecommunication centre, a dedicated computer room or a RESTRICTED ACCESS LOCATION). A separate additional protective earthing terminal shall be provided on the equipment. The installation instructions shall require all of the following:
 - the building installation shall provide a means for connection to protective earth; and
 - the equipment is to be connected to that means; and
 - a SERVICE PERSON shall check whether or not the socket-outlet from which the equipment is to be powered provides a connection to the building protective earth. If not, the SERVICE PERSON shall arrange for the installation of a PROTECTIVE EARTHING CONDUCTOR from the separate protective earthing terminal to the protective earth wire in the building.

Ⓒ Notes deleted Ⓒ

If the result of the TOUCH CURRENT measurement on any of the above equipments exceeds 3,5 mA r.m.s., the following requirements a) and b) apply, and also, if relevant, those in 5.1.7.2.

- a) The r.m.s. PROTECTIVE CONDUCTOR CURRENT shall not exceed 5 % of the input current per line under normal operating conditions. If the load is unbalanced, the largest of the three line currents shall be used for this calculation.

To measure the PROTECTIVE CONDUCTOR CURRENT, the procedure for measuring TOUCH CURRENT is used but the measuring instrument is replaced by an ammeter of negligible impedance; and

- b) one of the following labels, or a label with similar wording, shall be affixed adjacent to the equipment AC MAINS SUPPLY connection:

WARNING
HIGH LEAKAGE CURRENT
EARTH CONNECTION ESSENTIAL
BEFORE CONNECTING SUPPLY

WARNING
HIGH TOUCH CURRENT
EARTH CONNECTION ESSENTIAL
BEFORE CONNECTING SUPPLY

Compliance is checked by inspection and measurement.

5.1.7.2 Simultaneous multiple connections to the supply

The following applies to EUT tested in accordance with 5.1.2.3. If the result of the total TOUCH CURRENT measurement exceeds 3,5 mA r.m.s., the test is repeated with each AC MAINS SUPPLY and its PROTECTIVE EARTHING CONDUCTOR connected one at a time, with the other AC MAINS SUPPLIES, including their PROTECTIVE EARTHING CONDUCTORS, disconnected. However, if two connections to the AC MAINS SUPPLY are inseparable, for example, connections for a motor and its control circuits, they shall both be energized for a repeat test.

NOTE It is not expected that the EUT will operate normally during this test.

If the result of the TOUCH CURRENT measurement for any of the repeat tests exceeds 3,5 mA r.m.s., the requirements of 5.1.7.1 a) apply to that connection to the AC MAINS SUPPLY. For calculating 5 % of the input current per line, the input current from the AC MAINS SUPPLY, measured during the repeat test, is used.

5.1.8 Touch currents to telecommunication networks and cable distribution systems and from telecommunication networks

NOTE In this subclause, references to "TELECOMMUNICATION NETWORK connection ports" (or telecommunication ports) are intended to cover those connection points to which a TELECOMMUNICATION NETWORK is intended to be attached. Such references are not intended to include other data ports, such as those commonly identified as serial, parallel, keyboard, game, joystick, etc.

5.1.8.1 Limitation of the touch current to a telecommunication network or to a cable distribution system

The TOUCH CURRENT from equipment supplied from the AC MAINS SUPPLY to a TELECOMMUNICATION NETWORK or a CABLE DISTRIBUTION SYSTEM shall be limited.

Compliance is checked using the test circuit detailed in 5.1.3.

The tests are not applied to equipment where the circuit to be connected to a TELECOMMUNICATION NETWORK or a CABLE DISTRIBUTION SYSTEM is connected to a protective earthing terminal in the equipment; the TOUCH CURRENT from the EUT to the TELECOMMUNICATION NETWORK or the CABLE DISTRIBUTION SYSTEM is considered to be zero.

For equipment having more than one circuit to be connected to a TELECOMMUNICATION NETWORK or a CABLE DISTRIBUTION SYSTEM, the test is applied to only one example of each type of circuit.

For equipment that has no main protective earthing terminal, the earthing conductor switch "e", if connected to a FUNCTIONAL EARTHING terminal on the EUT, is left open. Otherwise it is closed.

Terminal B of the measuring instrument is connected to the earthed (neutral) conductor of the supply. Terminal A is connected via the measurement switch "s" and the polarity switch "p2" to the TELECOMMUNICATION NETWORK or CABLE DISTRIBUTION SYSTEM connection port.

For single-phase equipment, the test is made in all combinations of the polarity switches "p1" and "p2".

For three-phase equipment, the test is made in both positions of polarity switch "p2".

After applying each test condition, the equipment is restored to its original operating state.

Test measurements are made using one of the measuring instruments of Annex D as described in 5.1.6.

None of the values measured in accordance with 5.1.8.1 shall exceed 0,25 mA r.m.s.

5.1.8.2 Summation of touch currents from telecommunication networks

NOTE Annex W explains the background to 5.1.8.2.

An EUT that provides TELECOMMUNICATION NETWORK connection ports for connection of multiple items of other telecommunication equipment, shall not create a hazard for USERS and TELECOMMUNICATION NETWORK SERVICE PERSONS due to summation of TOUCH CURRENT.

In these requirements, abbreviations have the following meanings:

- I_1 is the TOUCH CURRENT received from other equipment via a TELECOMMUNICATION NETWORK at a telecommunication port of the EUT;
- $\sum I_1$ is the summation of TOUCH CURRENTS received from other equipment at all such telecommunication ports of the EUT;
- I_2 is the TOUCH CURRENT due to the AC MAINS SUPPLY of the EUT.

It shall be assumed that each telecommunication port receives 0,25 mA (I_1) from the other equipment, unless the actual current from the other equipment is known to be lower.

The following requirements, a) or b) as applicable, shall be met:

a) EUT with earthed telecommunication ports

For an EUT in which each telecommunication port is connected to the main protective earthing terminal of the EUT, the following items 1), 2) and 3) shall be considered:

- 1) If ΣI_1 (not including I_2) exceeds 3,5 mA:
 - the equipment shall have provision for a permanent connection to protective earth in addition to the PROTECTIVE EARTHING CONDUCTOR in the power supply cord of PLUGGABLE EQUIPMENT TYPE A or PLUGGABLE EQUIPMENT B; and
 - the installation instructions shall specify the provision of a permanent connection to protective earth with a cross-sectional area of not less than 2,5 mm², if mechanically protected, or otherwise 4,0 mm²; and
 - one of the following labels, or a label with similar wording, shall be affixed adjacent to the permanent earth connection. It is permitted to combine this label with the label in 5.1.7.1 b).

WARNING
HIGH LEAKAGE CURRENT
EARTH CONNECTION ESSENTIAL
BEFORE MAKING
TELECOMMUNICATION NETWORK
CONNECTIONS

WARNING
HIGH TOUCH CURRENT
EARTH CONNECTION ESSENTIAL
BEFORE MAKING
TELECOMMUNICATION NETWORK
CONNECTIONS

- 2) ΣI_1 plus I_2 shall comply with the limits in Table 5A (see 5.1.6).
- 3) If relevant, such equipment shall comply with 5.1.7. The value of I_2 shall be used to calculate the 5 % input current limit per phase specified in 5.1.7.

Compliance with item a) is checked by inspection and, if necessary, by test.

If the equipment has provision for a permanent protective earth connection in accordance with item 1) above, it is not necessary to make any measurements, except that I_2 shall comply with the relevant requirements of 5.1.

TOUCH CURRENT tests, if necessary, are made using the relevant measuring instrument described in Annex D or any other instrument giving the same results. A capacitively coupled a.c. source of the same line frequency and phase as the AC MAINS SUPPLY is applied to each telecommunication port such that 0,25 mA, or the actual current from other equipment if known to be lower, is available to flow into that telecommunication port. The current flowing in the earthing conductor is then measured.

b) EUT whose telecommunication ports have no reference to protective earth

If the telecommunication ports on the EUT do not have a common connection, each telecommunication port shall comply with 5.1.8.1.

If all telecommunication ports or any groups of such ports have a common connection, the total TOUCH CURRENT from each common connection shall not exceed 3,5 mA.

Compliance with item b) is checked by inspection and, if necessary, by the tests of 5.1.8.1 or, if there are common connection points, by the following test.

A capacitively coupled a.c. source of the same frequency and phase as the AC MAINS SUPPLY is applied to each telecommunication port such that 0,25 mA, or the actual current from the other equipment if known to be lower, is available to flow into that telecommunication port. Common connection points are tested in accordance with 5.1, whether or not the points are accessible.

5.2 Electric strength

NOTE Where specific reference to conducting the electric strength test according to 5.2 is made in other parts of this standard, it is intended that the electric strength test be conducted with the equipment in a well-heated condition according to 5.2.1.

Where specific reference to conducting the electric strength test according to 5.2.2 is made in other parts of this standard, it is intended that the electric strength test be conducted without preheating according to 5.2.1.

5.2.1 General

The electric strength of the SOLID INSULATION used in the equipment shall be adequate.

Compliance is checked in accordance with 5.2.2 while the equipment is still in a well-heated condition immediately following the temperature test in 4.5.2.

If a component or subassembly is tested separately outside the equipment, it is brought to the temperature attained by that part during the temperature test in 4.5.2 (for example, by placing it in an oven) prior to performing the electric strength test. However, it is permitted to conduct electric strength testing of thin sheet material for SUPPLEMENTARY INSULATION or REINFORCED INSULATION, according to 2.10.5.9 or 2.10.5.10, at room temperature.

No electric strength test applies to insulation in a transformer between any winding and the core or screen, provided that the core or screen is totally enclosed or encapsulated and there is no electrical connection to the core or screen. However, the tests between parts that have terminations continue to apply.

5.2.2 Test procedure

Unless otherwise specified elsewhere in this standard the insulation is subjected either to a voltage of substantially sine-wave form having a frequency of 50 Hz or 60 Hz, or to a d.c. test voltage equal to the peak voltage of the prescribed a.c. test voltage.

The test voltages for electric strength for the appropriate grade of insulation [FUNCTIONAL INSULATION if required by 5.3.4 b), BASIC INSULATION, SUPPLEMENTARY INSULATION or REINFORCED INSULATION] are as specified in either:

- Table 5B using the PEAK WORKING VOLTAGE (U), as determined in 2.10.2; or*
- Table 5C using the REQUIRED WITHSTAND VOLTAGE, as determined in G.4.*

NOTE 1 In various places in this standard, special electric strength tests or test voltages are specified for certain situations. The test voltages in 5.2.2 do not apply to these situations.

NOTE 2 For consideration of temporary overvoltages, see IEC 60664-1.

For equipment in Overvoltage Category I and Overvoltage Category II, it is permitted to use either Table 5B or Table 5C. However, for a SECONDARY CIRCUIT that is neither connected to protective earth nor provided with a protective screen in accordance with 2.6.1 e), Table 5C shall be used.

For equipment in Overvoltage Category III and Overvoltage Category IV, Table 5C shall be used.

The voltage applied to the insulation under test is gradually raised from zero to the prescribed voltage and held at that value for 60 s.

Where, elsewhere in this standard, ROUTINE TESTS are required to be conducted in accordance with 5.2.2, it is permitted to reduce the duration of the electric strength test to 1 s and to reduce the test voltage permitted in Table 5C, if used, by 10 %.

There shall be no insulation breakdown during the test.

Insulation breakdown is considered to have occurred when the current that flows as a result of the application of the test voltage rapidly increases in an uncontrolled manner, that is the insulation does not restrict the flow of the current. Corona discharge or a single momentary flashover is not regarded as insulation breakdown.

Insulation coatings are tested with metal foil in contact with the insulating surface. This procedure is limited to places where the insulation is likely to be weak, for example, where there are sharp metal edges under the insulation. If practicable, insulating linings are tested separately. Care is taken that the metal foil is so placed that no flashover occurs at the edges of the insulation. Where adhesive metal foil is used, the adhesive shall be conductive.

To avoid damage to components or insulation that are not involved in the test, disconnection of integrated circuits or the like and the use of equipotential bonding are permitted.

For equipment incorporating both REINFORCED INSULATION and lower grades of insulation, care is taken that the voltage applied to the REINFORCED INSULATION does not overstress BASIC INSULATION or SUPPLEMENTARY INSULATION.

NOTE 3 Where there are capacitors across the insulation under test (for example, radio-frequency filter capacitors), it is recommended that d.c. test voltages are used.

NOTE 4 Components providing a d.c. path in parallel with the insulation to be tested, such as discharge resistors for filter capacitors, voltage limiting devices or surge suppressors, should be disconnected.

Where insulation of a transformer winding varies along the length of the winding in accordance with 2.10.1.5, an electric strength test method is used that stresses the insulation accordingly.

NOTE 5 An example of such a test method is an induced voltage test that is applied at a frequency sufficiently high to avoid saturation of the transformer. The input voltage is raised to a value that would induce an output voltage equal to the specified test voltage.

No test is applied to FUNCTIONAL INSULATION, unless 5.3.4 b) has been selected.

Table 5B – Test voltages for electric strength tests based on peak working voltages Part 1

| Grade of Insulation | Points of application (as appropriate) | | | | | | |
|--|--|---|--|---|--------------------------------------|---|---|
| | PRIMARY CIRCUIT to BODY PRIMARY CIRCUIT to SECONDARY CIRCUIT between parts in PRIMARY CIRCUITS | | | | | SECONDARY CIRCUIT to BODY between independent SECONDARY CIRCUITS | |
| | WORKING VOLTAGE U , peak or d.c. | | | | | WORKING VOLTAGE U | |
| | Up to and including 210 V ^a | Over 210 V up to and including 420 V ^b | Over 420 V up to and including 1,41 kV | Over 1,41 kV up to and including 10 kV ^c | Over 10 kV up to and including 50 kV | Up to and including 42,4 V peak or 60 V d.c. ^d | Over 42,4 V peak or 60 V d.c. up to and including 10 kV peak or d.c. ^d |
| | Test voltage, volts a.c. r.m.s. | | | | | | |
| FUNCTIONAL | 1 000 | 1 500 | see V_a in Table 5B, part 2 | see V_a in Table 5B, part 2 | 1,06 U | 500 | see V_a in Table 5B, part 2 |
| BASIC, SUPPLEMENTARY | 1 000 | 1 500 | see V_a in Table 5B, part 2 | see V_a in Table 5B, part 2 | 1,06 U | No test | see V_a in Table 5B, part 2 |
| REINFORCED | 2 000 | 3 000 | 3 000 | see V_b in Table 5B, part 2 | 1,06 U | No test | see V_b in Table 5B, part 2 |
| <p>For PEAK WORKING VOLTAGES exceeding 10 kV peak or d.c. in SECONDARY CIRCUITS, the same test voltages as for PRIMARY CIRCUITS apply.</p> <p>^a Use this column for unearthed DC MAINS SUPPLIES up to and including 210 V [see 2.10.3.2 c)].</p> <p>^b Use this column for unearthed DC MAINS SUPPLIES over 210 V, up to and including 420 V [see 2.10.3.2 c)].</p> <p>^c Use this column for unearthed DC MAINS SUPPLIES over 420 V [see 2.10.3.2 c)].</p> <p>^d Use these columns for d.c. derived within the equipment from an AC MAINS SUPPLY or for DC MAINS SUPPLIES that are earthed within the same building.</p> | | | | | | | |

**Table 5B – Test voltages for electric strength tests
based on peak working voltages**

Part 2

| <i>U</i> peak or d.c. | <i>V_a</i> a.c. r.m.s. | <i>V_b</i> a.c. r.m.s. | <i>U</i> peak or d.c. | <i>V_a</i> a.c. r.m.s. | <i>V_b</i> a.c. r.m.s. | <i>U</i> peak or d.c. | <i>V_a</i> a.c. r.m.s. | <i>V_b</i> a.c. r.m.s. |
|-----------------------------|-------------------------------------|-------------------------------------|-----------------------------|-------------------------------------|-------------------------------------|-----------------------------|-------------------------------------|-------------------------------------|
| 34 | 500 | 800 | 250 | 1 261 | 2 018 | 1 750 | 3 257 | 3 257 |
| 35 | 507 | 811 | 260 | 1 285 | 2 055 | 1 800 | 3 320 | 3 320 |
| 36 | 513 | 821 | 270 | 1 307 | 2 092 | 1 900 | 3 444 | 3 444 |
| 38 | 526 | 842 | 280 | 1 330 | 2 127 | 2 000 | 3 566 | 3 566 |
| 40 | 539 | 863 | 290 | 1 351 | 2 162 | 2 100 | 3 685 | 3 685 |
| 42 | 551 | 882 | 300 | 1 373 | 2 196 | 2 200 | 3 803 | 3 803 |
| 44 | 564 | 902 | 310 | 1 394 | 2 230 | 2 300 | 3 920 | 3 920 |
| 46 | 575 | 920 | 320 | 1 414 | 2 263 | 2 400 | 4 034 | 4 034 |
| 48 | 587 | 939 | 330 | 1 435 | 2 296 | 2 500 | 4 147 | 4 147 |
| 50 | 598 | 957 | 340 | 1 455 | 2 328 | 2 600 | 4 259 | 4 259 |
| 52 | 609 | 974 | 350 | 1 474 | 2 359 | 2 700 | 4 369 | 4 369 |
| 54 | 620 | 991 | 360 | 1 494 | 2 390 | 2 800 | 4 478 | 4 478 |
| 56 | 630 | 1 008 | 380 | 1 532 | 2 451 | 2 900 | 4 586 | 4 586 |
| 58 | 641 | 1 025 | 400 | 1 569 | 2 510 | 3 000 | 4 693 | 4 693 |
| 60 | 651 | 1 041 | 420 | 1 605 | 2 567 | 3 100 | 4 798 | 4 798 |
| 62 | 661 | 1 057 | 440 | 1 640 | 2 623 | 3 200 | 4 902 | 4 902 |
| 64 | 670 | 1 073 | 460 | 1 674 | 2 678 | 3 300 | 5 006 | 5 006 |
| 66 | 680 | 1 088 | 480 | 1 707 | 2 731 | 3 400 | 5 108 | 5 108 |
| 68 | 690 | 1 103 | 500 | 1 740 | 2 784 | 3 500 | 5 209 | 5 209 |
| 70 | 699 | 1 118 | 520 | 1 772 | 2 835 | 3 600 | 5 309 | 5 309 |
| 72 | 708 | 1 133 | 540 | 1 803 | 2 885 | 3 800 | 5 507 | 5 507 |
| 74 | 717 | 1 147 | 560 | 1 834 | 2 934 | 4 000 | 5 702 | 5 702 |
| 76 | 726 | 1 162 | 580 | 1 864 | 2 982 | 4 200 | 5 894 | 5 894 |
| 78 | 735 | 1 176 | 588 | 1 875 | 3 000 | 4 400 | 6 082 | 6 082 |
| 80 | 744 | 1 190 | 600 | 1 893 | 3 000 | 4 600 | 6 268 | 6 268 |
| 85 | 765 | 1 224 | 620 | 1 922 | 3 000 | 4 800 | 6 452 | 6 452 |
| 90 | 785 | 1 257 | 640 | 1 951 | 3 000 | 5 000 | 6 633 | 6 633 |
| 95 | 805 | 1 288 | 660 | 1 979 | 3 000 | 5 200 | 6 811 | 6 811 |
| 100 | 825 | 1 319 | 680 | 2 006 | 3 000 | 5 400 | 6 987 | 6 987 |
| 105 | 844 | 1 350 | 700 | 2 034 | 3 000 | 5 600 | 7 162 | 7 162 |
| 110 | 862 | 1 379 | 720 | 2 060 | 3 000 | 5 800 | 7 334 | 7 334 |
| 115 | 880 | 1 408 | 740 | 2 087 | 3 000 | 6 000 | 7 504 | 7 504 |
| 120 | 897 | 1 436 | 760 | 2 113 | 3 000 | 6 200 | 7 673 | 7 673 |
| 125 | 915 | 1 463 | 780 | 2 138 | 3 000 | 6 400 | 7 840 | 7 840 |
| 130 | 931 | 1 490 | 800 | 2 164 | 3 000 | 6 600 | 8 005 | 8 005 |
| 135 | 948 | 1 517 | 850 | 2 225 | 3 000 | 6 800 | 8 168 | 8 168 |
| 140 | 964 | 1 542 | 900 | 2 285 | 3 000 | 7 000 | 8 330 | 8 330 |
| 145 | 980 | 1 568 | 950 | 2 343 | 3 000 | 7 200 | 8 491 | 8 491 |
| 150 | 995 | 1 593 | 1 000 | 2 399 | 3 000 | 7 400 | 8 650 | 8 650 |
| 152 | 1 000 | 1 600 | 1 050 | 2 454 | 3 000 | 7 600 | 8 807 | 8 807 |
| ^a 155 | 1 000 | 1 617 | 1 100 | 2 508 | 3 000 | 7 800 | 8 964 | 8 964 |
| ^a 160 | 1 000 | 1 641 | 1 150 | 2 560 | 3 000 | 8 000 | 9 119 | 9 119 |
| ^a 165 | 1 000 | 1 664 | 1 200 | 2 611 | 3 000 | 8 200 | 9 273 | 9 273 |
| ^a 170 | 1 000 | 1 688 | 1 250 | 2 661 | 3 000 | 8 400 | 9 425 | 9 425 |
| ^a 175 | 1 000 | 1 711 | 1 300 | 2 710 | 3 000 | 8 600 | 9 577 | 9 577 |
| ^a 180 | 1 000 | 1 733 | 1 350 | 2 758 | 3 000 | 8 800 | 9 727 | 9 727 |
| ^a 184 | 1 000 | 1 751 | 1 400 | 2 805 | 3 000 | 9 000 | 9 876 | 9 876 |
| 185 | 1 097 | 1 755 | 1 410 | 2 814 | 3 000 | 9 200 | 10 024 | 10 024 |
| 190 | 1 111 | 1 777 | 1 450 | 2 868 | 3 000 | 9 400 | 10 171 | 10 171 |
| 200 | 1 137 | 1 820 | 1 500 | 2 934 | 3 000 | 9 600 | 10 317 | 10 317 |
| 210 | 1 163 | 1 861 | 1 550 | 3 000 | 3 000 | 9 800 | 10 463 | 10 463 |
| 220 | 1 189 | 1 902 | 1 600 | 3 065 | 3 065 | 10 000 | 10 607 | 10 607 |
| 230 | 1 214 | 1 942 | 1 650 | 3 130 | 3 130 | | | |
| 240 | 1 238 | 1 980 | 1 700 | 3 194 | 3 194 | | | |

Linear interpolation is permitted between the nearest two points.

^a At these voltages, the values of *V_b* are determined by the general curve $V_b = 155,86 U^{0,4638}$ and are not 1,6 *V_a*.

Table 5C – Test voltages for electric strength tests based on required withstand voltages

| REQUIRED WITHSTAND VOLTAGE up to and including kV peak | Test voltage for FUNCTIONAL, BASIC OR SUPPLEMENTARY INSULATION | Test voltage for REINFORCED INSULATION |
|--|--|---|
| | kV peak or d.c. | |
| 0,33 | 0,35 | 0,7 |
| 0,5 | 0,55 | 1,1 |
| 0,8 | 0,9 | 1,8 |
| 1,5 | 1,5 | 3 |
| 2,5 | 2,5 | 5 |
| 4,0 | 4,0 | 8 |
| 6,0 | 6,0 | 10 |
| 8,0 | 8,0 | 13 |
| 12 | 12 | 19 |
| U^a | $1,0 \times U$ | $1,6 \times U$ |

Linear interpolation is permitted between the nearest two points.

If FUNCTIONAL INSULATION is tested (as required by 5.3.4 b), the test voltage for a WORKING VOLTAGE up to and including 42,4 V peak or 60 V d.c. shall not exceed 707 V peak or d.c. For a higher WORKING VOLTAGE, the test voltage given in Table 5B or Table 5C is used.

^a U is any REQUIRED WITHSTAND VOLTAGE higher than 12,0 kV.

5.3 Abnormal operating and fault conditions

5.3.1 Protection against overload and abnormal operation

Equipment shall be so designed that the risk of fire or electric shock due to mechanical or electrical overload or failure, or due to abnormal operation or careless use, is limited as far as practicable.

After abnormal operation or a single fault (see 1.4.14), the equipment shall remain safe for an OPERATOR in the meaning of this standard, but it is not required that the equipment should still be in full working order. It is permitted to use fusible links, THERMAL CUT-OUTS, overcurrent protection devices and the like to provide adequate protection.

Compliance is checked by inspection and by the tests of 5.3. Before the start of each test, it is checked that the equipment is operating normally.

If a component or subassembly is so enclosed that short-circuiting or disconnection as specified in 5.3 is not practicable or is difficult to perform without damaging the equipment, it is permitted to make the tests on sample parts provided with special connecting leads. If this is not possible or not practical, the component or subassembly as a whole shall pass the tests.

Equipment is tested by applying any condition that may be expected in normal use and foreseeable misuse.

In addition, equipment that is provided with a protective covering, is tested with the covering in place under normal idling conditions until steady conditions are established.

5.3.2 Motors

Under overload, locked rotor and other abnormal conditions, motors shall not create a hazard due to excessive temperatures.

NOTE Methods of achieving this include the following:

- the use of motors that do not overheat under locked-rotor conditions (protection by inherent or external impedance);
- the use in SECONDARY CIRCUITS of motors that may exceed the permitted temperature limits but that do not create a hazard;
- the use of a device responsive to motor current;
- the use of an integral THERMAL CUT-OUT;
- the use of a sensing circuit that disconnects power from the motor in a sufficiently short time to prevent overheating if, for example, the motor fails to perform its intended function.

Compliance is checked by the applicable test of Annex B.

5.3.3 Transformers

Transformers shall be protected against overload, for example, by

- overcurrent protection,
- internal THERMAL CUT-OUTS, or
- use of current limiting transformers.

Compliance is checked by the applicable tests of Clause C.1.

5.3.4 Functional insulation

For FUNCTIONAL INSULATION, CLEARANCES and CREEPAGE DISTANCES shall satisfy one of the following requirements a) or b) or c).

For insulation between a SECONDARY CIRCUIT and an inaccessible conductive part that is earthed for functional reasons, CLEARANCES and CREEPAGE DISTANCES shall satisfy a) or b) or c).

- a) They meet the CLEARANCE and CREEPAGE DISTANCE requirements for FUNCTIONAL INSULATION in 2.10 (or Annex G).
- b) They withstand the electric strength tests for FUNCTIONAL INSULATION in 5.2.2.
- c) They are short-circuited where a short-circuit could cause
 - overheating of any material creating a risk of fire, unless the material that could be overheated is of V-1 CLASS MATERIAL, or
 - thermal damage to BASIC INSULATION, SUPPLEMENTARY INSULATION OR REINFORCED INSULATION, thereby creating a risk of electric shock.

Compliance criteria for 5.3.4 c) are in 5.3.9.

5.3.5 Electromechanical components

Where a hazard is likely to occur, electromechanical components other than motors are checked for compliance with 5.3.1 by applying the following conditions:

- *mechanical movement shall be locked in the most disadvantageous position while the component is energized normally; and*

- *in the case of a component that is normally energized intermittently, a fault shall be simulated in the drive circuit to cause continuous energizing of the component.*

The duration of each test shall be as follows:

- *for equipment or components whose failure to operate is not evident to the OPERATOR: as long as necessary to establish steady conditions or up to the interruption of the circuit due to other consequences of the simulated fault condition, whichever is the shorter; and*
- *for other equipment and components: 5 min or up to interruption of the circuit due to a failure of the component (for example, burn-out) or to other consequences of the simulated fault condition, whichever is the shorter.*

For compliance criteria see 5.3.9.

5.3.6 Audio amplifiers in information technology equipment

Equipment having audio amplifiers shall be tested in accordance with 4.3.4 and 4.3.5 of IEC 60065. The equipment shall be operating normally before the tests are conducted.

5.3.7 Simulation of faults

For components and circuits other than those covered by 5.3.2, 5.3.3, 5.3.5 and 5.3.6, compliance is checked by simulating single fault conditions (see 1.4.14).

Ⓢ Note deleted **Ⓢ**

The following faults are simulated.

- Short-circuit or disconnection of any components in PRIMARY CIRCUITS.*
- Short-circuit or disconnection of any components where failure could adversely affect SUPPLEMENTARY INSULATION or REINFORCED INSULATION.*
- Short-circuit, disconnection or overloading of all relevant components and parts unless they comply with the requirements of 4.7.3.*

NOTE 2 An overload condition is any condition between NORMAL LOAD and maximum current condition up to short-circuit.

- Faults arising from connection of the most unfavourable load impedance to terminals and connectors that deliver power from the equipment, other than mains power outlets.*
- Other single faults specified in 1.4.14.*

Where there are multiple outlets having the same internal circuitry, the test is only made on one sample outlet.

For components in PRIMARY CIRCUITS associated with the mains input, such as the supply cord, appliance couplers, EMC filtering components, switches and their interconnecting wiring, no fault is simulated, provided that the component complies with 5.3.4 a) or 5.3.4 b).

NOTE 3 Such components are still subject to other requirements of this standard where applicable, including 1.5.1, 2.10.5, 4.7.3 and 5.2.2.

In addition to the compliance criteria given in 5.3.9, temperatures in the transformer supplying the component under test shall not exceed those specified in Clause C.1, and account shall be taken of the exception detailed in Clause C.1 regarding transformers that would require replacement.

5.3.8 Unattended equipment

Equipment intended for unattended use and having THERMOSTATS, TEMPERATURE LIMITERS and THERMAL CUT-OUTS, or having a capacitor not protected by a fuse or the like connected in parallel with the contacts, is subjected to the following tests.

THERMOSTATS, TEMPERATURE LIMITERS and THERMAL CUT-OUTS are also assessed for compliance with the requirements in Clause K.6.

Equipment is operated under the conditions specified in 4.5.2 and any control that serves to limit the temperature is short-circuited. If the equipment is provided with more than one THERMOSTAT, TEMPERATURE LIMITER or THERMAL CUT-OUT, each is short-circuited, one at a time.

If interruption of the current does not occur, the equipment is switched off as soon as steady conditions are established and is permitted to cool down to approximately room temperature.

For equipment not intended for continuous operation, the test is repeated until the temperature has stabilized, regardless of any marking of RATED OPERATING TIME or RATED RESTING TIME. For this test the THERMOSTATS, TEMPERATURE LIMITERS and THERMAL CUT-OUTS are not short-circuited.

If in any test a MANUAL RESET THERMAL CUT-OUT operates, or if the current is otherwise interrupted before the temperature has stabilized, the heating period is taken to have ended; but if the interruption is due to the rupture of an intentionally weak part, the test is repeated on a second sample. Both samples shall comply with the conditions specified in 5.3.9.

5.3.9 Compliance criteria for abnormal operating and fault conditions

5.3.9.1 During the tests

During the tests of 5.3.4 c), 5.3.5, 5.3.7, 5.3.8 and Clause C.1:

- if a fire occurs, it shall not propagate beyond the equipment; and*
- the equipment shall not emit molten metal; and*
- ENCLOSURES shall not deform in such a way as to cause non-compliance with 2.1.1, 2.6.1, 2.10.3 (or Annex G) and 4.4.1.*

Moreover, during the tests of 5.3.7 c), unless otherwise specified, the temperatures of insulating materials other than thermoplastic materials shall not exceed those in Table 5D.

Table 5D – Temperature limits for overload conditions

| Maximum temperature °C | | | | | | | |
|--|---------|---------|---------|---------|-----|-----|-----|
| Thermal class | | | | | | | |
| 105 (A) | 120 (E) | 130 (B) | 155 (F) | 180 (H) | 200 | 220 | 250 |
| 150 | 165 | 175 | 200 | 225 | 245 | 265 | 295 |
| The designations A to H, formerly assigned in IEC 60085 to thermal classes 105 to 180, are given in parentheses. | | | | | | | |

If the failure of the insulation would not result in HAZARDOUS VOLTAGES or HAZARDOUS ENERGY LEVELS becoming accessible, a maximum temperature of 300 °C is permitted. Higher temperatures are permitted for insulation made of glass or ceramic material.

5.3.9.2 After the tests

After the tests of 5.3.4 c), 5.3.5, 5.3.7 and 5.3.8 and Clause C.1, an electric strength test according to 5.2.2 is made on:

- *REINFORCED INSULATION; and*
- *BASIC INSULATION or SUPPLEMENTARY INSULATION forming part of DOUBLE INSULATION; and*
- *BASIC INSULATION between the PRIMARY CIRCUIT and the main protective earthing terminal;*

if any of the following applies:

- *the CLEARANCE or CREEPAGE DISTANCE has been reduced below the value specified in 2.10 (or Annex G); or*
- *the insulation shows visible signs of damage; or*
- *the insulation cannot be inspected.*

6 Connection to telecommunication networks

If the equipment is to be connected to a TELECOMMUNICATION NETWORK, the requirements of Clause 6 apply in addition to the requirements of Clauses 1 to 5 in this standard.

NOTE 1 It is assumed that adequate measures according to ITU-T Recommendation K.11 have been taken to reduce the likelihood that the overvoltages presented to the equipment exceed 1,5 kV peak. In installations where overvoltages presented to the equipment may exceed 1,5 kV peak, additional measures such as surge suppression may be necessary.

Ⓢ Note deleted Ⓢ

NOTE 3 The requirements of 2.3.2, 6.1.2 and 6.2 can apply to the same physical insulation or CLEARANCE.

NOTE 4 The AC MAINS SUPPLY system, if used as a communication transmission medium, is not a TELECOMMUNICATION NETWORK (see 1.2.13.8), and Clause 6 does not apply. The other clauses of this standard will apply to coupling components, such as signal transformers, connected between the mains and other circuitry. The requirements for DOUBLE INSULATION or REINFORCED INSULATION will generally apply. See also IEC 60664-1 and Annex Z of this standard for overvoltages to be expected at various points in the AC MAINS SUPPLY system.

Ⓢ Note deleted Ⓢ

6.1 Protection of telecommunication network service persons, and users of other equipment connected to the network, from hazards in the equipment

6.1.1 Protection from hazardous voltages

Circuitry intended to be directly connected to a TELECOMMUNICATION NETWORK shall comply with the requirements for an SELV CIRCUIT or a TNV CIRCUIT.

Where protection of the TELECOMMUNICATION NETWORK relies on the protective earthing of the equipment, the installation instructions and other relevant literature shall state that integrity of protective earthing shall be ensured, see also 1.7.2.1.

Compliance is checked by inspection and measurement.

6.1.2 Separation of the telecommunication network from earth

6.1.2.1 Requirements

Except as specified in 6.1.2.2, there shall be insulation between circuitry intended to be connected to a TELECOMMUNICATION NETWORK and any parts or circuitry that will be earthed in some applications, either within the EUT or via other equipment.

Surge suppressors that bridge the insulation shall have a minimum rated operating voltage U_{op} (for example, the sparkover voltage of a gas discharge tube) of

$$U_{op} = U_{peak} + \Delta U_{sp} + \Delta U_{sa}$$

where

U_{peak} is one of the following values:

for equipment intended to be installed in an area where the nominal voltage of the AC MAINS SUPPLY exceeds 130 V: 360 V

for all other equipment: 180 V.

ΔU_{sp} is the maximum increase of the rated operating voltage due to variations in component production. If this is not specified by the component manufacturer, ΔU_{sp} shall be taken as 10 % of the rated operating voltage of the component.

ΔU_{sa} is the maximum increase of the rated operating voltage due to the component ageing over the expected life of the equipment. If this is not specified by the component manufacturer, ΔU_{sa} shall be taken as 10 % of the rated operating voltage of the component.

NOTE 1 ($\Delta U_{sp} + \Delta U_{sa}$) may be a single value provided by the component manufacturer.

Compliance is checked by inspection and by the following tests. The dimensional and construction requirements of 2.10 and Annex G do not apply for compliance with 6.1.2.

Ⓒ Note deleted Ⓒ

Insulation is subjected to an electric strength test according to 5.2.2. The a.c. test voltage is as follows:

- for equipment intended to be installed in an area where the nominal AC MAINS SUPPLY voltage exceeds 130 V: 1,5 kV
- for all other equipment: 1,0 kV.

The test voltages apply whether or not the equipment is powered from the AC MAINS SUPPLY.

Components bridging the insulation that are left in place during electric strength testing shall not be damaged. There shall be no breakdown of insulation during electric strength testing.

It is permitted to remove components that bridge the insulation, other than capacitors, during electric strength testing.

If this option is chosen, an additional test with a test circuit according to Figure 6A is performed with all components in place.

For equipment powered from an AC MAINS SUPPLY, the test is performed with a voltage equal to the RATED VOLTAGE of the equipment or to the upper voltage of the RATED VOLTAGE RANGE. For equipment powered from a DC MAINS SUPPLY, the test is performed with a voltage equal to the highest nominal voltage of the AC MAINS SUPPLY in the region where the equipment is to be used, for example, 230 V for Europe or 120 V for North America.

The current flowing in the test circuit of Figure 6A shall not exceed 10 mA.

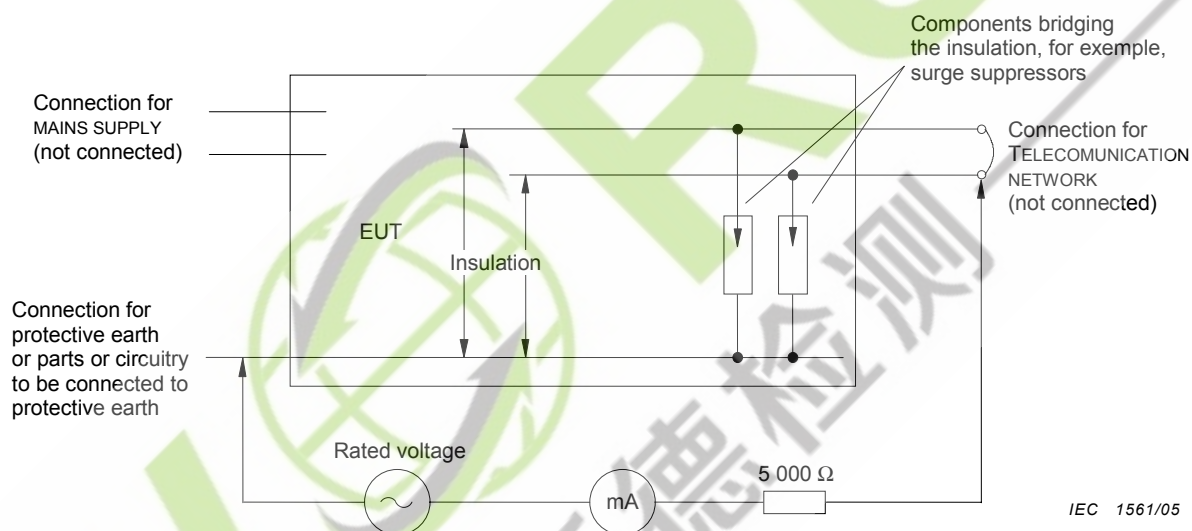

Figure 6A – Test for separation between a telecommunication network and earth

6.1.2.2 Exclusions

The requirements of 6.1.2.1 do not apply to any of the following:

- PERMANENTLY CONNECTED EQUIPMENT OR PLUGGABLE EQUIPMENT TYPE B;
- equipment that is intended to be installed by a SERVICE PERSON and has installation instructions that require the equipment to be connected to a socket-outlet with a protective earthing connection (see 6.1.1);
- equipment that has provision for a permanently connected PROTECTIVE EARTHING CONDUCTOR and is provided with instructions for the installation of that conductor.

Ⓒ Note deleted Ⓒ

6.2 Protection of equipment users from overvoltages on telecommunication networks

6.2.1 Separation requirements

Equipment shall provide adequate electrical separation between a TNV-1 CIRCUIT or a TNV-3 CIRCUIT and the following parts of the equipment.

- Unearthed conductive parts and non-conductive parts of the equipment expected to be held or touched during normal use (for example, a telephone handset a keyboard or the entire exterior surface of a laptop or notebook computer).
- Parts and circuitry that can be touched by the test finger, Figure 2A (see 2.1.1.1), except contacts of connectors that cannot be touched by the test probe, Figure 2C (see 2.1.1.1).
- An SELV CIRCUIT, a TNV-2 CIRCUIT or a LIMITED CURRENT CIRCUIT provided for connection of other equipment. The requirement for separation applies whether or not this circuit is accessible.

These requirements do not apply where circuit analysis and equipment investigation indicate that adequate protection is assured by other means, for example, between two circuits each of which has a permanent connection to protective earth.

Compliance is checked by inspection and by the tests of 6.2.2. The dimensional and constructional requirements of 2.10 and Annex G do not apply for compliance with 6.2.1.

NOTE The requirements of 2.10 and Annex G may apply for compliance with 2.2 and 2.3. See Footnote e and Footnote f of Table 2H.

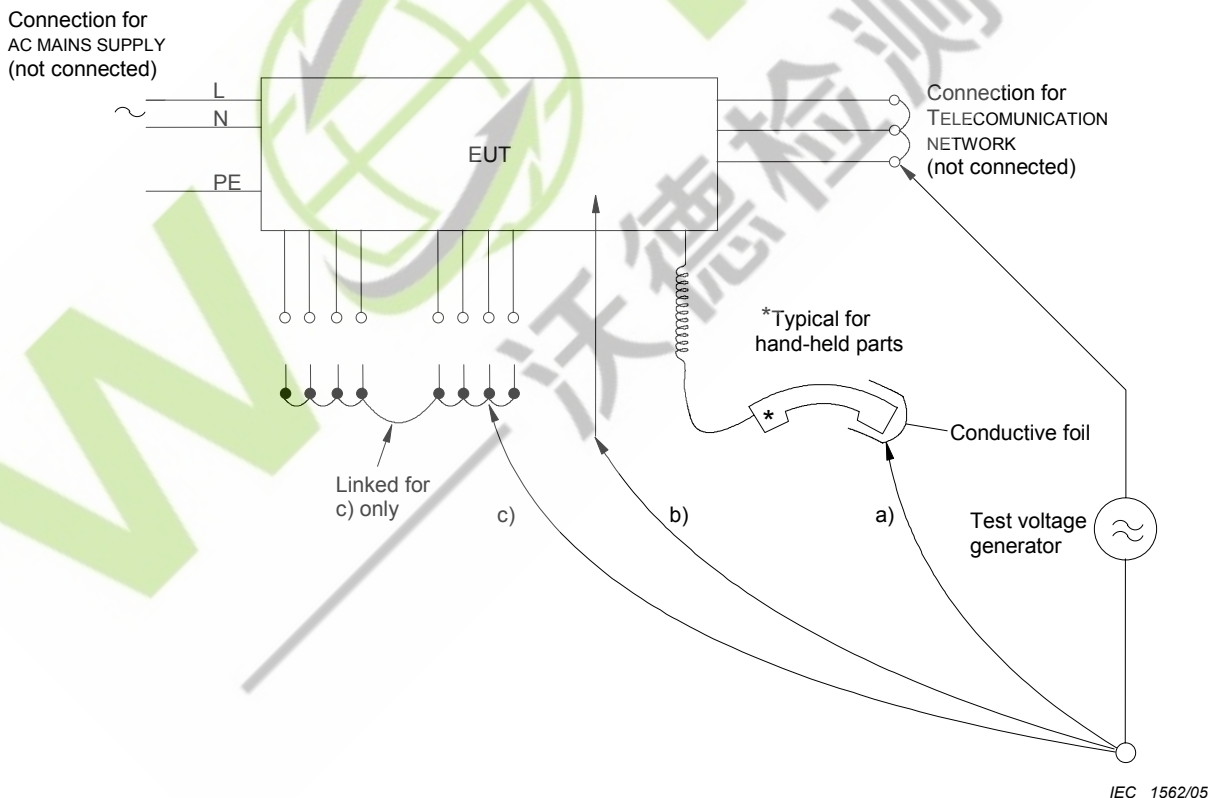

Figure 6B – Application points of test voltage

6.2.2 Electric strength test procedure

Compliance with 6.2.1 is checked by the test of either 6.2.2.1 or 6.2.2.2.

Ⓢ Note deleted Ⓢ

If a test is applied to a component (see 1.4.3), for example, a signal transformer, which is clearly intended to provide the separation required, the component shall not be bypassed by other components, mounting devices or wiring, unless these components or wiring also meet the separation requirements of 6.2.

For the tests, all conductors intended to be connected to the TELECOMMUNICATION NETWORK are connected together (see Figure 6B), including any conductors required by the TELECOMMUNICATION NETWORK authority to be connected to earth. Similarly, all conductors intended to be connected to other equipment are connected together for testing related to 6.2.1 c).

Non-conductive parts are tested with metal foil in contact with the surface. Where adhesive metal foil is used, the adhesive shall be conductive.

6.2.2.1 Impulse test

The electrical separation is subjected to ten impulses of alternating polarity, using the impulse test generator reference 1 of Table N.1. The interval between successive impulses is 60 s and U_c is equal to:

- for 6.2.1 a): 2,5 kV; and
- for 6.2.1 b) and 6.2.1 c): 1,5 kV.

NOTE 1 The value of 2,5 kV for 6.2.1 a) has been chosen primarily to ensure the adequacy of the insulation concerned and it does not necessarily simulate likely overvoltages.

Ⓢ Note deleted Ⓢ

6.2.2.2 Steady-state test

The electrical separation is subjected to an electric strength test according to 5.2.2.

The a.c. test voltage is:

- for 6.2.1 a): 1,5 kV; and
- for 6.2.1 b) and 6.2.1 c): 1,0 kV.

Ⓢ Note deleted Ⓢ

For 6.2.1 b) and 6.2.1 c), it is permitted to remove surge suppressors, provided that such devices pass the impulse test of 6.2.2.1 for 6.2.1 b) and 6.2.1 c) when tested as components outside the equipment. For 6.2.1 a), surge suppressors shall not be removed.

6.2.2.3 Compliance criteria

During the tests of 6.2.2.1 and 6.2.2.2, there shall be no breakdown of insulation.

Insulation breakdown is considered to have occurred when the current that flows as a result of the application of the test voltage rapidly increases in an uncontrolled manner, that is the insulation does not restrict the flow of current.

If a surge suppressor operates (or sparkover occurs within a gas discharge tube) during the test:

- *for 6.2.1 a), such operation represents a failure; and*
- *for 6.2.1 b) and 6.2.1 c), such operation is permitted during the impulse test; and*
- *for 6.2.1 b) and 6.2.1 c), such operation during the electric strength test (by any surge suppressor left in place) represents a failure.*

For impulse tests, damage to insulation is verified in one of two ways, as follows:

- *during the application of the impulses, by observation of oscillograms. Surge suppressor operation or breakdown through insulation is judged from the shape of an oscillogram.*
- *after application of all the impulses, by an insulation resistance test. Disconnection of surge suppressors is permitted while insulation resistance is being measured. The test voltage is 500 V d.c. or, if surge suppressors are left in place, a d.c. test voltage that is 10 % less than the surge suppressor operating or striking voltage. The insulation resistance shall not be less than 2 M Ω .*

NOTE A description of procedures to judge whether a surge suppressor operation or breakdown of insulation has occurred, using oscillograms, is given in Annex S.

6.3 Protection of the telecommunication wiring system from overheating

Equipment intended to provide power over the telecommunication wiring system to remote equipment shall limit the output current to a value that does not cause damage to the telecommunication wiring system, due to overheating, under any external load condition. The maximum continuous current from equipment shall not exceed a current limit that is suitable for the minimum wire gauge specified in the equipment installation instructions. The current limit is 1,3 A if such wiring is not specified.

NOTE 1 The overcurrent protective device may be a discrete device such as a fuse, or a circuit that performs that function.

NOTE 2 The minimum wire diameter normally used in telecommunication wiring is 0,4 mm, for which the maximum continuous current for a multipair cable is 1,3 A. This wiring is not usually controlled by the equipment installation instructions, since the wiring is often installed independent of the equipment installation.

NOTE 3 Further current limitation may be necessary for equipment intended for connection to networks that are subject to overvoltages, due to operating parameters for protective devices.

Compliance is checked as follows.

If current limiting is due to the inherent impedance of the power source, the output current into any resistive load, including a short-circuit, is measured. The current limit shall not be exceeded after 60 s of test.

If current limiting is provided by an overcurrent protective device having a specified time/current characteristic:

- *the time/current characteristic shall show that a current equal to 110 % of the current limit will be interrupted within 60 min; and*

NOTE 4 Time/current characteristics of type gD and type gN fuses specified in IEC 60269-2-1 comply with the above limit. Type gD or type gN fuses rated 1 A, would meet the 1,3 A current limit.

- *the output current into any resistive load, including a short-circuit, with the overcurrent protective device bypassed, measured after 60 s of test, shall not exceed 1 000/U, where U is the output voltage measured in accordance with 1.4.5 with all load circuits disconnected.*

If current limiting is provided by an overcurrent protective device that does not have a specified time/current characteristic:

- the output current into any resistive load, including a short-circuit, shall not exceed the current limit after 60 s of test; and
- the output current into any resistive load, including a short-circuit, with the overcurrent protective device bypassed, measured after 60 s of test, shall not exceed $1\ 000/U$, where U is the output voltage measured in accordance with 1.4.5 with all load circuits disconnected.

7 Connection to cable distribution systems

7.1 General



If the equipment is to be connected to a CABLE DISTRIBUTION SYSTEM, the requirements of Clause 7 apply in addition to the requirements of Clauses 1 to 5 of this standard.

NOTE 1 Unless the connection uses coaxial cable, the circuit is not a CABLE DISTRIBUTION SYSTEM, and Clause 6 applies.

NOTE 2 It is assumed that adequate measures have been taken to reduce the likelihood that transient overvoltages presented to the equipment exceed the following values:

- 10 kV for equipment to be connected only to an outdoor antenna;
- 4 kV to other equipment, see ITU-T Recommendations K.20, K.21 and K.45.

In installations where overvoltages presented to the equipment may exceed these values, additional measures such as surge suppression may be necessary.

 Note deleted 

NOTE 4 The AC MAINS SUPPLY system, if used as a communication medium, is not a CABLE DISTRIBUTION SYSTEM (see 1.2.13.14) and Clause 7 does not apply. For equipment to be connected to such systems, the other clauses of this standard will apply to coupling components, such as signal transformers and capacitors, connected between the mains and other circuitry. The requirements for DOUBLE INSULATION or REINFORCED INSULATION will generally apply. See also Annex Z of this standard and IEC 60664-1 for overvoltages to be expected at various points in the AC MAINS SUPPLY system.

NOTE 5 It is assumed that the cable shield will be earthed in accordance with the installation requirements of IEC 60728-11.

7.2 Protection of cable distribution system service persons, and users of other equipment connected to the system, from hazardous voltages in the equipment

Circuitry intended to be directly connected to a CABLE DISTRIBUTION SYSTEM shall comply with the requirements for a TNV-1 CIRCUIT, a TNV-3 CIRCUIT or a HAZARDOUS VOLTAGE SECONDARY CIRCUIT, depending on the normal operating voltage.

Where protection of the CABLE DISTRIBUTION SYSTEM relies on protective earthing of the equipment, the installation instructions and other relevant literature shall state that the integrity of the protective earth must be ensured, see also 1.7.2.1.

Compliance is checked by inspection and by measurement.

 Note deleted 

7.3 Protection of equipment users from overvoltages on the cable distribution system

The requirements and tests of 6.2 apply except that the term "TELECOMMUNICATION NETWORK" is replaced by "CABLE DISTRIBUTION SYSTEM" throughout 6.2. When applying 6.2 to CABLE DISTRIBUTION SYSTEMS, the separation requirements apply only to those circuit parts that are directly connected to the inner conductor (or conductors) of the coaxial cable; the separation requirements do not apply to those circuit parts that are directly connected to the outer screen or screens.

However, the separation requirements and tests of 6.2.1 a), b) and c) do not apply to a CABLE DISTRIBUTION SYSTEM if all of the following apply:

- the circuit under consideration is a TNV-1 CIRCUIT; and
- the common or earthed side of the circuit is connected to the screen of the coaxial cable and to all accessible parts and circuits (SELV, accessible metal parts and LIMITED CURRENT CIRCUITS, if any); and
- the screen of the coaxial cable is intended to be connected to earth in the building installation.

Ⓒ Note deleted Ⓒ

Compliance is checked by inspection and the application of the relevant requirements and tests of 6.2.

7.4 Insulation between primary circuits and cable distribution systems

7.4.1 General

Except as specified below, the insulation between the PRIMARY CIRCUIT and the terminal or lead provided for the connection of a CABLE DISTRIBUTION SYSTEM shall pass either:

- the voltage surge test of 7.4.2 for equipment intended to be connected to outdoor antennas; or
- the impulse test of 7.4.3 for equipment intended to be connected to other CABLE DISTRIBUTION SYSTEMS.

If an equipment is intended for connection to both an outdoor antenna and another CABLE DISTRIBUTION SYSTEM, it shall pass the tests of 7.4.2 and 7.4.3.

The above requirement does not apply to any of the following:

- equipment intended for indoor use only, provided with a built in (integral) antenna and not provided with a connection to a CABLE DISTRIBUTION SYSTEM;
- PERMANENTLY CONNECTED EQUIPMENT OR PLUGGABLE EQUIPMENT TYPE B, in which the circuit intended to be connected to the CABLE DISTRIBUTION SYSTEM is also connected to protective earth in accordance with 2.6.1 e);
- PLUGGABLE EQUIPMENT TYPE A, in which the circuit intended to be connected to the CABLE DISTRIBUTION SYSTEM is also connected to protective earth in accordance with 2.6.1 e); and either
 - is intended to be installed by a SERVICE PERSON and has installation instructions that require the equipment to be connected to a socket-outlet with a protective earthing connection; or
 - has provision for a permanently connected PROTECTIVE EARTHING CONDUCTOR, including instructions for the installation of that conductor.

Compliance is checked by inspection and, if necessary, by the voltage surge test of 7.4.2 or the impulse test of 7.4.3.

NOTE Minimum CLEARANCES are determined by the requirements of 2.10.3 (or Annex G). It may be necessary to increase the CLEARANCES between PRIMARY CIRCUITS and SECONDARY CIRCUITS intended for connection to CABLE DISTRIBUTION SYSTEMS so that the circuits can pass the tests of 7.4.2 or 7.4.3.

7.4.2 Voltage surge test

The test is applied between the supply circuit terminals and the main protective earthing terminal, if any, joined together, and the connection points for the CABLE DISTRIBUTION SYSTEM, excluding any earthed conductor, joined together. All components connected between the connection points for the CABLE DISTRIBUTION SYSTEM and the main protective earthing terminal are disconnected before the test. If an on/off switch is provided, it is in the "ON" position.

Conditioning pulses are applied between

- the connection points for the CABLE DISTRIBUTION SYSTEM, excluding any earthed conductor, joined together, and
- the supply circuit terminals and the main protective earthing terminal, if any, joined together.

Fifty discharges are applied from the impulse test generator reference 3 of Table N.1, at a maximum rate of 12 pulses per minute, with U_c equal to 10 kV.

After the above conditioning, the relevant electric strength tests of 5.2.2 are applied.

7.4.3 Impulse test

The test is applied between the supply circuit terminals and the main protective earthing terminal, if any, joined together, and the connection points for the CABLE DISTRIBUTION SYSTEM, excluding any earthed conductor, joined together. All components connected between the connection points for the CABLE DISTRIBUTION SYSTEM and the main protective earthing terminal are disconnected before the test. If an on/off switch is provided, it is in the "ON" position.

Ten conditioning pulses of alternating polarity are applied from the impulse test generator reference 1 of Table N.1. The interval between successive pulses is 60 s, and U_c is equal to

- 5 kV for power-fed repeaters;
- 4 kV for all other terminal and network equipment.

After the above conditioning, the relevant electric strength tests of 5.2.2 are applied.

Annex A (normative)

Tests for resistance to heat and fire

It should be noted that toxic fumes may be given off during the tests. Where appropriate the tests should be conducted either under a ventilated hood or in a well-ventilated room, but free from draughts that could invalidate the tests.

A.1 Flammability test for fire enclosures of movable equipment having a total mass exceeding 18 kg and of stationary equipment (see 4.7.3.2)

A.1.1 Samples

Three samples, each consisting of either a complete FIRE ENCLOSURE or a section of the FIRE ENCLOSURE representing the thinnest significant wall thickness and including any ventilation opening, are tested.

A.1.2 Conditioning of samples

Prior to being tested, the samples are conditioned in a circulating air oven for a period of 7 days (168 h), at a uniform temperature 10 K higher than the maximum temperature reached by the material measured during the test of 4.5.2, or 70 °C, whichever is the higher, and then cooled to room temperature.

A.1.3 Mounting of samples

Samples are mounted as they would be in actual use. A layer of untreated surgical cotton is located 300 mm below the point of application of the test flame.

A.1.4 Test flame

The test flame according to IEC 60695-11-3 is used.

A.1.5 Test procedure

The test flame is applied to an inside surface of the sample, at a location judged to be likely to become ignited because of its proximity to a source of ignition. If a vertical part is involved, the flame is applied at an angle of approximately 20° from the vertical. If ventilation openings are involved, the flame is applied to an edge of an opening, otherwise to a solid surface. In all cases, the tip of the inner blue cone is to be in contact with the sample. The flame is applied for 5 s and removed for 5 s. This operation is repeated, whether or not the sample is flaming, until the sample has been subjected to five applications of the test flame to the same location.

The test is repeated on the remaining two samples. If more than one part of the FIRE ENCLOSURE is near a source of ignition, each sample is tested with the flame applied to a different location.

A.1.6 Compliance criteria

During the test, the sample shall not release either flaming drops or particles capable of igniting the surgical cotton. The sample shall not continue to burn for more than 1 min after the fifth application of the test flame, and shall not be consumed completely.

A.2 Flammability test for fire enclosures of movable equipment having a total mass not exceeding 18 kg, and for material and components located inside fire enclosures (see 4.7.3.2 and 4.7.3.4)

A.2.1 Samples

Three samples are tested. For FIRE ENCLOSURES, each sample consists of either a complete FIRE ENCLOSURE or a section of the FIRE ENCLOSURE representing the thinnest significant wall thickness and including any ventilation opening. For material to be located within the FIRE ENCLOSURE, each sample of the material consists of one of the following:

- the complete part; or*
- a section of the part representing the thinnest significant wall thickness; or*
- a test plaque or bar of uniform thickness representing the thinnest significant section of the part.*

For components to be located within the FIRE ENCLOSURE, each sample is to be a complete component.

A.2.2 Conditioning of samples

Prior to being tested, the samples are conditioned in a circulating air oven for a period of 7 days (168 h), at a uniform temperature 10 K higher than the maximum temperature of the part measured during the test of 4.5.2, or 70 °C, whichever is the higher, and then cooled to room temperature.

A.2.3 Mounting of samples

Samples are mounted and oriented as they would be in actual use.

A.2.4 Test flame

The test flame according to IEC 60695-11-4 is used.

A.2.5 Test procedure

The test flame is applied to an inside surface of the sample at a point judged to be likely to become ignited because of its proximity to a source of ignition. For the evaluation of materials located within the FIRE ENCLOSURE, it is permitted to apply the test flame to an external surface of the sample. For the evaluation of components to be located within the FIRE ENCLOSURE, the test flame is applied directly to the component.

If a vertical part is involved, the flame is applied at an angle of approximately 20° from the vertical. If ventilation openings are involved, the flame is applied to an edge of an opening, otherwise to a solid surface. In all cases, the tip of the flame is to be in contact with the sample. The flame is applied for 30 s and removed for 60 s, then reapplied to the same location for 30 s, whether or not the sample is flaming.

The test is repeated on the remaining two samples. If any part being tested is near a source of ignition at more than one point, each sample is tested with the flame applied to a different point that is near a source of ignition.

A.2.6 Compliance criteria

During the test, the samples shall not continue to burn for more than 1 min after the second application of the test flame, and shall not be consumed completely.

A.2.7 Alternative test

As an alternative to the apparatus and procedure specified in A.2.4 and A.2.5, it is permitted to use the apparatus and procedure specified in Clauses 5 and 9 of IEC 60695-11-5. The manner, duration and number of flame applications are as specified in A.2.5 and compliance is in accordance with A.2.6.

NOTE Compliance with the method of either A.2.4 and A.2.5 or of A.2.7 is acceptable; it is not required to comply with both methods.

A.3 Hot flaming oil test (see 4.6.2)

A.3.1 Mounting of samples

A sample of the complete finished bottom of the FIRE ENCLOSURE is securely supported in a horizontal position. Bleached CHEESECLOTH of approximately 40 g/m² is placed in one layer over a shallow, flat-bottomed pan approximately 50 mm below the sample, and is of sufficient size to cover completely the pattern of openings in the sample, but not large enough to catch any of the oil that runs over the edge of the sample or otherwise does not pass through the openings.

NOTE Use of a metal screen or a wired-glass partition surrounding the test area is recommended.

A.3.2 Test procedure

A small metal ladle (preferably no more than 65 mm in diameter), with a pouring lip and a long handle whose longitudinal axis remains horizontal during pouring, is partially filled with 10 ml of a distillate fuel oil that is a medium volatile distillate having a mass per unit volume between 0,845 g/ml and 0,865 g/ml, a flash point between 43,5 °C and 93,5 °C and an average calorific value of 38 MJ/l. The ladle containing the oil is heated and the oil ignited and permitted to burn for 1 min, at which time all of the hot flaming oil is poured at the rate of approximately 1 ml/s in a steady stream onto the centre of the pattern of openings, from a position approximately 100 mm above the openings.

The test is repeated twice at 5 min intervals, using clean CHEESECLOTH.

A.3.3 Compliance criterion

During these tests the CHEESECLOTH shall not ignite.

Annex B (normative)

Motor tests under abnormal conditions

(see 4.7.2.2 and 5.3.2)

B.1 General requirements

Motors, other than d.c. motors in SECONDARY CIRCUITS, shall pass the tests of Clauses B.4 and B.5 and, where applicable, Clauses B.8, B.9 and B.10, except that the following motors are not required to pass the test of Clause B.4:

- *motors that are used for air-handling only and where the air propelling component is directly coupled to the motor shaft; and*
- *shaded pole motors whose values of locked-rotor current and no-load current do not differ by more than 1 A and have a ratio of not more than 2/1.*

DC motors in SECONDARY CIRCUITS shall pass the tests of Clauses B.6, B.7 and B.10 except that motors, which by their intrinsic operation normally operate under locked-rotor conditions, such as stepper motors, are not tested.

B.2 Test conditions

Unless otherwise specified in this annex, during the test the equipment is operated at RATED VOLTAGE, or at the upper voltage of the RATED VOLTAGE RANGE.

The tests are conducted either in the equipment or under simulated conditions on the bench. It is permitted to use separate samples for bench tests. Simulated conditions include:

- *any protection devices that would protect the motor in the complete equipment; and*
- *use of any mounting means that may serve as a heat sink to the motor frame.*

Temperatures of windings are measured as specified in 1.4.13. Where thermocouples are used they are applied to the surface of the motor windings. Temperatures are determined at the end of the test period where specified, otherwise when the temperature has stabilized, or at the instant of operation of fuses, THERMAL CUT-OUTS, motor protection devices and the like.

For totally enclosed, impedance-protected motors, the temperatures are measured by thermocouples applied to the motor case.

When motors without inherent thermal protection are tested under simulated conditions on the bench, the measured winding temperature is adjusted to take into account the ambient temperature in which the motor is normally located within the equipment as measured during the test of 4.5.2.

B.3 Maximum temperatures

For the tests in Clauses B.5, B.7, B.8 and B.9, the temperature limits, as specified in Table B.1, shall not be exceeded for each class of insulating material.

Table B.1 – Temperature limits for motor windings (except for running overload test)

| Method of protection | Thermal class | | | | | | | |
|---|---------------|---------|---------|---------|---------|-----|-----|-----|
| | 105 (A) | 120 (E) | 130 (B) | 155 (F) | 180 (H) | 200 | 220 | 250 |
| Protection by inherent or external impedance | 150 | 165 | 175 | 200 | 225 | 245 | 265 | 295 |
| Protection by protective device that operates during the first hour | 200 | 215 | 225 | 250 | 275 | 295 | 315 | 345 |
| Protection by any protective device: | | | | | | | | |
| – maximum after first hour | 175 | 190 | 200 | 225 | 250 | 270 | 290 | 320 |
| – arithmetic average during the 2nd hour and during the 72nd hour | 150 | 165 | 175 | 200 | 225 | 245 | 265 | 295 |

Maximum temperature °C

The designations A to H, formerly assigned in IEC 60085 to thermal classes 105 to 180, are given in parentheses.

The arithmetic average temperature is determined as follows:

The graph of temperature against time (see Figure B.1), while the power to the motor is cycling on and off, is plotted for the period of test under consideration. The arithmetic average temperature (t_A) is determined by the formula:

$$t_A = \frac{t_{max} + t_{min}}{2}$$

where

t_{max} is the average of the maxima;

t_{min} is the average of the minima.

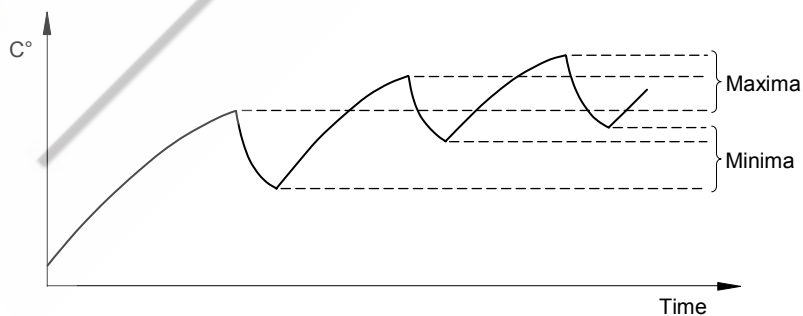

IEC 1563/05

Figure B.1 – Determination of arithmetic average temperature

For the tests in Clauses B.4 and B.6, the temperature limits, as specified in Table B.2, shall not be exceeded for each class of insulating material.

B.4 Running overload test

A running overload protection test is conducted by operating the motor under *NORMAL LOAD*. The load is then increased so that the current is increased in appropriate gradual steps, the motor supply voltage being maintained at its original value. When steady conditions are established, the load is again increased. The load is thus progressively increased in appropriate steps but without reaching locked-rotor condition (see Clause B.5), until the overload protection device operates.

The motor winding temperatures are determined during each steady period and the maximum temperature recorded shall not exceed the values specified in Table B.2.

Table B.2 – Permitted temperature limits for running overload tests

Maximum temperature °C

| Thermal class | | | | | | | |
|---------------|---------|---------|---------|---------|-----|-----|-----|
| 105 (A) | 120 (E) | 130 (B) | 155 (F) | 180 (H) | 200 | 220 | 250 |
| 140 | 155 | 165 | 190 | 215 | 235 | 255 | 275 |

The designations A to H, formerly assigned in IEC 60085 to thermal classes 105 to 180, are given in parentheses.

B.5 Locked-rotor overload test

A locked-rotor test is conducted starting at room temperature.

The duration of the test is as follows:

- a motor protected by inherent or external impedance is operated with its rotor locked for 15 days except that testing may be discontinued when the windings of the motor, of either the open or totally enclosed type, reach a constant temperature, provided that the constant temperature is not more than that specified in 4.5.3, Table 4B for the insulation system used;
- a motor with an automatic reset protection device is cycled with its rotor locked for 18 days;
- a motor with a manual reset protection device is cycled with its rotor locked for 60 cycles, the protection device being reset after each operation as soon as possible for it to remain closed, but after not less than 30 s;
- a motor with a non-resettable protection device is operated with its rotor locked until the device operates.

Temperatures are recorded at regular intervals during the first three days for a motor with inherent or external impedance protection or with an automatic reset protection device, or during the first ten cycles for a motor with a manual reset protection device, or at the time of operation of a non-resettable protection device.

The temperatures shall not exceed the values specified in Table B.1.

During the test, protective devices shall operate reliably without breakdown of insulation to the motor frame or permanent damage to the motor, including excessive deterioration of the insulation.

Permanent damage to the motor includes:

- severe or prolonged smoking or flaming;*
- electrical or mechanical breakdown of any associated component part such as a capacitor or starting relay;*
- flaking, embrittlement or charring of insulation.*

Discoloration of the insulation is permitted but charring or embrittlement to the extent that insulation flakes off or material is removed when the winding is rubbed with the thumb is not permitted.

After the period specified for temperature measurement, the motor shall withstand the electric strength test in 5.2.2 after the insulation has cooled to room temperature and with test voltages reduced to 60 % of the specified values. No further electric strength test is required.

NOTE Continuation of the test of an automatic reset protection device beyond 72 h, and of a manual reset protection device beyond 10 cycles, is for the purpose of demonstrating the capability of the device to make and break locked-rotor current for an extended period of time.

B.6 Running overload test for d.c. motors in secondary circuits

B.6.1 General

The running overload test is conducted only if a possibility of an overload occurring is determined by inspection or by review of the design. The test need not be conducted, for example, where electronic drive circuits maintain a substantially constant drive current.

Motors shall pass the test in B.6.2, except that, if difficulty is experienced in obtaining accurate temperature measurements, due to the small size or unconventional design of the motor, the method of B.6.3 can be used instead. Compliance may be established by either method.

B.6.2 Test procedure

The motor is operated under NORMAL LOAD. The load is then increased so that the current is increased in appropriate gradual steps, the motor supply voltage being maintained at its original value. When steady conditions are established the load is again increased. The load is thus progressively increased in appropriate steps until either the overload protection device operates or the winding becomes an open circuit.

The motor winding temperatures are determined during each steady period and the maximum temperature recorded shall not exceed the value in Table B.2.

B.6.3 Alternative test procedure

The motor is placed on a wooden board that is covered with a single layer of WRAPPING TISSUE, and the motor in turn is covered with a single layer of CHEESECLOTH.

At the conclusion of the test, there shall be no ignition of the WRAPPING TISSUE or CHEESECLOTH.

Compliance with either method is acceptable; it is not necessary to comply with both methods.

B.6.4 Electric strength test

Following the test of B.6.2 or B.6.3, as applicable, if the motor voltage exceeds 42,4 V peak, or 60 V d.c., and after it has cooled to room temperature, the motor shall withstand the electric strength test in 5.2.2, but with test voltages reduced to 60 % of the specified values.

B.7 Locked-rotor overload test for d.c. motors in secondary circuits

B.7.1 General

Motors shall pass the test in B.7.2, except that, where difficulty is experienced in obtaining accurate temperature measurements, due to the small size or unconventional design of the motor, the method of B.7.3 can be used instead. Compliance may be established by either method.

B.7.2 Test procedure

The motor is operated at the voltage used in its application and with its rotor locked for 7 h or until steady conditions are established, whichever is the longer. Temperatures shall not exceed the values specified in Table B.1.

B.7.3 Alternative test procedure

The motor is placed on a wooden board that is covered with a single layer of WRAPPING TISSUE, and the motor in turn covered with a single layer of bleached cotton CHEESECLOTH of approximately 40 g/m².

The motor is then operated at the voltage used in its application and with its rotor locked for 7 h or until steady conditions are established, whichever is the longer.

At the conclusion of the test there shall be no ignition of the WRAPPING TISSUE or CHEESECLOTH.

B.7.4 Electric strength test

Following the test of B.7.2 or B.7.3, as applicable, if the motor voltage exceeds 42,4 V peak, or 60 V d.c., and after it has cooled to room temperature, the motor shall withstand the electric strength test in 5.2.2 but with test voltages reduced to 60 % of the specified values.

B.8 Test for motors with capacitors

Motors having phase-shifting capacitors are tested under locked rotor conditions with the capacitor short-circuited or open-circuited (whichever is the more unfavourable).

The short-circuit test is not made if the capacitor is so designed that, upon failure, it will not remain short-circuited.

Temperatures shall not exceed the values specified in Table B.1.

NOTE Locked rotor is specified because some motors may not start and variable results could be obtained.

B.9 Test for three-phase motors

Three-phase motors are tested under NORMAL LOAD, with one line conductor disconnected, unless circuit controls prevent the application of voltage to the motor with one or more supply conductors disconnected.

The effect of other loads and circuits within the equipment may necessitate that the motor be tested within the equipment and with each of the three line conductors disconnected one at a time.

Temperatures shall not exceed the values specified in Table B.1.

B.10 Test for series motors

Series motors are operated at a voltage equal to 130 % of the motor voltage rating for 1 min with the lowest possible load.

After the test, windings and connections shall not have worked loose and no hazard shall be present in the meaning of this standard.

Annex C (normative)

Transformers

(see 1.5.4 and 5.3.3)

C.1 Overload test

If the tests in this clause are conducted under simulated conditions on the bench, these conditions shall include any protection device that would protect the transformer in the complete equipment.

Transformers for switch mode power supply units are tested in the complete power supply unit or in the complete equipment. Test loads are applied to the output of the power supply unit.

A linear transformer or a ferro-resonant transformer has each secondary winding loaded in turn, with any other secondaries loaded between zero and their specified maxima to result in the maximum heating effect.

The output of a switch mode power supply unit is loaded to result in the maximum heating effect in the transformer.

NOTE For examples of loading to give the maximum heating effect, see Annex X.

Where an overload cannot occur or is unlikely to create a hazard, the above tests are not made.

Maximum temperatures of windings shall not exceed the values in Table C.1 when measured as specified in 1.4.12 and 1.4.13, and determined as specified below:

- *with external overcurrent protection: at the moment of operation, for determination of the time until the overcurrent protection operates, it is permitted to refer to a data sheet of the overcurrent protection device showing the trip time versus the current characteristics;*
- *with an AUTOMATIC RESET THERMAL CUT-OUT: as shown in Table C.1 and after 400 h;*
- *with a MANUAL RESET THERMAL CUT-OUT: at the moment of operation;*
- *for current-limiting transformers: after temperature has stabilized.*

If the temperature of the windings of a transformer with a ferrite core, measured as specified in 1.4.12, exceeds 180 °C, it shall be retested at maximum rated ambient temperature ($T_{amb} = T_{ma}$), and not as calculated according to 1.4.12.

NOTE The above procedure is to ensure that deteriorating Curie characteristics of ferrite at temperatures approaching 200 °C do not cause thermal runaway (unpredictable temperature rise).

Secondary windings that exceed the temperature limits but that become open circuit or otherwise require replacement of the transformer do not constitute a failure of this test, provided that no hazard is created in the meaning of this standard.

For compliance criteria see 5.3.9.

Table C.1 – Temperature limits for transformer windings

| Method of protection | Thermal class | | | | | | | |
|---|---------------|---------|---------|---------|---------|-----|-----|-----|
| | 105 (A) | 120 (E) | 130 (B) | 155 (F) | 180 (H) | 200 | 220 | 250 |
| Protection by inherent or external impedance | 150 | 165 | 175 | 200 | 225 | 245 | 265 | 295 |
| Protection by protective device that operates during the first hour | 200 | 215 | 225 | 250 | 275 | 295 | 315 | 345 |
| Protection by any protective device: | | | | | | | | |
| – maximum after first hour | 175 | 190 | 200 | 225 | 250 | 270 | 290 | 320 |
| – arithmetic average during the 2nd hour and during the 72nd hour | 150 | 165 | 175 | 200 | 225 | 245 | 265 | 295 |

Maximum temperature °C

The designations A to H, formerly assigned in IEC 60085 to thermal classes 105 to 180, are given in parentheses.

The arithmetic average temperature is determined as follows:

The graph of temperature against time (see Figure C.1), while the power to the transformer is cycling on and off, is plotted for the period of test under consideration. The arithmetic average temperature (t_A) is determined by the formula:

$$t_A = \frac{t_{max} + t_{min}}{2}$$

where

t_{max} is the average of the maxima;

t_{min} is the average of the minima.

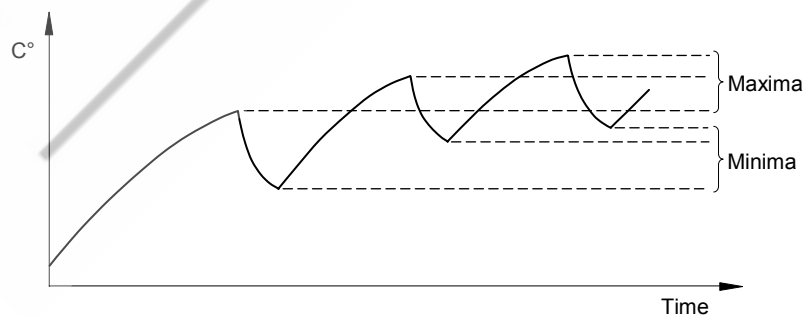

IEC 1563/05

Figure C.1 – Determination of arithmetic average temperature

C.2 Insulation

Insulation in transformers shall comply with the following requirements.

Windings and conductive parts of transformers shall be treated as parts of the circuits to which they are connected, if any. The insulation between them shall comply with the relevant requirements of 2.10 (or Annex G) and pass the relevant tests of 5.2, according to the application of the insulation in the equipment (see 2.9.3).

Precautions shall be taken to prevent the reduction below the specified minimum values of CLEARANCES and CREEPAGE DISTANCE that provide BASIC INSULATION, SUPPLEMENTARY INSULATION or REINFORCED INSULATION by:

- displacement of windings or their turns;
- displacement of internal wiring or wires for external connections;
- undue displacement of parts of windings or internal wiring, in the event of rupture of wires adjacent to connections or loosening of the connections;
- bridging of insulation by wires, screws, washers and the like should they loosen or become free.

It is not expected that two independent fixings will loosen at the same time.

All windings shall have the end turns retained by positive means.

Compliance is checked by inspection, measurement and, if necessary, by the following tests.

If the transformer is fitted with a screen for protective earthing purposes that is separated from the primary winding connected to a HAZARDOUS VOLTAGE circuit by BASIC INSULATION only, the screen shall comply with one of the following:

- *meet the requirements of 2.6.3.3;*
- *meet the requirements of 2.6.3.4 between the earthed screen and the main protective earthing terminal of the equipment;*
- *pass a test simulating breakdown of BASIC INSULATION between the screen and the associated primary winding. The transformer shall be protected by any protective device used in the end application. The protective earthing path and the screen shall not be damaged.*

If tests are conducted, a specially prepared sample transformer having an extra lead-out wire from the free end of the screen is used to ensure that the current during the test passes through the screen.

Examples of acceptable forms of construction (see 1.3.8) are the following:

- *windings isolated from each other by placing them on separate limbs of the core, with or without spools;*
- *windings on a single spool with a partition wall, where either the spool and partition wall are pressed or moulded in one piece, or a pushed-on partition wall has an intermediate sheath or covering over the joint between the spool and the partition wall;*

- *concentric windings on a spool of insulating material without flanges, or on insulation applied in thin sheet form to the transformer core;*
- *insulation is provided between windings consisting of sheet insulation extending beyond the end turns of each layer;*
- *concentric windings, separated by an earthed conductive screen that consists of metal foil extending the full width of the windings, with suitable insulation between each winding and the screen. The conductive screen and its lead-out wire have a cross section sufficient to ensure that on breakdown of the insulation an overload device will open the circuit before the screen is destroyed. The overload device may be a part of the transformer.*



Annex D
(normative)

Measuring instruments for touch current tests

(see 5.1.4)

D.1 Measuring instrument

The measuring instrument of Figure D.1 is from Figure 4 of IEC 60990.

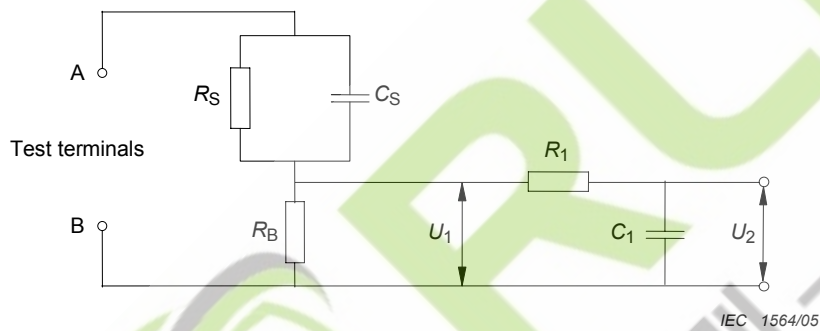

| | | |
|---|---------------------|--|
| R_S | 1 500 Ω | |
| R_B | 500 Ω | |
| R_1 | 10 k Ω | |
| C_S | 0,22 μF | |
| C_1 | 0,022 μF | |
| Voltmeter or oscilloscope (r.m.s. or peak reading) | Input resistance: | >1 M Ω |
| | Input capacitance: | <200 pF |
| | Frequency range: | 15 Hz up to 1 MHz (appropriate for the highest frequency of interest, see 1.4.7) |

Figure D.1 – Measuring instrument

The measuring instrument is calibrated by comparing the frequency factor of U_2 with the solid line in Figure F.2 of IEC 60990 at various frequencies. A calibration curve is constructed showing the deviation of U_2 from the ideal curve as a function of frequency.

D.2 Alternative measuring instrument

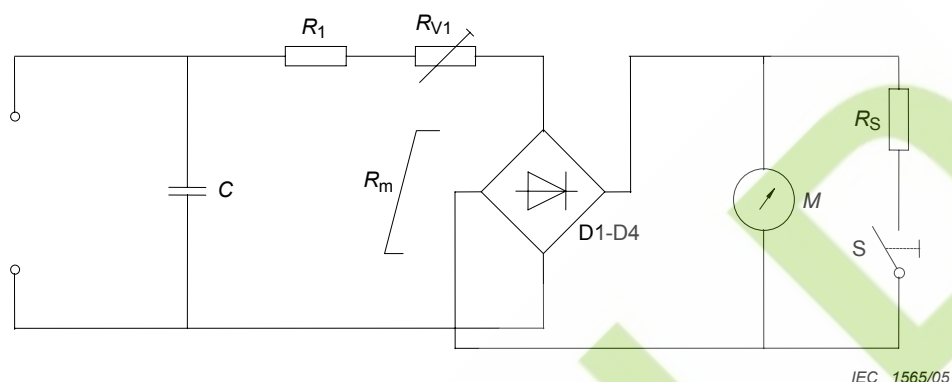

| | |
|---------------------------------------|---|
| M | 0 mA – 1 mA moving coil movement |
| $R_1 + R_{V1} + R_m$ at 0,5 mA d.c. = | 1 500 $\Omega \pm 1\%$ with $C = 150 \text{ nF} \pm 1\%$ or 2 000 $\Omega \pm 1\%$ with $C = 112 \text{ nF} \pm 1\%$ |
| D1-D4 | Rectifier |
| R_s | Non-inductive shunt for $\times 10$ range |
| S | Sensitivity button (press for maximum sensitivity) |

Figure D.2 – Alternative measuring instrument

The instrument comprises a rectifier/moving coil meter with additional series resistance, the two being shunted by a capacitor, as shown in Figure D.2. The effect of the capacitor is to reduce the sensitivity to harmonics and other frequencies above the power frequency. The instrument should also include a $\times 10$ range obtained by shunting the meter coil by a non-inductive resistor. It is also permitted to include overcurrent protection, provided that the method used does not affect the basic characteristics of the instrument.

R_{V1} is adjusted for the desired value of total resistance at 0,5 mA d.c.

The meter is calibrated at the following calibration points on the maximum sensitivity range at 50 Hz to 60 Hz sinusoidal:

0,25 mA, 0,5 mA, 0,75 mA.

The following response is checked at the 0,5 mA calibration point:

Sensitivity at 5 kHz sinusoidal: 3,6 mA $\pm 5\%$.

Annex E (normative)

Temperature rise of a winding

(see 1.4.13)

The value of the temperature rise of a winding is calculated from the formula:

for a copper winding
$$\Delta t = \frac{R_2 - R_1}{R_1} (234,5 + t_1) - (t_2 - t_1)$$

for an aluminium winding
$$\Delta t = \frac{R_2 - R_1}{R_1} (225 + t_1) - (t_2 - t_1)$$

where

Δt is the temperature rise, in kelvins;

R_1 is the resistance of the winding at the beginning of the test, in ohms;

R_2 is the resistance of the winding at the end of the test, in ohms;

t_1 is the room temperature at the beginning of the test, in degrees Celsius;

t_2 is the room temperature at the end of the test, in degrees Celsius.

At the beginning of the test, the windings are at room temperature.

It is recommended that the resistance of windings at the end of the test be determined by taking resistance measurements as soon as possible after switching off, and then at short intervals so that a curve of resistance against time can be plotted for ascertaining the resistance at the instant of switching off.

For comparison of winding temperatures determined by the resistance method of this annex with the temperature limits of Table 4B, 25 °C shall be added to the calculated temperature rise.

Annex F
(normative)**Measurement of clearances and creepage distances**

(see 2.10 and Annex G)

The methods of measuring CLEARANCES and CREEPAGE DISTANCES that are specified in the following figures are used in interpreting the requirements of this standard.

In the following figures, the value of X is given in Table F.1. Where the distance shown is less than X , the depth of the gap or groove is disregarded when measuring a CREEPAGE DISTANCE.

Table F.1 is valid only if the specified minimum CLEARANCE is 3 mm or more. If the specified minimum CLEARANCE is less than 3 mm, the value of X is the lesser of:

- the relevant value in Table F.1; or
- one third of the specified minimum CLEARANCE.

Table F.1 – Value of X

| Pollution degree (see 2.10.1.2) | X mm |
|------------------------------------|-----------|
| 1 | 0,25 |
| 2 | 1,0 |
| 3 | 1,5 |

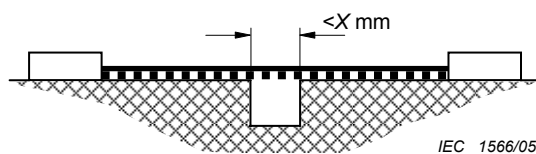

Condition: Path under consideration includes a parallel or converging-sided groove of any depth with width less than X mm.

Rule: CLEARANCE and CREEPAGE DISTANCE are measured directly across the groove.

Figure F.1 – Narrow groove

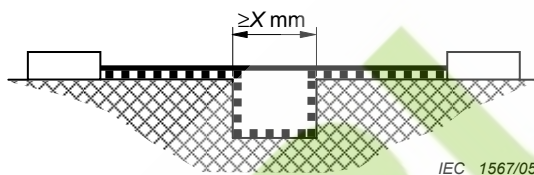

Condition: Path under consideration includes a parallel-sided groove of any depth, and equal to or more than X mm wide.

Rule: CLEARANCE is the "line of sight" distance. CREEPAGE DISTANCE path follows the contour of the groove.

Figure F.2 – Wide groove

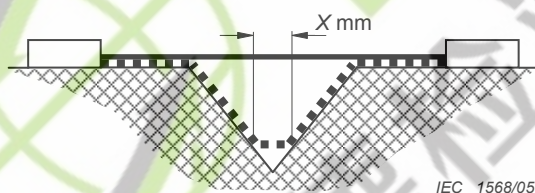

Condition: Path under consideration includes a V-shaped groove with internal angle of less than 80° and a width greater than X mm.

Rule: CLEARANCE is "line of sight" distance. CREEPAGE DISTANCE path follows the contour of the groove but "short-circuits" the bottom of the groove by a link X mm long.

Figure F.3 – V-shaped groove

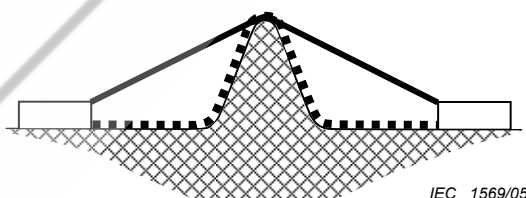

Condition: Path under consideration includes a rib.

Rule: CLEARANCE is the shortest direct air path over the top of the rib. CREEPAGE DISTANCE path follows the contour of the rib.

Figure F.4 – Rib

———— CLEARANCE ■■■■■ CREEPAGE DISTANCE

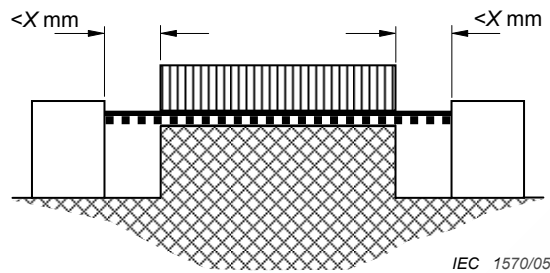

Condition: Path under consideration includes an uncemented joint with grooves less than X mm wide on either side.

Rule: CLEARANCE and CREEPAGE DISTANCE path is the "line of sight" distance shown.

Figure F.5 – Uncemented joint with narrow groove

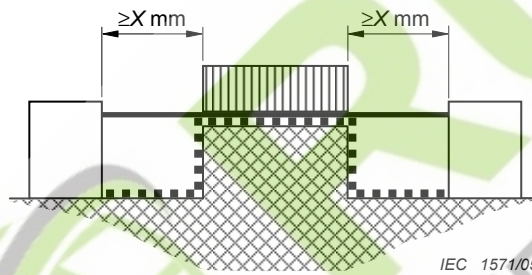

Condition: Path under consideration includes an uncemented joint with a groove equal to or more than X mm wide each side.

Rule: CLEARANCE is the "line of sight" distance. CREEPAGE DISTANCE path follows the contour of the groove.

Figure F.6 – Uncemented joint with wide groove

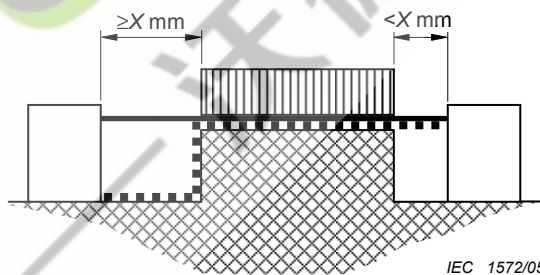

Condition: Path under consideration includes an uncemented joint with a groove on one side less than X mm wide and a groove on the other equal to or more than X mm wide.

Rule: CLEARANCE and CREEPAGE DISTANCE path are as shown.

Figure F.7 – Uncemented joint with narrow and wide grooves

———— CLEARANCE ■■■■■ CREEPAGE DISTANCE

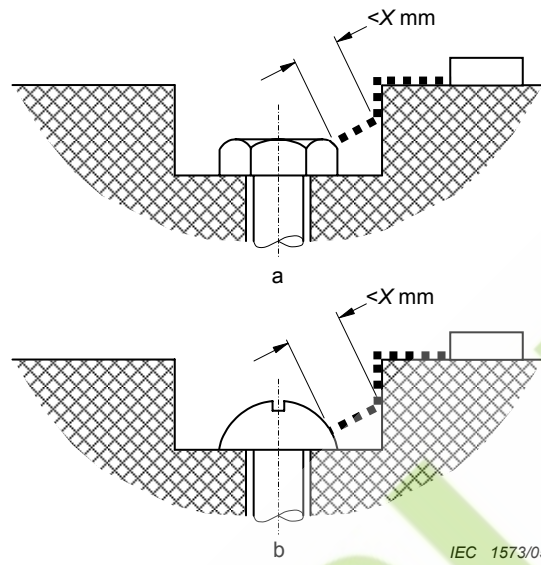

Gap between head of screw and wall of recess too narrow to be taken into account.

Figure F.8 – Narrow recess

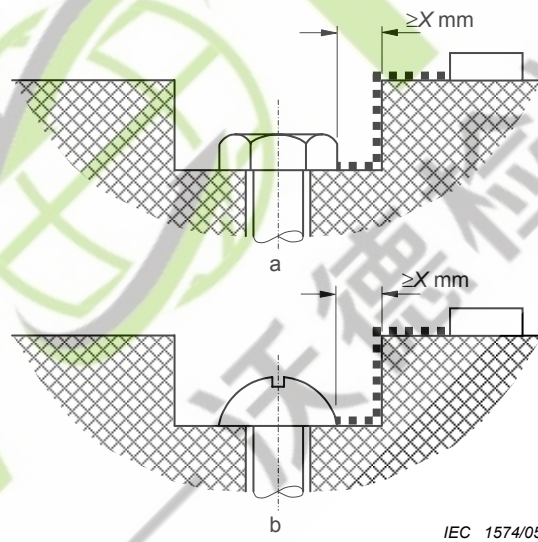

Gap between head of screw and wall of recess wide enough to be taken into account.

Figure F.9 – Wide recess

■■■■■■■■ CREEPAGE DISTANCE

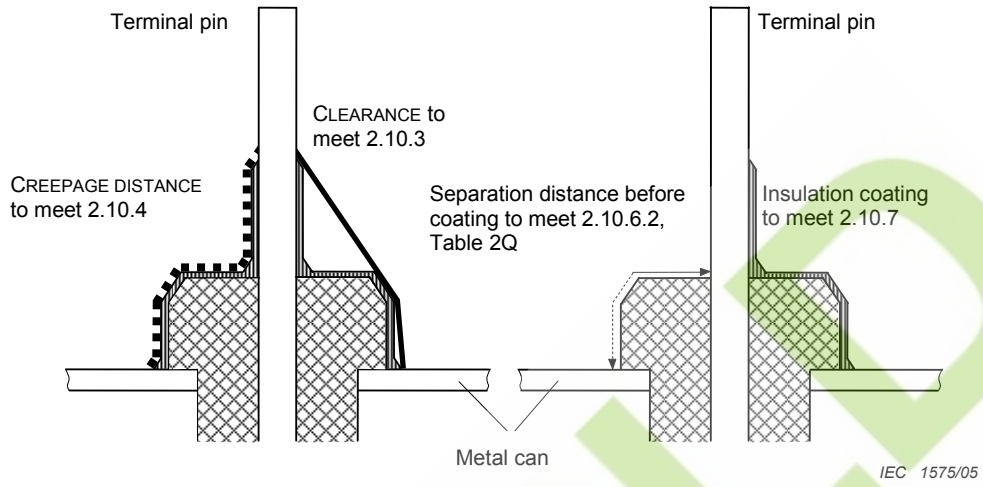

Figure F.10 – Coating around terminals

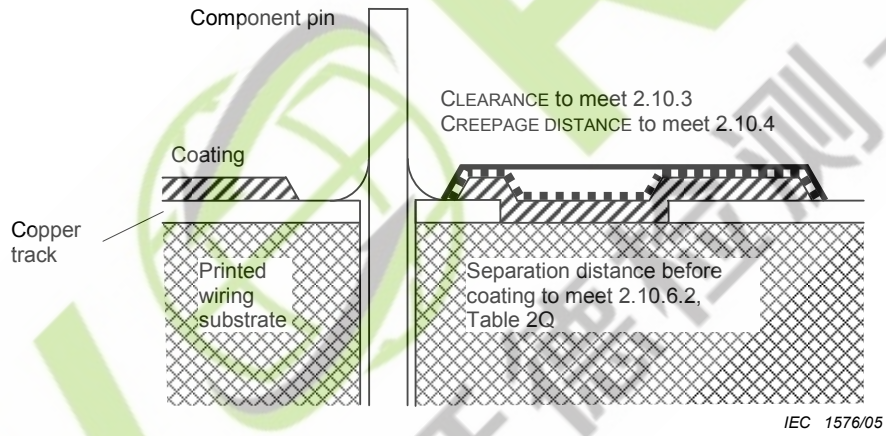
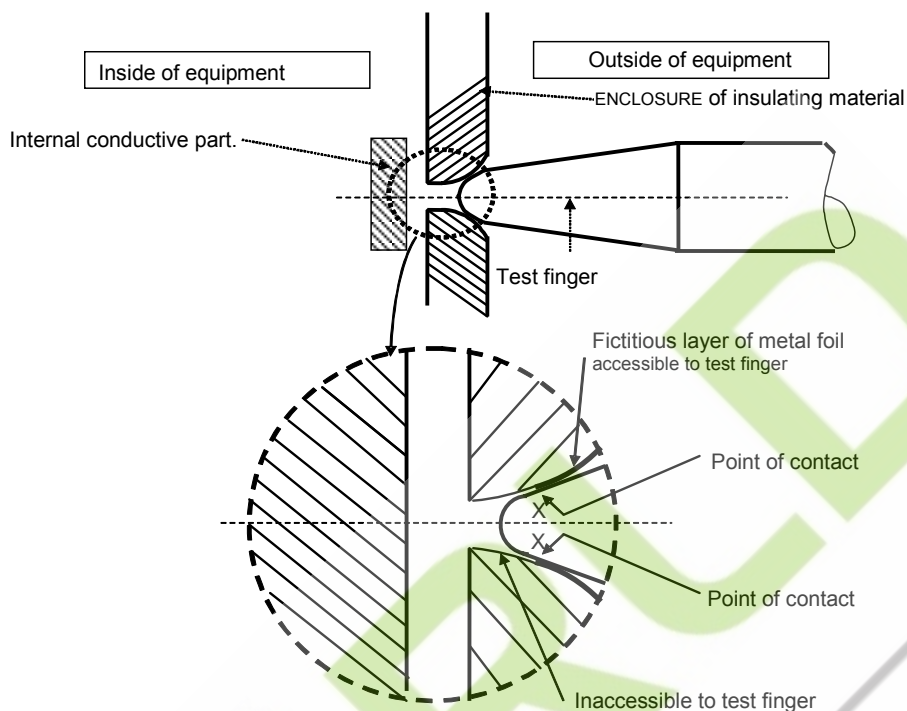

Figure F.11 – Coating over printed wiring

— CLEARANCE ■■■■■ CREEPAGE DISTANCE



Point X is used for measurements of CLEARANCES and CREEPAGE DISTANCES from the BOUNDING SURFACE of an ENCLOSURE of insulating material to an internal conductive part (see 2.10.3.1 and 2.10.4)

IEC 1577/05

Figure F.12 – Measurements through openings in enclosures

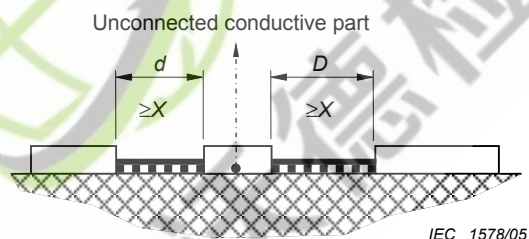

Condition: Insulation distance with intervening, unconnected conductive part.

Rule: CLEARANCE is the distance $d + D$.

CREEPAGE DISTANCE is also $d + D$.

Where the value of d or D is smaller than X , it shall be considered as zero.

Figure F.13 – Intervening, unconnected conductive part

———— CLEARANCE ■■■■■ CREEPAGE DISTANCE

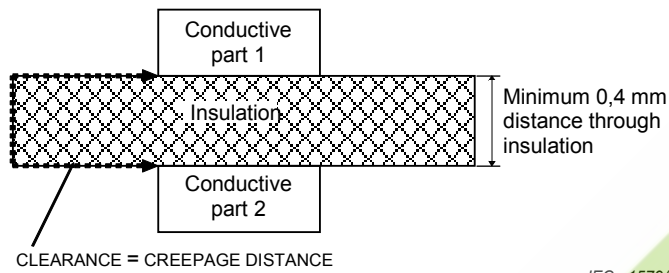

Thick sheet or solid insulating material as SUPPLEMENTARY INSULATION or REINFORCED INSULATION

Figure F.14 – Solid insulating material

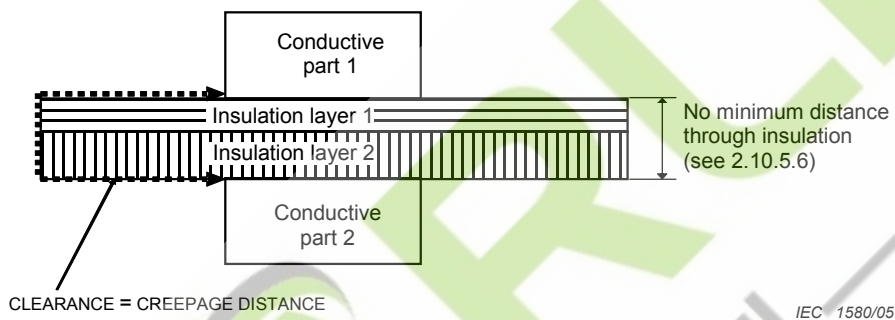

Two layers of thin sheet material as SUPPLEMENTARY INSULATION or REINFORCED INSULATION

Figure F.15 – Thin sheet insulating material

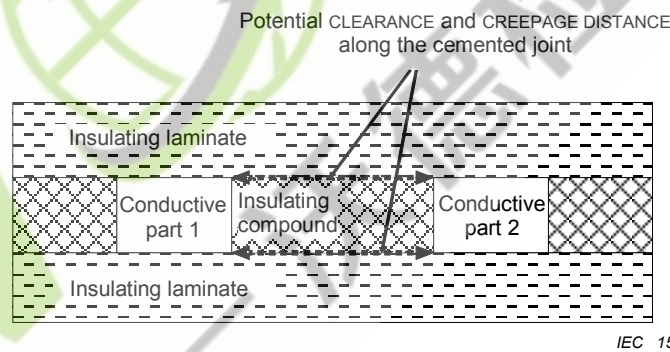

Insulating compound as SUPPLEMENTARY INSULATION or REINFORCED INSULATION

Figure F.16 – Cemented joints in multi-layer printed board

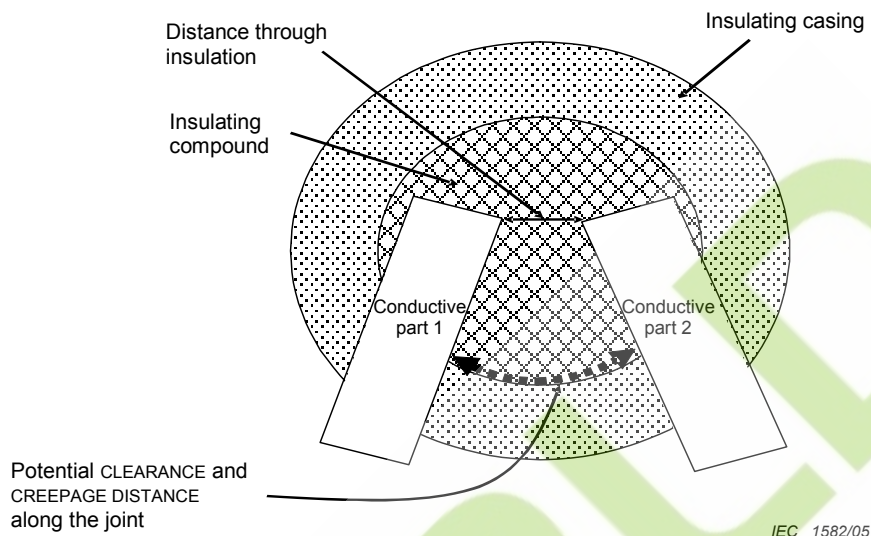

Insulating compound as SUPPLEMENTARY INSULATION or REINFORCED INSULATION inside a component

Figure F.17 – Component filled with insulating compound

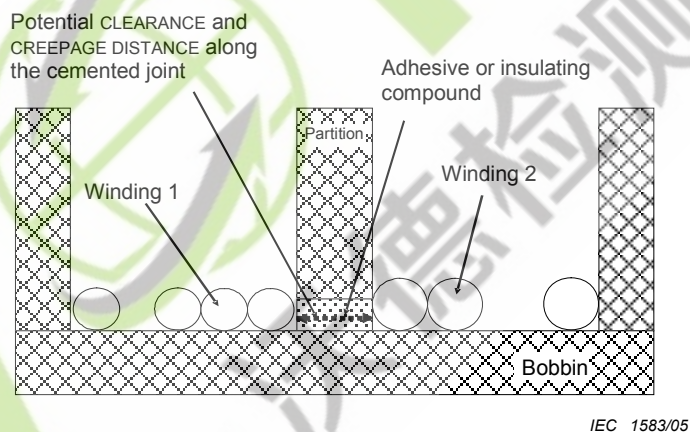

Cemented joint as SUPPLEMENTARY INSULATION or REINFORCED INSULATION

Figure F.18 – Partitioned bobbin

Annex G (normative)

Alternative method for determining minimum clearances

G.1 Clearances

G.1.1 General

CLEARANCES shall be so dimensioned that overvoltages, including transients, which may enter the equipment, and peak voltages that may be generated within the equipment, do not break down the CLEARANCE.

It is permitted to use either the requirements of 2.10.3 for Overvoltage Category I or Overvoltage Category II, using the PEAK WORKING VOLTAGE, or the requirements in Annex G for Overvoltage Category I, Overvoltage Category II, Overvoltage Category III or Overvoltage Category IV, using the REQUIRED WITHSTAND VOLTAGE, for a particular component or subassembly or for the whole equipment.

NOTE It is considered to be good practice to design SOLID INSULATION for higher transient overvoltages than the associated CLEARANCE.

G.1.2 Summary of the procedure for determining minimum clearances

NOTE 1 The minimum CLEARANCES for FUNCTIONAL INSULATION, BASIC INSULATION, SUPPLEMENTARY INSULATION and REINFORCED INSULATION, whether in a PRIMARY CIRCUIT or another circuit, depend on the REQUIRED WITHSTAND VOLTAGE. The REQUIRED WITHSTAND VOLTAGE depends in turn on the combined effect of the normal operating voltage (including repetitive peaks due to internal circuitry such as switch mode power supplies) and non-repetitive overvoltages due to external transients.

To determine the minimum value for each CLEARANCE, the following steps shall be used.

- (1) Measure the PEAK WORKING VOLTAGE across the CLEARANCE in question.
- (2) If the equipment is mains operated:
 - determine the MAINS TRANSIENT VOLTAGE (Clause G.2); and
 - for equipment to be connected to an AC MAINS SUPPLY, calculate the peak value of the nominal AC MAINS SUPPLY voltage.
- (3) Use the rules in G.4.1 and the above voltage values to determine the required withstand voltage for mains transients and internal repetitive peaks. In the absence of transients coming from a telecommunication network, go to step 7.
- (4) If the equipment is to be connected to a telecommunication network, determine the telecommunication network transient voltage (Clause G.3).
- (5) Use the telecommunication network transient voltage and the rules in G.4.2 to determine the required withstand voltage for telecommunication network transients. In the absence of mains and internal repetitive peaks, go to step 7.
- (6) Use the rule in G.4.3 to determine the total required withstand voltage.
- (7) Use the REQUIRED WITHSTAND VOLTAGE to determine the minimum CLEARANCE (Clause G.6).

NOTE 2 The effect of transients from a CABLE DISTRIBUTION SYSTEM is not taken into account (see G.4.4 and 7.4.1).

G.2 Determination of mains transient voltage

G.2.1 AC mains supply

For equipment to be supplied from the AC MAINS SUPPLY, the value of the MAINS TRANSIENT VOLTAGE depends on the overvoltage category and the AC MAINS SUPPLY voltage. In general, CLEARANCES in equipment intended to be connected to the AC MAINS SUPPLY shall be designed for Overvoltage Category II.

NOTE 1 See Annex Z for further guidance on the determination of overvoltage category.

Equipment that is likely, when installed, to be subjected to transient overvoltages that exceed those for its design Overvoltage Category II, will require additional protection to be provided external to the equipment. In this case, the installation instructions shall state the need for such external protection.

The applicable value of the MAINS TRANSIENT VOLTAGE shall be determined from the overvoltage category and the AC MAINS SUPPLY voltage, using Table G.1.

Table G.1 – AC mains transient voltages

| AC MAINS SUPPLY voltage ^a V r.m.s. | MAINS TRANSIENT VOLTAGE ^b V peak | | | |
|--|--|-------|-------|-------|
| | Overvoltage Category | | | |
| | I | II | III | IV |
| up to and including 50 | 330 | 500 | 800 | 1 500 |
| over 50 up to and including 100 | 500 | 800 | 1 500 | 2 500 |
| over 100 up to and including 150 ^c | 800 | 1 500 | 2 500 | 4 000 |
| over 150 up to and including 300 ^d | 1 500 | 2 500 | 4 000 | 6 000 |
| over 300 up to and including 600 ^e | 2 500 | 4 000 | 6 000 | 8 000 |

^a For equipment designed to be connected to a three-phase, three-wire supply, where there is no neutral conductor, the AC MAINS SUPPLY voltage is the line-to-line voltage. In all other cases, where there is a neutral conductor, it is the line-to-neutral voltage.

^b The MAINS TRANSIENT VOLTAGE is always one of the values in the table. Interpolation is not permitted.

^c Including 120/208 V and 120/240 V.

^d Including 230/400 V and 277/480 V.

^e Including 400/690 V.

Ⓒ Note deleted Ⓒ

G.2.2 Earthed d.c. mains supplies

If a DC MAINS SUPPLY is connected to protective earth and is entirely within a single building, the MAINS TRANSIENT VOLTAGE shall be assumed to be 71 V peak. If this connection is within the EUT, it shall be in accordance with 2.6.1 e).

NOTE The connection to protective earth can be at the source of the DC MAINS SUPPLY or at the equipment location, or both (see ITU-T Recommendation K.27).

G.2.3 Unearthed d.c. mains supplies

If a DC MAINS SUPPLY is not earthed and located as in G.2.2, the MAINS TRANSIENT VOLTAGE shall be assumed to be equal to the MAINS TRANSIENT VOLTAGE in the AC MAINS SUPPLY from which the DC MAINS SUPPLY is derived.

G.2.4 Battery operation

If equipment is supplied from a dedicated battery that has no provision for charging from an external MAINS SUPPLY, the MAINS TRANSIENT VOLTAGE shall be assumed to be 71 V peak.

G.3 Determination of telecommunication network transient voltage

If the TELECOMMUNICATION NETWORK TRANSIENT VOLTAGE is known for the TELECOMMUNICATION NETWORK in question, it is permitted to use the known value in G.4.2.

If the TELECOMMUNICATION NETWORK TRANSIENT VOLTAGE is not known, one of the following values shall be used:

- 1 500 V peak if the circuit connected to the TELECOMMUNICATION NETWORK is a TNV-1 CIRCUIT or a TNV-3 CIRCUIT; or
- 800 V peak if the circuit connected to the TELECOMMUNICATION NETWORK is an SELV CIRCUIT or a TNV-2 CIRCUIT.

The effect of a telephone ringing signal is not taken into account for this purpose.

G.4 Determination of required withstand voltage

G.4.1 Mains transients and internal repetitive peaks

In G.4.1, the effect of transients coming from a TELECOMMUNICATION NETWORK is ignored (see G.4.3).

The REQUIRED WITHSTAND VOLTAGE is determined according to Items a), b) or c).

NOTE Items a) and b) apply only for an AC MAINS SUPPLY. Item c) applies only for a DC MAINS SUPPLY.

The following abbreviations are used.

| | |
|-------------------------------|--|
| U_{pw} | the PEAK WORKING VOLTAGE of the CLEARANCE |
| $U_{a.c. \text{ mains peak}}$ | peak value of the AC MAINS SUPPLY voltage in the first column of Table G.1 corresponding to the RATED VOLTAGE or the upper limit of the RATED VOLTAGE RANGE. |
| $U_{\text{mains transient}}$ | the MAINS TRANSIENT VOLTAGE determined in G.2.1 or G.2.2 |
| U_{measured} | the maximum transient voltage from the mains, determined according to G.5 a) |

a) PRIMARY CIRCUITS

It is permitted to use a1) or a2).

a1) The following Rules 1) and 2) shall be applied:

Rule 1) If $U_{pw} \leq U_{a.c. \text{ mains peak}}$

$$U_{\text{required withstand}} = U_{\text{mains transient}}.$$

Rule 2) If $U_{pw} > U_{a.c. \text{ mains peak}}$

$$U_{\text{required withstand}} = U_{\text{mains transient}} + U_{pw} - U_{a.c. \text{ mains peak}}.$$

a2) The above Rules 1) and 2) shall be applied, but $U_{\text{mains transient}}$ shall be replaced by U_{measured} .

b) SECONDARY CIRCUITS whose PRIMARY CIRCUIT is supplied from an AC MAINS SUPPLY

It is permitted to use b1), b2) or b3).

b1) The following Rule 3) shall be applied:

Rule 3) $U_{\text{required withstand}} = U_{\text{mains transient}}$ or U_{pw} , whichever is the greater.

b2) The above Rule 3) shall be applied, but with $U_{\text{mains transient}}$ replaced by U_{measured} .

b3) The above Rule 3) shall be applied, but with $U_{\text{mains transient}}$ replaced by a voltage that is one step smaller in the following list from Table G.1:

330, 500, 800, 1 500, 2 500, 4 000, 6 000 and 8 000 V peak.

This is permitted in the following cases:

- a SECONDARY CIRCUIT, derived from an AC MAINS SUPPLY, that is connected to the main protective earthing terminal in accordance with 2.6.1 e);
- a SECONDARY CIRCUIT, derived from an AC MAINS SUPPLY and separated from the PRIMARY CIRCUIT by a metal screen that is connected to the main protective earthing terminal in accordance with 2.6.1 e).

c) SECONDARY CIRCUIT supplied from a DC MAINS SUPPLY

The above b1) or b3) shall be applied.

G.4.2 Transients from telecommunication networks

In G.4.2, the effect of transients coming from the mains and from internal circuitry is ignored (see G.4.3).

For transients from a TELECOMMUNICATION NETWORK, the REQUIRED WITHSTAND VOLTAGE is:

- the TELECOMMUNICATION NETWORK TRANSIENT VOLTAGE determined in Clause G.3;
- or the value measured in accordance with G.5 b);

whichever is less.

G.4.3 Combination of transients

If the transients described in G.4.1 and those described in G.4.2 affect the same CLEARANCE, the REQUIRED WITHSTAND VOLTAGE is the larger of the two voltages. The two values shall not be added together.

G.4.4 Transients from cable distribution systems

The effect of transients from a CABLE DISTRIBUTION SYSTEM is not taken into account when determining REQUIRED WITHSTAND VOLTAGE (however, see 7.4.1).

G.5 Measurement of transient voltages

The following tests are conducted only if it is required to determine whether or not the maximum transient voltage across the CLEARANCE in any circuit is lower than the MAINS TRANSIENT VOLTAGE determined in Clause G.2 (for example, due to the effect of a filter in the equipment). If these tests are not conducted, the maximum transient voltage across the CLEARANCE shall be assumed to be equal to the MAINS TRANSIENT VOLTAGE. If the situation covered by G.2.2 or the situation covered by G.2.4 applies, the transient voltage across the CLEARANCE shall be assumed to be negligible and no test is conducted.

If necessary, the transient voltage across the CLEARANCE is measured using the following test procedure.

During the tests, the EUT is connected to its separate power supply unit, if any, but is not connected to the MAINS SUPPLY, nor to any TELECOMMUNICATION NETWORKS, and any surge suppressors in PRIMARY CIRCUITS are disconnected.

A voltage measuring device is connected across the CLEARANCE in question.

a) Transients from a MAINS SUPPLY

To measure the transient voltages across a CLEARANCE due to transients on a MAINS SUPPLY, the impulse test generator reference 2 of Table N.1 is used to generate 1,2/50 μ s impulses. U_c is equal to the MAINS TRANSIENT VOLTAGE determined in Clause G.2.

Three to six impulses of alternating polarity, with intervals of at least 1 s between impulses, are applied between each of the following points where relevant:

For an AC MAINS SUPPLY:

- line-to-line;
- all line conductors conductively joined together and neutral;
- all line conductors conductively joined together and the main protective earthing terminal;
- neutral and the main protective earthing terminal.

For a DC MAINS SUPPLY:

- the positive and negative supply connection points;
- all supply connection points conductively joined together and the main protective earthing terminal.

b) Transients from a TELECOMMUNICATION NETWORK

To measure the transient voltage across a CLEARANCE due to transients on a TELECOMMUNICATION NETWORK, the impulse test generator reference 1 of Table N.1 is used to generate 10/700 μ s impulses. U_c is equal to the TELECOMMUNICATION NETWORK TRANSIENT VOLTAGE determined in Clause G.3.

Three to six impulses of alternating polarity, with intervals of at least 1 s between impulses, are applied between each of the following TELECOMMUNICATION NETWORK connection points of each interface type:

- each pair of terminals (for example, A and B or tip and ring) in an interface;
- all terminals of a single interface joined together and earth.

Where there are several identical circuits, only one is tested.

G.6 Determination of minimum clearances

For equipment to be operated up to 2 000 m above sea level, each CLEARANCE shall comply with the minimum dimensions given in Table G.2, using the value of REQUIRED WITHSTAND VOLTAGE determined according to G.4.

For equipment to be operated at more than 2 000 m above sea level, the minimum CLEARANCES shall be multiplied by the factor given in Table A.2 of. Linear interpolation is permitted between the nearest two points in Table A.2 of IEC 60664-1. The calculated minimum CLEARANCE using this multiplication factor shall be rounded up to the next higher 0,1 mm increment.

The specified minimum CLEARANCES are subject to the following minimum values:

- 10 mm for an air gap serving as REINFORCED INSULATION between a part at HAZARDOUS VOLTAGE and an accessible conductive part of the ENCLOSURE of floor-standing equipment or of the non-vertical top surface of desk-top equipment;
- 2 mm for an air gap serving as BASIC INSULATION between a part at HAZARDOUS VOLTAGE and an earthed accessible conductive part of the ENCLOSURE of PLUGGABLE EQUIPMENT TYPE A.

The above two dashed paragraphs do not apply between a part at a HAZARDOUS VOLTAGE and a BOUNDING SURFACE.

Except as required by 2.8.7.1 the specified minimum CLEARANCES do not apply to the air gap between the contacts of THERMOSTATS, THERMAL CUT-OUTS, overload protection devices, switches of microgap construction and similar components where the air gap varies with the contacts.

NOTE 1 For air gaps between contacts of disconnect devices, see 3.4.2. For air gaps between the contacts of interlock switches, see 2.8.7.1.

The CLEARANCES between the BOUNDING SURFACE of a connector and conductive parts within the connector that are connected to a HAZARDOUS VOLTAGE shall comply with the requirements for REINFORCED INSULATION. As an exception, for connectors that are

- fixed to the equipment; and
- located internal to the outer ENCLOSURE of the equipment; and
- only accessible after removal of a USER-replaceable subassembly that is required to be in place during normal operation,

these CLEARANCES shall comply with the requirements for BASIC INSULATION.

NOTE 2 The tests of 2.1.1.1 for access to hazardous parts apply to such connectors after removal of the subassembly.

For all other CLEARANCES in connectors, including connectors that are not fixed to the equipment, the minimum values specified in Table G.2 apply.

The above minimum CLEARANCES for connectors do not apply to connectors that comply with a standard harmonized with IEC 60083, IEC 60309, IEC 60320, IEC 60906-1 or IEC 60906-2, see also 1.5.2.

Table G.2 – Minimum clearances up to 2 000 m above sea level

| CLEARANCES in mm | | | | | | | | | |
|---|------------------------------------|-----|-----|---|-----|-----|-----------------------|-----|-----|
| REQUIRED WITHSTAND VOLTAGE | FUNCTIONAL INSULATION ^a | | | BASIC INSULATION and SUPPLEMENTARY INSULATION | | | REINFORCED INSULATION | | |
| | Pollution degree | | | | | | | | |
| V peak or d.c. up to and including | 1 ^b | 2 | 3 | 1 ^b | 2 | 3 | 1 ^b | 2 | 3 |
| 400 | 0,1 | 0,2 | 0,8 | 0,2 (0,1) | 0,2 | 0,8 | 0,4 (0,2) | 0,4 | 1,6 |
| 800 | 0,1 | 0,2 | 0,8 | 0,2 (0,1) | 0,2 | 0,8 | 0,4 (0,2) | 0,4 | 1,6 |
| 1 000 | 0,2 | 0,2 | 0,8 | 0,3 (0,2) | | 0,8 | 0,6 (0,4) | | 1,6 |
| 1 200 | 0,3 | | 0,8 | 0,4 (0,3) | | 0,8 | 0,8 (0,6) | | 1,6 |
| 1 500 | 0,5 | | 0,8 | 0,8 (0,5) | | 0,8 | 1,6 (1,0) | | 1,6 |
| 2 000 | 1,0 | | | 1,3 (1,0) | | | 2,6 (2,0) | | |
| 2 500 | 1,5 | | | 2,0 (1,5) | | | 4,0 (3,0) | | |
| 3 000 | 2,0 | | | 2,6 (2,0) | | | 5,2 (4,0) | | |
| 4 000 | 3,0 | | | 4,0 (3,0) | | | 6,0 | | |
| 6 000 | 5,5 | | | 7,5 (5,5) | | | 11 | | |
| 8 000 | 8,0 | | | 11 (8,0) | | | 16 | | |
| 10 000 | 11 | | | 15 (11) | | | 22 | | |
| 12 000 | 14 | | | 19 (14) | | | 28 | | |
| 15 000 | 18 | | | 24 (18) | | | 36 | | |
| 25 000 | 33 | | | 44 (33) | | | 66 | | |
| 40 000 | 60 | | | 80 (60) | | | 120 | | |
| 50 000 | 75 | | | 100 (75) | | | 150 | | |
| 60 000 | 90 | | | 120 (90) | | | 180 | | |
| 80 000 | 130 | | | 173 (130) | | | 260 | | |
| 100 000 | 170 | | | 227 (170) | | | 340 | | |
| <p>Linear interpolation is permitted between the nearest two points, the calculated minimum CLEARANCES being rounded up to the next higher 0,1 mm increment.</p> <p>The values in parentheses apply only if manufacturing is subjected to a quality control programme that provides at least the same level of assurance as the example given in Clause R.2. DOUBLE INSULATION and REINFORCED INSULATION shall be subjected to ROUTINE TESTS for electric strength.</p> <p>In a SECONDARY CIRCUIT, a minimum CLEARANCE of 5 mm replaces any higher value, provided that the insulation involved passes an electric strength test according to 5.2.2 using:</p> <ul style="list-style-type: none"> - an a.c. test voltage whose r.m.s. value is 106 % of the PEAK WORKING VOLTAGE (peak value 150 % of the PEAK WORKING VOLTAGE), or - a d.c. test voltage equal to 150 % of the PEAK WORKING VOLTAGE. <p>If the CLEARANCE path is partly along the surface of insulation that is not Material Group I, the test voltage is applied across the air gap and the Material Group I only. The part of the path along the surface of any other insulating material is bypassed.</p> | | | | | | | | | |
| <p>^a There is no minimum CLEARANCE for FUNCTIONAL INSULATION unless it is required by 5.3.4 a).</p> <p>^b It is permitted to use the values for Pollution Degree 1 if one sample passes the tests of 2.10.10.</p> | | | | | | | | | |

Compliance is checked by measurement, taking into account Annex F. The following conditions apply

- movable parts shall be placed in the most unfavourable position;
- for equipment incorporating ordinary NON-DETACHABLE POWER SUPPLY CORDS, CLEARANCE measurements are made with supply conductors of the largest cross-sectional area specified in 3.3.4, and also without conductors;

NOTE 3 The force tests of 4.2.2, 4.2.3 and 4.2.4 apply.

- when measuring CLEARANCES from the BOUNDING SURFACE of an ENCLOSURE of insulating material through a slot or opening in the ENCLOSURE, or through an opening in an accessible connector, the accessible surface shall be considered to be conductive as if it were covered by metal foil wherever it can be touched by the test finger, Figure 2A (see 2.1.1.1), applied without appreciable force (see Figure F.12, point X).

There is no need to conduct an electric strength test to verify CLEARANCES except as required in Table G.2 if a minimum 5 mm CLEARANCE is used.

Annex H
(normative)**Ionizing radiation**

(see 4.3.13)

Equipment that might produce ionizing radiation is checked by measuring the amount of radiation.

The amount of radiation is determined by means of a radiation monitor of the ionizing chamber type with an effective area of 1 000 mm² or by measuring equipment of other types giving equivalent results.

Measurements are made with the equipment on test operating at the most unfavourable supply voltage (see 1.4.5) and with OPERATOR controls and service controls adjusted so as to give maximum radiation whilst maintaining the equipment operative for normal use.

Internal preset controls not intended to be adjusted during the lifetime of the equipment are not considered to be service controls.

Ⓒ *At any point 10 cm from the surface of the OPERATOR ACCESS AREA, the dose rate shall not exceed 1 μSv/h (0,1 mR/h) (see NOTE). Account is taken of the background level.*

NOTE These values appear in Directive 96/29/Euratom. **Ⓒ**

Annex J (normative)

Table of electrochemical potentials (see 2.6.5.6)

Table J.1 – Electrochemical potentials (V)

| Magnesium, magnesium alloys | Zinc, zinc alloys | 80 tin/20 Zn on steel, Zn on iron or steel | Aluminium | Cd on steel | Al/Mg alloy | Mild steel | Duralumin | Lead | Cr on steel, soft solder | Cr on Ni on steel, tin on steel 12 % Cr stainless steel | High Cr stainless steel | Copper, copper alloys | Silver solder, Austenitic stainless steel | Ni on steel | Silver | Rh on Ag on Cu, silver/gold alloy | Carbon | Gold, platinum | |
|-----------------------------|-------------------|--|-----------|-------------|-------------|------------|-----------|------|--------------------------|---|-------------------------|-----------------------|---|-------------|--------|-----------------------------------|--------|----------------|---|
| 0 | 0,5 | 0,55 | 0,7 | 0,8 | 0,85 | 0,9 | 1,0 | 1,05 | 1,1 | 1,15 | 1,25 | 1,35 | 1,4 | 1,45 | 1,6 | 1,65 | 1,7 | 1,75 | Magnesium, magnesium alloys |
| | 0 | 0,05 | 0,2 | 0,3 | 0,35 | 0,4 | 0,5 | 0,55 | 0,6 | 0,65 | 0,75 | 0,85 | 0,9 | 0,95 | 1,1 | 1,15 | 1,2 | 1,25 | Zinc, zinc alloys |
| | | 0 | 0,15 | 0,25 | 0,3 | 0,35 | 0,45 | 0,5 | 0,5 | 0,6 | 0,7 | 0,8 | 0,85 | 0,9 | 1,05 | 1,1 | 1,15 | 1,2 | 80 tin/20 Zn on steel, Zn on iron or steel |
| | | | 0 | 0,1 | 0,15 | 0,2 | 0,3 | 0,35 | 0,4 | 0,45 | 0,55 | 0,65 | 0,7 | 0,75 | 0,9 | 0,95 | 1,0 | 1,05 | Aluminium |
| | | | | 0 | 0,05 | 0,1 | 0,2 | 0,25 | 0,3 | 0,35 | 0,45 | 0,55 | 0,6 | 0,65 | 0,8 | 0,85 | 0,9 | 0,95 | Cd on steel |
| Ag | Silver | | | | 0 | 0,05 | 0,15 | 0,2 | 0,2 | 0,3 | 0,4 | 0,5 | 0,55 | 0,6 | 0,75 | 0,8 | 0,85 | 0,9 | Al/Mg alloy |
| Al | Aluminium | | | | | 0 | 0,1 | 0,15 | 0,2 | 0,25 | 0,35 | 0,45 | 0,5 | 0,55 | 0,7 | 0,75 | 0,8 | 0,85 | Mild steel |
| Cd | Cadmium | | | | | | | | | | | | | | | | | | |
| Cr | Chromium | | | | | | 0 | 0,05 | 0,1 | 0,15 | 0,25 | 0,35 | 0,4 | 0,45 | 0,6 | 0,65 | 0,7 | 0,75 | Duralumin |
| Cu | Copper | | | | | | | | | | | | | | | | | | |
| Mg | Magnesium | | | | | | 0 | 0,5 | 0,1 | 0,2 | 0,3 | 0,35 | 0,4 | 0,55 | 0,6 | 0,66 | 0,7 | | Lead |
| Ni | Nickel | | | | | | | | | | | | | | | | | | |
| Rh | Rhodium | | | | | | | 0 | 0,05 | 0,15 | 0,25 | 0,3 | 0,35 | 0,5 | 0,55 | 0,6 | 0,65 | | Cr on steel, soft solder |
| Zn | Zinc | | | | | | | | | 0 | 0,1 | 0,2 | 0,25 | 0,3 | 0,45 | 0,5 | 0,55 | 0,6 | Cr on Ni on steel, tin on steel 12 % Cr stainless steel |
| | | | | | | | | | | | 0 | 0,1 | 0,15 | 0,2 | 0,35 | 0,4 | 0,45 | 0,5 | High Cr stainless steel |
| | | | | | | | | | | | | 0 | 0,05 | 0,1 | 0,25 | 0,3 | 0,35 | 0,4 | Copper, copper alloys |
| | | | | | | | | | | | | | 0 | 0,15 | 0,2 | 0,25 | 0,3 | 0,35 | Silver solder, Austenitic stainless steel |
| | | | | | | | | | | | | | | 0 | 0,15 | 0,2 | 0,25 | 0,3 | Ni on steel |
| | | | | | | | | | | | | | | | 0 | 0,5 | 0,1 | 0,15 | Silver |
| | | | | | | | | | | | | | | | | 0 | 0,05 | 0,1 | Rh on Ag on Cu, silver/gold alloy |
| | | | | | | | | | | | | | | | | | 0 | 0,5 | Carbon |
| | | | | | | | | | | | | | | | | | | 0 | Gold, platinum |

NOTE Corrosion due to electrochemical action between dissimilar metals that are in contact is minimized if the combined electrochemical potential is below about 0,6 V. In the table the combined electrochemical potentials are listed for a number of pairs of metals in common use; combinations above the dividing line should be avoided.

Annex K (normative)

Thermal controls

(see 1.5.3 and 5.3.8)

K.1 Making and breaking capacity

THERMOSTATS and TEMPERATURE LIMITERS shall have adequate making and breaking capacity.

Compliance is checked by subjecting three samples either to the tests of Clauses K.2 and K.3, or to the tests of K.4, as appropriate. If the component is T-marked, one sample is tested with the switch part at room temperature, and two samples with the switch part at a temperature in accordance with the marking.

Components not marked with individual ratings are tested either in the equipment or separately, whichever is more convenient, but, if tested separately, the test conditions are to be similar to those occurring in the equipment.

During the tests, no sustained arcing shall occur.

After the tests, the samples shall show no damage impairing their further use. Electrical connections shall not have worked loose. The component shall withstand an electric strength test as specified in 5.2.2, except that the test voltage for the insulation between the contacts is twice the voltage applied when the equipment is operated at RATED VOLTAGE or at the upper voltage of the RATED VOLTAGE RANGE.

For test purposes the switching frequency can be increased above the normal switching frequency inherent to the equipment, provided that no greater risk of failure is induced.

If it is not possible to test the component separately, three samples of the equipment in which it is used are tested.

K.2 Thermostat reliability

THERMOSTATS are caused, thermally, to perform 200 cycles of operation (200 makes and 200 breaks) when the equipment is operated at a voltage equal to 110 % of the RATED VOLTAGE or to 110 % of the upper voltage of the RATED VOLTAGE RANGE, and under NORMAL LOAD.

K.3 Thermostat endurance test

THERMOSTATS are caused, thermally, to perform 10 000 cycles of operation (10 000 makes and 10 000 breaks) when the equipment is operated at RATED VOLTAGE or at the upper voltage of the RATED VOLTAGE RANGE, and under NORMAL LOAD.

K.4 Temperature limiter endurance

TEMPERATURE LIMITERS are caused, thermally, to perform 1 000 cycles of operation (1 000 makes and 1 000 breaks) when the equipment is operated at RATED VOLTAGE, or at the upper voltage of the RATED VOLTAGE RANGE, and under NORMAL LOAD.

K.5 Thermal cut-out reliability

THERMAL CUT-OUTS shall operate reliably.

Compliance is checked while the equipment is operating under the conditions specified in 4.5.2.

AUTOMATIC RESET THERMAL CUT-OUTS are caused to operate 200 times; MANUAL RESET THERMAL CUT-OUTS are reset after each operation and thus caused to operate ten times.

After the tests, the samples shall show no damage impairing their further use.

Forced cooling and resting periods are permitted to prevent damage to the equipment.

K.6 Stability of operation

THERMOSTATS, TEMPERATURE LIMITERS and THERMAL CUT-OUTS shall be so constructed that their setting is not changed appreciably by heating, vibration, etc., occurring in normal use.

Compliance is checked by inspection during the abnormal operation tests of 5.3.

Annex L (normative)

Normal load conditions for some types of electrical business equipment

(see 1.2.2.1 and 4.5.2)

L.1 Typewriters

Typewriters are energized with no load applied until steady conditions are established. Manually keyed machines are then operated at a rate of 200 characters per minute, with a line transport operation after each 60 characters including spaces, until steady conditions are established. Automatically operated machines are operated at the maximum typing speed recommended in the manufacturer's instructions.

L.2 Adding machines and cash registers

For adding machines and cash registers, four digit numbers are entered or set and the repeat key or operating bar activated 24 times per minute, until steady conditions are established, the four digit number to be used being that which loads the machine most heavily. If the cash register has a drawer that opens every time an item is rung up, the cash register is operated at a rate of 15 operation cycles per minute, the drawer being shut after each operation, until steady conditions are established. For an adding machine or cash register, an operation consists of the OPERATOR setting or inserting the figures with which the machine is to operate and then pressing the operating bar, repeating key or the like for each operation.

L.3 Erasers

Erasers are operated continuously at no load for 1 h.

L.4 Pencil sharpeners

For a pencil sharpener, five new pencils are each sharpened eight times according to the following timetable. Except for new pencils, the point is broken off before each sharpening.

| | |
|-------------------------------------|--|
| <i>Sharpening period</i> | <i>4 s for a new pencil</i> <i>2 s for subsequent sharpenings</i> |
| <i>Interval between sharpenings</i> | <i>6 s</i> |
| <i>Interval between pencils</i> | <i>60 s</i> |

All times are approximate.

L.5 Duplicators and copy machines

Duplicators and copy machines are operated continuously at maximum speed until steady conditions are established. It is permitted to introduce a rest period of 3 min after each 500 copies if this is compatible with the design of the machine.

L.6 Motor-operated files

Motor-operated files are loaded to simulate a condition of unbalance caused by uneven distribution of the contents. During operation, the unbalanced load is moved approximately one-third of the total carrier travel of the path that will impose maximum loading during each operation. The operation is repeated each 15 s until steady conditions are established.

A load caused by the non-uniform distribution of the contents is permitted to be simulated as follows.

In the case of vertical transport, three-eighths of the filing area are to be loaded, without leaving clearances, with three-eighths of the admissible load. The entire transport way is to be travelled with this load. The transport cycle is to be repeated, at intervals of 10 s, until the temperature has stabilized.

In the case of a different transport, for example, horizontal or circular mode of transport, the total load is moved over the whole transport way. The transport cycle is to be repeated, at intervals of 15 s, until the temperature has stabilized.

L.7 Other business equipment

Other business equipment is operated according to the most unfavourable way of operation given in the operating instructions.

Annex M (normative)

Criteria for telephone ringing signals

(see 2.3.1)

M.1 Introduction

The two alternative methods described in this annex reflect satisfactory experience in different parts of the world. Method A is typical of analogue telephone networks in Europe, and Method B of those in North America. The two methods result in standards of electrical safety that are broadly equivalent.

M.2 Method A

This method requires that the currents I_{TS1} and I_{TS2} flowing through a 5 000 Ω resistor, between any two conductors or between one conductor and earth do not exceed the limits specified, as follows.

a) For normal operation, I_{TS1} , the current determined from the calculated or measured current for any single active ringing period t_1 (as defined in Figure M.1), does not exceed:

- 1) for cadenced ringing ($t_1 < \infty$), the current given by the curve of Figure M.2 at t_1 ;
- 2) for continuous ringing ($t_1 = \infty$), 16 mA.

I_{TS1} , in mA, is as given by

$$I_{TS1} = \frac{I_p}{\sqrt{2}} \quad \text{for } (t_1 \leq 600 \text{ ms})$$

$$I_{TS1} = \frac{t_1 - 600}{600} \times \frac{I_{pp}}{2\sqrt{2}} + \frac{1\,200 - t_1}{600} \times \frac{I_p}{\sqrt{2}} \quad \text{for } (600 \text{ ms} < t_1 < 1\,200 \text{ ms})$$

$$I_{TS1} = \frac{I_{pp}}{2\sqrt{2}} \quad \text{for } (t_1 \geq 1\,200 \text{ ms})$$

where

I_p is the peak current, in mA, of the relevant waveform given in Figure M.3;

I_{pp} is the peak-to-peak current, in mA, of the relevant waveform given in Figure M.3;

t_1 is expressed in ms.

b) For normal operation, I_{TS2} , the average current for repeated bursts of a cadenced ringing signal calculated for one ringing cadence cycle t_2 (as defined in Figure M.1), does not exceed 16 mA r.m.s.

I_{TS2} in mA is as given by

$$I_{TS2} = \frac{t_1}{t_2} \times I_{TS1}^2 + \frac{t_2 - t_1}{t_2} \times \frac{I_{dc}^2}{3,75^2}^{1/2}$$

where

I_{TS1} in mA, is as given by item a) of Clause M.2;

I_{dc} is the d.c. current in mA flowing through the 5 000 Ω resistor during the non-active period of the cadence cycle;

t_1 and t_2 are expressed in milliseconds.

NOTE The frequencies of telephone ringing voltages are normally within the range of 14 Hz to 50 Hz.

c) Under single fault conditions, including where cadenced ringing becomes continuous:

- I_{TS1} shall not exceed the current given by the curve of Figure M.2, or 20 mA, whichever is greater;
- I_{TS2} shall not exceed a limit of 20 mA.

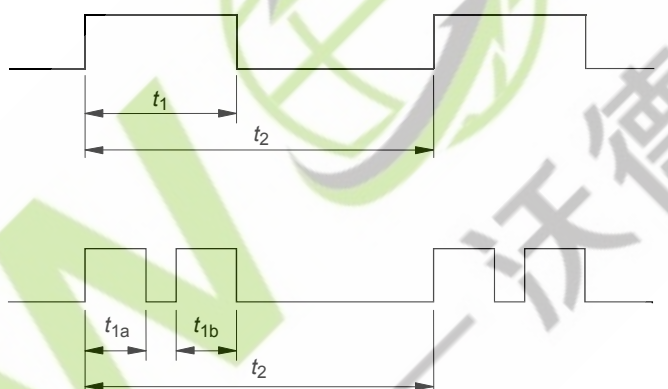

IEC 1584/05

t_1 is:

- the duration of a single ringing period, where the ringing is active for the whole of the single ringing period;
- the sum of the active periods of ringing within the single ringing period, where the single ringing period contains two or more discrete active periods of ringing, as in the example shown, for which $t_1 = t_{1a} + t_{1b}$.

t_2 is the duration of one complete cadence cycle.

Figure M.1 – Definition of ringing period and cadence cycle

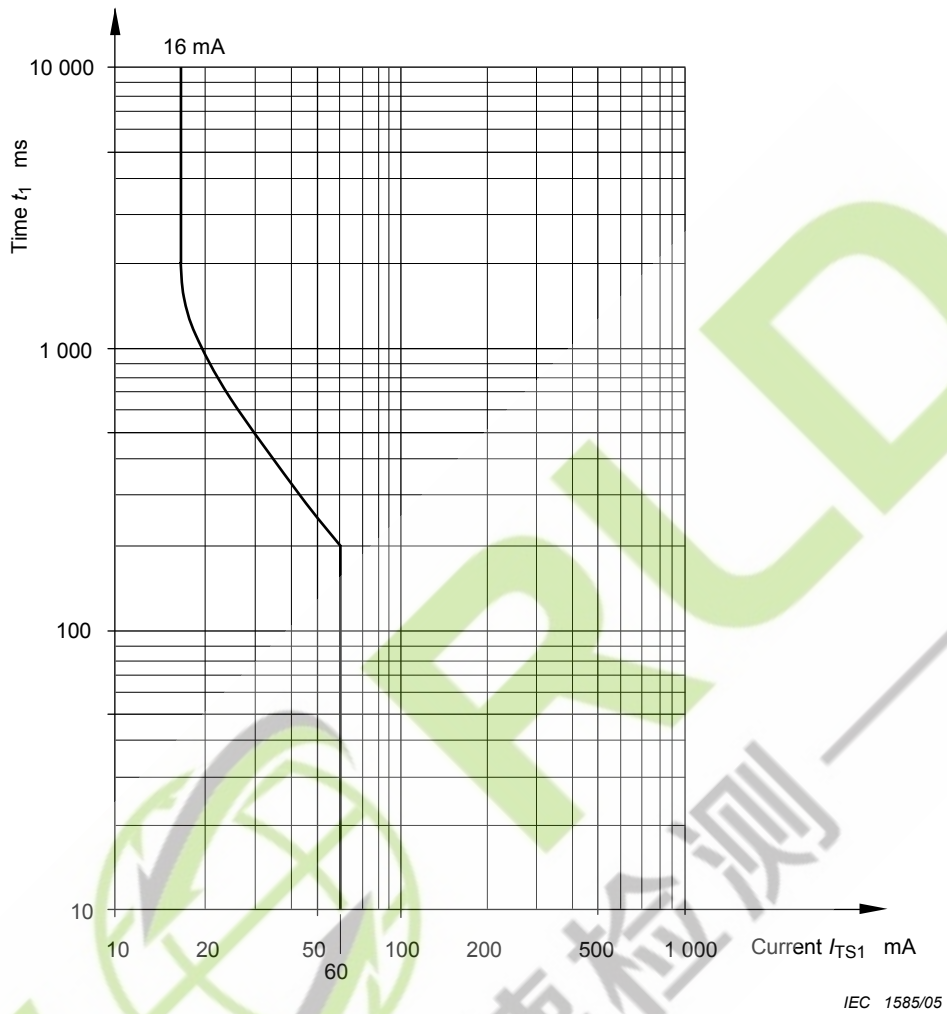

Figure M.2 – I_{TS1} limit curve for cadenced ringing signal

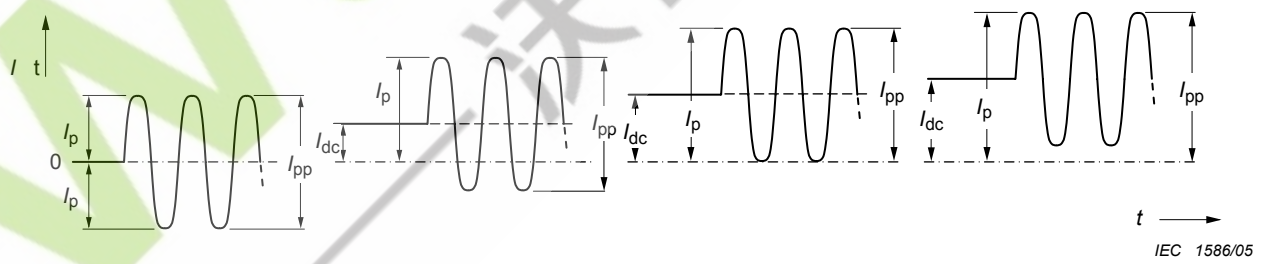

Figure M.3 – Peak and peak-to-peak currents

M.3 Method B

NOTE This method is aligned with USA CFR 47 ("FCC Rules") Part 68, Sub-part D, with additional requirements that apply under fault conditions.

M.3.1 Ringing signal

M.3.1.1 Frequency

The ringing signal shall use only frequencies whose fundamental component is equal to or less than 70 Hz.

M.3.1.2 Voltage

The ringing voltage shall be less than 300 V peak-to-peak and less than 200 V peak with respect to earth, measured across a resistance of at least 1 M Ω .

M.3.1.3 Cadence

The ringing voltage shall be interrupted to create quiet intervals of at least 1 s duration separated by no more than 5 s. During the quiet intervals, the voltage to earth shall not exceed 60 V d.c.

M.3.1.4 Single fault current

Where cadenced ringing becomes continuous as a consequence of a single fault, the current through a 5 000 Ω resistor connected between any two output conductors or between one output conductor and earth shall not exceed 56,5 mA peak-to-peak, as shown in Figure M.3.

M.3.2 Tripping device and monitoring voltage

M.3.2.1 Conditions for use of a tripping device or a monitoring voltage

A ringing signal circuit shall include a tripping device as specified in M.3.2.2, or provide a monitoring voltage as specified in M.3.2.3, or both, depending on the current through a specified resistance connected between the ringing signal generator and earth, as follows:

- if the current through any resistor of 500 Ω or greater, does not exceed 100 mA peak-to-peak, neither a tripping device nor a monitoring voltage is required;
- if the current through any resistor of 1 500 Ω or greater, exceeds 100 mA peak-to-peak, a tripping device shall be included. If the tripping device meets the trip criteria specified in Figure M.4 with any resistor of $R = 500 \Omega$ or greater, no monitoring voltage is required. If, however, the tripping device only meets the trip criteria with any resistor of $R = 1 500 \Omega$ or greater, a monitoring voltage shall also be provided;
- if the current through any resistor of 500 Ω or greater, exceeds 100 mA peak-to-peak, but the current through any resistor of 1 500 Ω or greater, does not exceed this value, either:
 - a tripping device shall be provided, meeting the trip criteria specified in Figure M.4 with any resistor of $R = 500 \Omega$ or greater, or
 - a monitoring voltage shall be provided.

NOTE 1 Tripping devices are, in general, current-sensitive and do not have a linear response, due to the resistance/current characteristics and time delay/response factor in their design.

NOTE 2 In order to minimize testing time, a variable resistor box should be used.

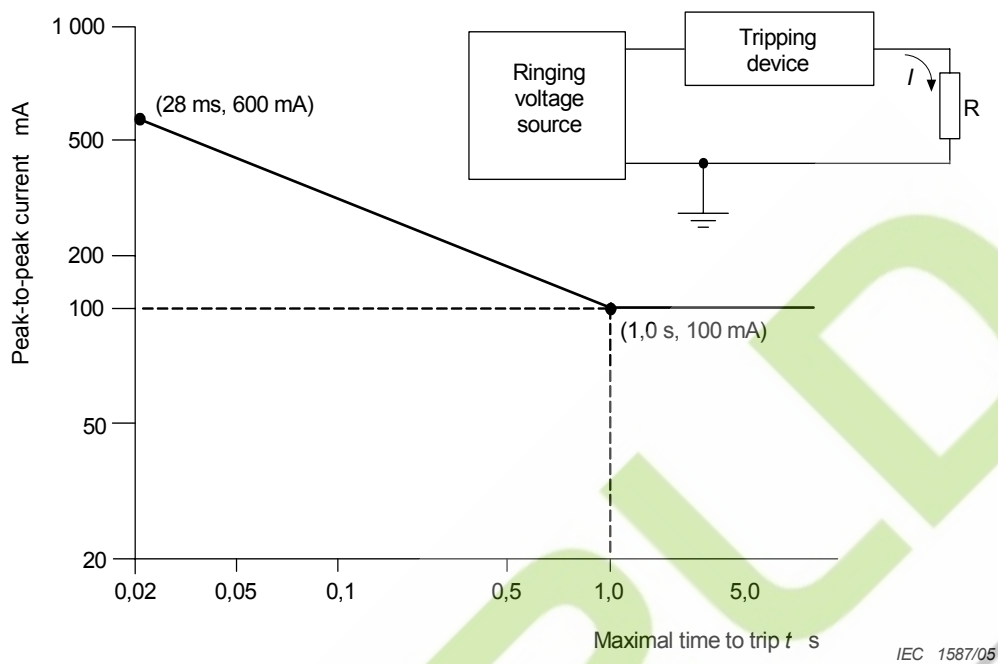

NOTE 1 t is measured from the time of connection of the resistor R to the circuit.

NOTE 2 The sloping part of the curve is defined as $I = 100 / \sqrt{t}$.

Figure M.4 – Ringing voltage trip criteria

M.3.2.2 Tripping device

A series current-sensitive tripping device in the ringlead that will trip ringing as specified in Figure M.4.

M.3.2.3 Monitoring voltage

A voltage to earth on the tip or ring conductor with a magnitude of at least 19 V peak, but not exceeding 60 V d.c., whenever the ringing voltage is not present (idle state).

Annex N (normative)

Impulse test generators

(see 1.5.7.2, 1.5.7.3, 2.10.3.9, 6.2.2.1, 7.4.2, 7.4.3 and Clause G.5)

NOTE Extreme care is necessary when using these test generators due to the high electric charge stored in the capacitor C_1 .

N.1 ITU-T impulse test generators

The circuit in Figure N.1, using the component values in references 1 and 2 of Table N.1, is used to generate impulses, the C_1 capacitor being charged initially to a voltage U_c .

Circuit reference 1 of Table N.1 generates 10/700 μs impulses (10 μs virtual front time, 700 μs virtual time to half value) as specified in ITU-T Recommendation K.44 to simulate lightning interference in the TELECOMMUNICATION NETWORK.

Circuit reference 2 of Table N.1 generates 1,2/50 μs impulses (1,2 μs virtual front time, 50 μs virtual time to half value) as specified in ITU-T Recommendation K.44 to simulate transients in power distribution systems.

The impulse wave shapes are under open-circuit conditions and can be different under load conditions.

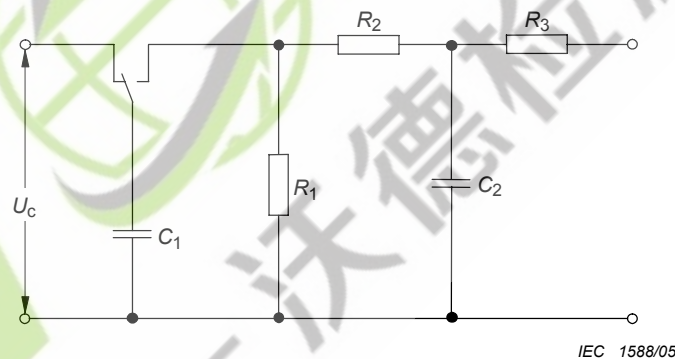

Figure N.1 – ITU-T impulse test generator circuit

N.2 IEC 60065 impulse test generator

The circuit in Figure N.2, using the component values reference 3 in Table N.1, is used to generate impulses, the C_1 capacitor being charged initially to a voltage U_c . The switch used in Figure N.2 is a critical part of the circuit. See 10.1 of IEC 60065, for further information.

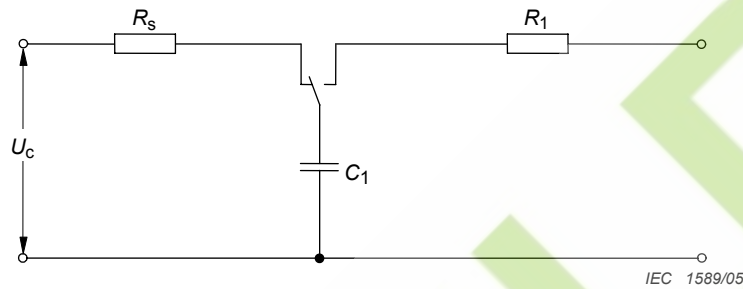

Figure N.2 – IEC 60065 impulse test generator circuit

Table N.1 – Component values for Figures N.1 and N.2

| Reference | Test impulse | Figure | C_1 | C_2 | R_1 | R_2 | R_3 | R_s | See |
|----------------|----------------|--------|------------|-------------|--------------|-------------|-------------|---------------|---|
| 1 ^a | 10/700 μ s | N.1 | 20 μ F | 0,2 μ F | 50 Ω | 15 Ω | 25 Ω | – | 1.5.7.3, 2.10.3.9, 6.2.2.1, 7.4.3 and item b) of Clause G.5 |
| 2 ^b | 1,2/50 μ s | N.1 | 1 μ F | 30 nF | 76 Ω | 13 Ω | 25 Ω | – | 1.5.7.2, 2.10.3.9 and item a) of Clause G.5 |
| 3 ^c | – | N.2 | 1 nF | – | 1 k Ω | – | – | 15 M Ω | 1.5.7.3 and 7.4.2 |

^a Reference 1 impulse is typical of voltages induced into telephone wires and coaxial cables in long outdoor cable runs by nearby lightning strikes to earth.

^b Reference 2 impulse is typical of earth potential rises caused either by lightning strikes to power lines or by power line faults.

^c Reference 3 impulse is typical of voltages induced into antenna system wiring caused by nearby lightning strikes to earth.

Annex P (normative)

Normative references

The following reference documents are indispensable for the application of this standard. If the date of the reference document is given, only that edition applies, excluding any subsequent corrigenda and amendments. For undated references, the latest edition of the referenced document applies, including any corrigenda and amendments.

Further information on the reference documents, including how to obtain copies, can be found on the following internet sites:

<http://www.iec.ch>
<http://www.iso.org>
<http://www.itu.int>

For the locations in the standard where these documents are mentioned, see the Index.

IEC 60065:2001:, *Audio, video and similar electronic apparatus – Safety requirements* Amendment 1²⁾

IEC 60068-2-78, *Environmental testing – Part 2-78: Tests – Test Cab: Damp heat, steady state*

IEC 60073, *Basic and safety principles for man-machine interface, marking and identification – Coding principles for indicators and actuators*

IEC 60083, *Plugs and socket-outlets for domestic and similar general use standardized in member countries of IEC*

IEC 60085:2004, *Electrical Insulation – Thermal classification*

IEC 60112, *Method for determination of the proof and the comparative tracking indices of insulating materials*

IEC 60216-4-1, *Guide for the determination of thermal endurance properties of electrical insulating materials – Part 4: Ageing ovens – Section 1: Single-chamber ovens*

IEC 60227 (all parts), *Polyvinyl chloride insulated cables of rated voltages up to and including 450/750 V*

IEC 60245 (all parts), *Rubber insulated cables – Rated voltages up to and including 450/750 V*

IEC 60309 (all parts), *Plugs, socket-outlets and couplers for industrial purposes*

IEC 60317 (all parts), *Specifications for particular types of winding wires*

²⁾ To be published.

IEC 60317-43, *Specifications for particular types of winding wires – Part 43: Aromatic polyimide tape wrapped round copper wire, class 240*

IEC 60320 (all parts), *Appliance couplers for household and similar general purposes*

IEC 60364-1:2001, *Electrical installations of buildings - Part 1: Fundamental principles, assessment of general characteristics, definitions*

IEC 60384-14:1993, *Fixed capacitors for use in electronic equipment – Part 14: Sectional specification: Fixed capacitors for electromagnetic interference suppression and connection to the supply mains*
Amendment 1 (1995)

IEC 60417-DB:2002³⁾, *Graphical symbols for use on equipment*

IEC 60664-1:1992, *Insulation coordination for equipment within low-voltage systems – Part 1: Principles, requirements and tests*⁴⁾
Amendment 1 (2000)
Amendment 2 (2002)

IEC 60695-2-11, *Fire hazard testing – Part 2-11: Glowing/hot-wire based test methods – Glow-wire flammability test method for end-products*

IEC 60695-2-20, *Fire hazard testing – Part 2-20: Glowing/hot wire based test methods – Hot-wire coil ignitability - Apparatus, test method and guidance*

IEC 60695-10-2, *Fire hazard testing – Part 10-2: Abnormal heat – Ball pressure test*

IEC 60695-11-3, *Fire hazard testing – Part 11-3: Test flames – 500 W flames – Apparatus and confirmational test methods*

IEC 60695-11-4, *Fire hazard testing – Part 11-4: Test flames – 50 W flames – Apparatus and confirmational test methods*

IEC 60695-11-5:2004, *Fire hazard testing – Part 11-5: Test flames – Needle-flame test method – Apparatus, confirmatory test arrangement and guidance*

IEC 60695-11-10, *Fire hazard testing – Part 11-10: Test flames – 50 W horizontal and vertical flame test methods*

IEC 60695-11-20, *Fire hazard testing – Part 11-20: Test flames – 500 W flame test methods*

IEC 60730-1:1999, *Automatic electrical controls for household and similar use – Part 1: General requirements*⁵⁾
Amendment 1 (2003)

3) “DB” refers to the IEC on-line database.

4) A consolidated edition 1.2 exists, including IEC 60664-1:1992 and its Amendments 1 (2000) and 2 (2002).

5) A consolidated edition 3.1 exists, including IEC 60730-1:1999 and its Amendment 1 (2003).

IEC 60747-5-5, ⁶⁾ *Discrete semiconductor devices – Part 5-5: Optoelectronic devices – Photocouplers, optocouplers*

IEC 60825-1, *Safety of laser products – Part 1: Equipment classification, requirements and user's guide*

IEC 60825-2, *Safety of laser products – Part 2: Safety of optical fibre communication systems*

IEC 60825-9, *Safety of laser products – Part 9: Compilation of maximum permissible exposure to incoherent optical radiation*

IEC 60825-12, *Safety of laser products - Part 12: Safety of free space optical communication systems used for transmission of information*

IEC 60851-3:1996, *Winding wires – Test methods – Part 3: Mechanical properties*⁷⁾
Amendment 1 (1997)

IEC 60851-5:1996, *Winding wires – Test methods – Part 5: Electrical properties*⁸⁾
Amendment 1 (1997)
Amendment 2 (2004)

IEC 60851-6:1996, *Winding wires - Test methods – Part 6: Thermal properties*

IEC 60885-1:1987, *Electrical test methods for electric cables – Part 1: Electrical tests for cables, cords and wires for voltages up to and including 450/750 V*

IEC 60906-1, *IEC system of plugs and socket-outlets for household and similar purposes – Part 1: Plugs and socket-outlets 16 A 250 V a.c.*

IEC 60906-2, *IEC system of plugs and socket-outlets for household and similar purposes – Part 2: Plugs and socket-outlets 15 A 125 V a.c.*

IEC 60947-1:2004, *Low voltage switchgear and control gear - Part 1: General rules*

IEC 60990:1999, *Methods of measurement of touch current and protective conductor current*

IEC 61051-2:1991, *Varistors for use in electronic equipment – Part 2: Sectional specification for surge suppression varistors*

IEC 61058-1:2000, *Switches for appliances – Part 1: General requirements*

ISO 178, *Plastics – Determination of flexural properties*

ISO 179 (all parts), *Plastics – Determination of Charpy impact properties*

ISO 180, *Plastics – Determination of Izod impact strength*

6) To be published.

7) A consolidated edition 2.1 exists, including IEC 60851-3:1996 and its Amendment 1 (1997).

8) A consolidated edition 3.2 exists, including IEC 60851-5:1996 and its Amendments 1 (1997) and 2 (2004).

ISO 261, *ISO General-purpose metric screw threads – General plan*

ISO 262, *ISO General-purpose metric screw threads – Selected sizes for screws, bolts and nuts*

ISO 527 (all parts), *Plastics – Determination of tensile properties*

ISO 3864 (all parts), *Graphical symbols – Safety colours and safety signs*

ISO 4892-1, *Plastics – Methods of exposure to laboratory light sources – Part 1: General guidance*

ISO 4892-2, *Plastics – Methods of exposure to laboratory light sources – Part 2: Xenon-arc sources*

ISO 4892-4, *Plastics, Methods of exposure to laboratory light sources – Part 4: Open-flame carbon-arc lamps*

ISO 7000-DB:2004⁹⁾, *Graphical symbols for use on equipment – Index and synopsis*

ISO 8256, *Plastics – Determination of tensile-impact strength*

ISO 9772, *Cellular plastics – Determination of horizontal burning characteristics of small specimens subjected to a small flame*

ISO 9773, *Plastics – Determination of burning behaviour of thin flexible vertical specimens in contact with a small-flame ignition source*

ITU-T Recommendation K.44, *Resistibility tests for telecommunication equipment exposed to overvoltages and overcurrents – Basic Recommendation*

9) “DB” refers to the IEC and ISO on-line database.

Annex Q
(normative)

Voltage dependent resistors (VDRs)

(see 1.5.9.1)

A VDR used in a PRIMARY CIRCUIT shall comply with IEC 61051-2, with the following details.

a) Preferred climatic categories (2.1.1 of IEC 61051-2)

Lower category temperature: - 10 °C

Upper category temperature: + 85 °C

Duration of damp heat, steady state test: 21 days

b) Maximum continuous voltage (2.1.2 of IEC 61051-2)

The maximum continuous a.c. voltage is selected from the list of preferred voltages and shall be at least 120 % of

- the RATED VOLTAGE of the equipment or
- the upper voltage of the RATED VOLTAGE RANGE of the equipment.

c) Pulse current (Table I group 1 of IEC 61051-2)

Combination pulses of 6 kV/3 kA of alternating polarity are used, having a pulse shape of 1,2/50 µs for voltage and 8/20 µs for current.

In addition to the performance requirements of Table I group 1, the clamping voltage after the test shall not have changed by more than 10 % when measured with the manufacturer's specified current.

Annex R (informative)

Examples of requirements for quality control programmes

NOTE This annex gives examples of requirements for quality control programmes as specified in 2.10.6.2 for minimum separation distances for coated printed boards and in 2.10.3 and Clause G.2 for reduced CLEARANCES.

R.1 Minimum separation distances for unpopulated coated printed boards (see 2.10.6.2)

A manufacturer wishing to use the reduced separation distances permitted by 2.10.6.2, Table 2Q, shall implement a quality control programme for those features of the boards that are listed in Table R.1. This programme shall include specific quality controls for the tools and materials that affect conductor spacing, adequate inspection of pattern and spacing, cleanliness, coating thickness, electrical tests for short-circuits, insulation resistance and electric withstand voltage.

The manufacturer shall also identify and plan the protection and, where applicable, installation processes that directly affect quality and shall ensure that these processes are conducted under controlled conditions. Controlled conditions shall include the following:

- documented work instructions defining process, equipment, environment and manner of production where the absence of such instructions would adversely affect quality, use of suitable production and installation equipment, suitable working environment, compliance with reference standards, specifications and quality plans;
- monitoring and control of suitable processes and product characteristics during production and installation in the equipment;
- criteria for workmanship stipulated to the extent necessary in written specifications or by means of representative samples;
- records maintained for qualified processes, equipment and personnel as appropriate.

Table R.1 provides the sampling plan for attributes and tests necessary to conform to the requirements of 2.10.6.2. The number of samples of production boards shall be based on IEC 60410 or ISO 2859-1 or equivalent national standards.

Table R.1 – Rules for sampling and inspection – coated printed boards

| Tests | BASIC INSULATION | SUPPLEMENTARY INSULATION | REINFORCED INSULATION |
|--|------------------------|--------------------------|---|
| Spacing mm ^a | Sampling S2 AQL 1,0 | Sampling S2 AQL 1,0 | Sampling S2 AQL 1,0 |
| Electric strength test ^b | Sampling S2 AQL 2,5 | Sampling S2 AQL 2,5 | ROUTINE TEST; one failure requires evaluation for cause |
| Abrasion resistance | Sampling S1 AQL 2,5 | Sampling S1 AQL 2,5 | Sampling S1 AQL 2,5 |
| Thermal ageing ^c | Sampling S3 AQL 4 | Sampling S3 AQL 4 | Sampling S3 AQL 4 |
| Thermal cycling ^c | Sampling S1 AQL 1,5 | Sampling S1 AQL 1,5 | Sampling S1 AQL 1,5 |
| Insulation resistance ^d | Sampling S2 AQL 2,5 | Sampling S2 AQL 2,5 | Sampling S2 AQL 2,5 |
| Visual inspection of coating ^e | ROUTINE TEST | ROUTINE TEST | ROUTINE TEST |

^a To minimize test and inspection time, it is permitted to replace measurement of separation distances by measurement of breakdown voltage. Initially the breakdown voltage is established for ten uncoated boards for which the correct spacing measurements have been confirmed. The breakdown voltage of subsequent uncoated production boards is then checked against a lower limit equal to the minimum breakdown voltage for the ten initial boards minus 100 V. If breakdown occurs at this lower limit, a board is considered a failure unless direct measurement of the spacing conforms with the requirement.

^b The electric strength test shall be conducted according to 5.2.2 except that the duration shall be 1 s to 5 s.

^c The thermal ageing and thermal cycling tests shall be done whenever the type of coating material, printed board material, or the process is changed. It is recommended that it should be done at least once a year.

^d The insulation resistance shall be not less than 1 000 MΩ.

^e Visual inspection without optical magnification or automated optical inspection with equivalent resolution shall show no cracks, no bubbles, no pinholes, or detachment of the coating in the area of reduced spacings. Any such defects shall be reason for rejection of the printed board.

R.2 Reduced clearances (see 2.10.3)

A manufacturer wishing to use reduced CLEARANCES permitted by 2.10.3, Tables 2J, 2K, 2L and G.2, shall implement a quality control programme for those features of the construction listed in Table R.2. This programme shall include specific quality controls for the tools and materials that affect CLEARANCES.

The manufacturer shall also identify and plan the protection and, where applicable, installation processes that directly affect quality and shall ensure that these processes are conducted under controlled conditions. Controlled conditions shall include the following:

- documented work instructions defining process, equipment, environment, and manner of production where the absence of such instructions would adversely affect quality, suitable working environment, compliance with reference standards or specifications and quality plans;
- monitoring and control of suitable processes and product characteristics during production and installation in the equipment;
- criteria for workmanship stipulated to the extent necessary in written specifications or by means of representative samples;
- records maintained for qualified processes, equipment and personnel as appropriate.

Table R.2 provides the sampling plan for attributes and tests necessary to conform to the requirements of 2.10.3. The number of samples of production parts or assemblies shall be based on IEC 60410 or ISO 2859-1 or equivalent national standards.

Table R.2 – Rules for sampling and inspection – reduced clearances

| Tests | BASIC INSULATION | SUPPLEMENTARY INSULATION | REINFORCED INSULATION |
|--|----------------------|--------------------------|---|
| CLEARANCE ^a | Sampling S2 AQL 4 | Sampling S2 AQL 4 | Sampling S2 AQL 4 |
| Electric strength test ^b | No test | No test | ROUTINE TEST; one failure requires evaluation for cause |
| <p>^a To minimize test and inspection time, it is permitted to replace measurement of CLEARANCES by measurement of breakdown voltage. Initially the breakdown voltage is established for ten samples for which the correct CLEARANCE measurements have been confirmed. The breakdown voltage of subsequent parts or assemblies is then checked against a lower limit equal to the minimum breakdown voltage of the initial ten samples minus 100 V. If breakdown occurs at this lower limit, a part or assembly is considered a failure unless direct measurement of the CLEARANCE conforms to the requirement.</p> <p>^b The electric strength test for REINFORCED INSULATION shall consist of one of the following alternatives:</p> <ul style="list-style-type: none"> - six impulses of alternating polarity, using a 1,2/50 μs impulse with a magnitude equal to the peak of the test voltage in accordance with 5.2.2; - a three cycle pulse of a.c. power frequency with a magnitude equal to the test voltage in accordance with 5.2.2; - six impulses of alternating polarity, using 10 ms d.c. impulses with a magnitude equal to the peak of the test voltage in accordance with 5.2.2. | | | |

Annex S (informative)

Procedure for impulse testing

(see 6.2.2.3)

S.1 Test equipment

Impulse generator according to Annex N.

Storage oscilloscope with a bandwidth of a few MHz.

High voltage probe with compensating elements.

S.2 Test procedure

Apply the required number of impulses to the equipment under test and record the waveform patterns.

Examples are given in S.3 to assist in judging whether or not a surge suppressor has operated or insulation has broken down.

S.3 Examples of waveforms during impulse testing

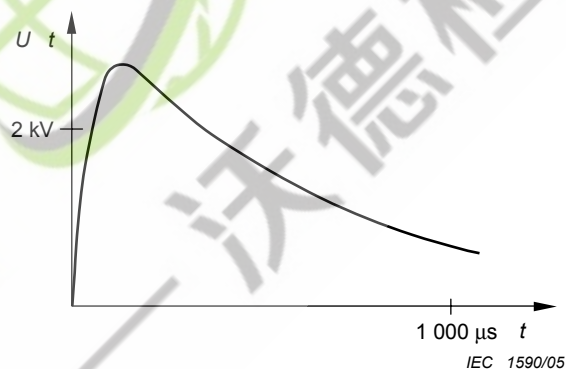

Consecutive impulses are identical in their waveforms.

Figure S.1 – Waveform on insulation without surge suppressors and no breakdown

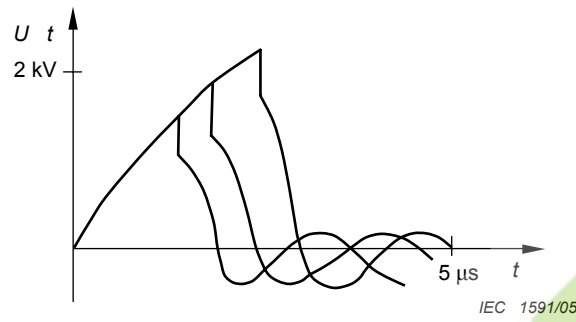

Consecutive impulses are not identical in their waveforms. The pulse shape changes from pulse to pulse until a stable resistance path through the insulation is established. Breakdown can be seen clearly on the shape of the pulse voltage oscillogram.

Figure S.2 – Waveforms on insulation during breakdown without surge suppressors

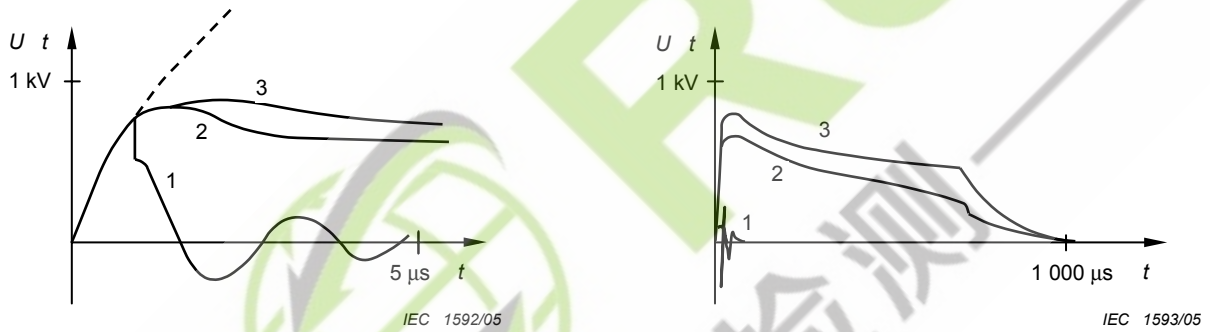

- 1 – gas discharge type
- 2 – semiconductor type
- 3 – metal oxide type

Consecutive impulses are identical in their waveforms.

Figure S.3 – Waveforms on insulation with surge suppressors in operation

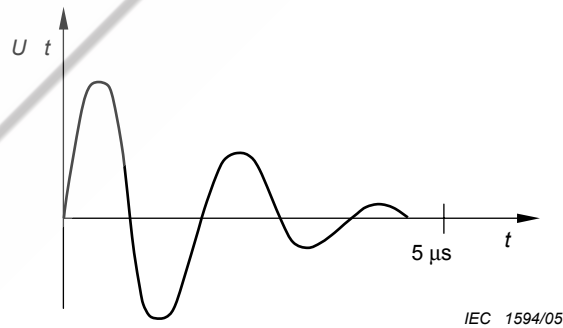

Figure S.4 – Waveform on short-circuited surge suppressor and insulation

Annex T (informative)

Guidance on protection against ingress of water

(see 1.1.2)

When the intended application is such that ingress of water is possible, an appropriate degree of protection other than IPX0 should be selected by the manufacturer from IEC 60529, an extract from which is included in this annex.

Additional design features should then be included to ensure that ingress of water does not affect insulation.

IEC 60529 gives test conditions for each degree of protection other than IPX0. The conditions appropriate to the selected degree of protection should be applied to the equipment, immediately followed by an electric strength test as specified in 5.2.2 on any insulation that may have become wet, and inspection should show that water has not created a risk of personal injury or fire. In particular, there should be no trace of water on insulation that is not designed to operate when wet.

If the equipment is provided with drain holes, inspection should show that any water that enters does not accumulate and that it drains away without affecting compliance.

If the equipment is not provided with drain holes, account should be taken of the possibility of build-up of water.

Where equipment is only partly exposed to water, for example, when it is to be installed through an opening in an outside wall, only the exposed parts should be subjected to the IEC 60529 test conditions. For these tests, such equipment should be installed in an appropriate test assembly, simulating actual conditions of installation according to the installation instructions, including the use of a kit of sealing parts where required.

It should not be possible to remove, without the aid of a TOOL, parts that ensure the required degree of protection against ingress of water.

The information in Table T.1 is extracted from IEC 60529.

Table T.1 – Extract from IEC 60529

| Second characteristic numeral | Degree of protection | |
|-------------------------------|--|--|
| | Brief description | Definition |
| 0 | Non-protected | – |
| 1 | Protected against vertically falling water drops | Vertically falling water drops shall have no harmful effects |
| 2 | Protected against vertically falling water drops when enclosure tilted up to 15° | Vertically falling drops shall have no harmful effects when the enclosure is tilted at any angle up to 15° on either side of the vertical |
| 3 | Protected against spraying water | Water sprayed at an angle up to 60° on either side of the vertical shall have no harmful effects |
| 4 | Protected against splashing water | Water splashed against the enclosure from any direction shall have no harmful effects |
| 5 | Protected against water jets | Water projected in jets against the enclosure from any direction shall have no harmful effects |
| 6 | Protected against powerful water jets | Water projected in powerful jets against the enclosure from any direction shall have no harmful effects |
| 7 | Protected against the effects of temporary immersion in water | Ingress of water in quantities causing harmful effects shall not be possible when the enclosure is temporarily immersed in water under standardized conditions of pressure and time |
| 8 | Protected against the effects of continuous immersion in water | Ingress of water in quantities causing harmful effects shall not be possible when the enclosure is continuously immersed in water under conditions which shall be agreed between the manufacturer and user but that are more severe than for numeral 7 |

Annex U (normative)

Insulated winding wires for use without interleaved insulation

(see 2.10.5.4)

This annex specifies winding wire whose insulation may be used to provide BASIC INSULATION, SUPPLEMENTARY INSULATION, DOUBLE INSULATION or REINFORCED INSULATION in wound components without interleaved insulation.

This annex covers round winding wires having diameters between 0,05 mm and 5,00 mm.

U.1 Wire construction

If the wire is insulated with overlapping spirally wrapped tape, the overlap shall be adequate to ensure continued overlap during manufacture of the wound component. The overlaps shall be sufficiently secured to maintain the amount of overlap.

U.2 Type tests

The wire shall pass the tests of U.2.1 to U.2.4, conducted at a temperature between 15 °C and 35 °C and a relative humidity between 45 % and 75 %, unless specified otherwise.

U.2.1 Electric strength

The test sample is prepared according to 4.4.1 of IEC 60851-5, (for a twisted pair). The sample is then subjected to the test of 5.2.2 of this standard. The test voltage shall be not less than twice the appropriate voltage in accordance with 5.2.2 of this standard, with a minimum of

- 3 000 V a.c. r.m.s. for BASIC INSULATION or SUPPLEMENTARY INSULATION, or
- 6 000 V a.c. r.m.s. for REINFORCED INSULATION.

U.2.2 Flexibility and adherence

Test 8 in 5.1.1 of IEC 60851-3 is applied using the mandrel diameters of Table U.1. The test sample is then examined in accordance with 5.1.1.4 of IEC 60851-3, followed by the test of 5.2.2 of this standard except that the test voltage is applied between the wire and the mandrel. The test voltage shall be not less than the appropriate voltage in accordance with 5.2.2 of this standard, with a minimum of

- 1 500 V a.c. r.m.s. for BASIC INSULATION or SUPPLEMENTARY INSULATION, or
- 3 000 V a.c. r.m.s. for REINFORCED INSULATION.

Table U.1 – Mandrel diameter

| Nominal conductor diameter mm | Mandrel diameter mm ± 0,2 mm |
|----------------------------------|--|
| 0,05 – 0,34 | 4,0 |
| 0,35 – 0,49 | 6,0 |
| 0,50 – 0,74 | 8,0 |
| 0,75 – 2,49 | 10,0 |
| 2,50 – 5,00 | four times the nominal conductor diameter ^a |

^a In accordance with IEC 60317-43.

The tension to be applied to the wire during winding on the mandrel is calculated from the wire diameter to be equivalent to 118 MPa ± 10 % (118 N/mm² ± 10 %).

U.2.3 Heat shock

Test 9 of IEC 60851-6, followed by the electric strength test of 5.2.2 of this standard except that the test voltage is applied between the wire and the mandrel. The voltage shall be not less than the appropriate voltage in accordance with 5.2.2 of this standard, with a minimum of

- 1 500 V a.c. r.m.s. for BASIC INSULATION or SUPPLEMENTARY INSULATION, or
- 3 000 V a.c. r.m.s. for REINFORCED INSULATION.

The oven temperature is the relevant temperature for the thermal class of insulation in Table U.2.

The mandrel diameter and tension applied to the wire during winding on the mandrel are as in U.2.2.

The electric strength test is conducted at room temperature after removal from the oven.

Table U.2 – Oven temperature

| Thermal class | Oven temperature °C ± 5 °C |
|---------------|-------------------------------|
| 105 (A) | 200 |
| 120 (E) | 215 |
| 130 (B) | 225 |
| 155 (F) | 250 |
| 180 (H) | 275 |
| 200 | 295 |
| 220 | 315 |
| 250 | 345 |

The designations A to H, formerly assigned in IEC 60085 to thermal classes 105 to 180, are given in parentheses.

U.2.4 Retention of electric strength after bending

Five samples are prepared as in U.2.2 above and tested as follows. Each sample is removed from the mandrel, placed in a container and positioned so that it can be surrounded by at least 5 mm of metal shot. The ends of the conductor in the sample shall be sufficiently long to avoid flash over. The shot shall be not more than 2 mm in diameter and shall consist of balls of stainless steel, nickel or nickel plated iron. The shot is gently poured into the container until the sample under test is covered by at least 5 mm of shot. The shot shall be cleaned periodically with a suitable solvent (for example, 1,1,1-trichloroethane).

NOTE The above test procedure is reproduced from 4.6.1 c) of IEC 60851-5 (second edition including amendment 1), now withdrawn. It is not included in the third edition of that standard.

The test voltage shall be not less than the appropriate test voltage in accordance with 5.2.2 of this standard, with a minimum of

- 1 500 V a.c. r.m.s. for BASIC INSULATION or SUPPLEMENTARY INSULATION, or
- 3 000 V a.c. r.m.s. for REINFORCED INSULATION.

The test voltage is applied between the shot and the conductor.

The mandrel diameter and tension applied to the wire during winding on the mandrel are as in U.2.2.

U.3 Tests during manufacture

The wire shall be subjected by the wire manufacturer to electric strength tests during manufacture as specified in U.3.1 and U.3.2.

U.3.1 Routine testing

The test voltage for ROUTINE TESTING shall be the appropriate test voltage in accordance with 5.2.2 of this standard, with a minimum of

- 1 500 V a.c. r.m.s. for BASIC INSULATION or SUPPLEMENTARY INSULATION, or
- 3 000 V a.c. r.m.s. for REINFORCED INSULATION.

U.3.2 Sampling tests

Twisted pair samples shall be tested in accordance with 4.4.1 of IEC 60851-5. The minimum breakdown voltage shall be twice the appropriate test voltage in accordance with 5.2.2 of this standard, with a minimum of

- 3 000 V a.c. r.m.s. for BASIC INSULATION or SUPPLEMENTARY INSULATION, or
- 6 000 V a.c. r.m.s. for REINFORCED INSULATION.

Annex V (normative)

AC power distribution systems

(see 1.6.1)

V.1 Introduction

In 3.1.2 of IEC 60364-1, a.c. power distribution systems are classified TN, TT and IT, depending on the arrangement of current-carrying conductors and the method of earthing. The classes and codes are explained in this annex. Some examples of each class are given in the figures; other configurations also exist.

In the figures:

- in most cases, the power distribution systems apply for single-phase and three-phase equipment, but for simplicity, only single-phase equipment is illustrated;
- the power sources may be transformer secondaries, motor-driven generators or uninterruptible power distribution systems;
- for transformers within a user's building, some of the figures apply, and the building boundary represents a floor of the building;
- some power distribution systems are earthed at additional points, for example, at the power entry points of users' buildings (see 413.1.3.1, Notes 1 and 2 of IEC 60364-4-41).

The following types of equipment connection are taken into account; the numbers of wires mentioned do not include conductors used exclusively for earthing.

Single-phase, two-wire

Single-phase, three-wire

Two-phase, three-wire

Three-phase, three-wire

Three-phase, four-wire

The system codes used have the following meaning:

- First letter: relationship of the power distribution system to earth;
 - T means direct connection of one pole to earth,
 - I means system isolated from earth, or one point connected to earth through an impedance.
- Second letter: earthing of the equipment;
 - T means direct electrical connection of the equipment to earth, independently of the earthing of any point of the power distribution system,
 - N means direct electrical connection of the equipment to the earthed point of the power distribution system (in a.c. systems, the earthed point of the power distribution system is normally the neutral point or, if a neutral point is not available, a phase conductor).

- Subsequent letters if any: arrangement of neutral and protective conductors;
 - S means the protective function is provided by a conductor separate from the neutral or from the earthed line (or in a.c. systems, earthed phase) conductor,
 - C means the neutral and protective functions are combined in a single conductor (PEN conductor).

V.2 TN power distribution systems

TN power distribution systems are directly earthed, the parts of the equipment required to be earthed being connected by PROTECTIVE EARTHING CONDUCTORS. Three types of TN power distribution systems are considered:

- TN-S power distribution system,
 - in which a separate protective conductor is used through-out the system;
- TN-C-S power distribution system,
 - in which neutral and protective functions are combined in a single conductor in part of the system;
- TN-C power distribution system,
 - in which neutral and protective functions are combined in a single conductor throughout the system.

Some TN power distribution systems are supplied from a secondary winding of a transformer that has an earthed centre tap (neutral). Where the two-phase conductors and the neutral conductor are available, these systems are commonly known as "single-phase, three-wire power distribution systems".

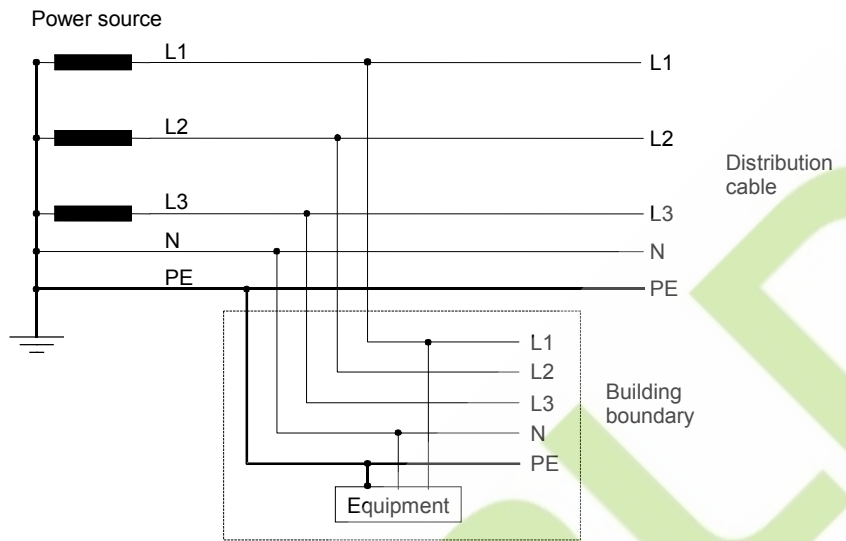

Separate neutral and protective conductors

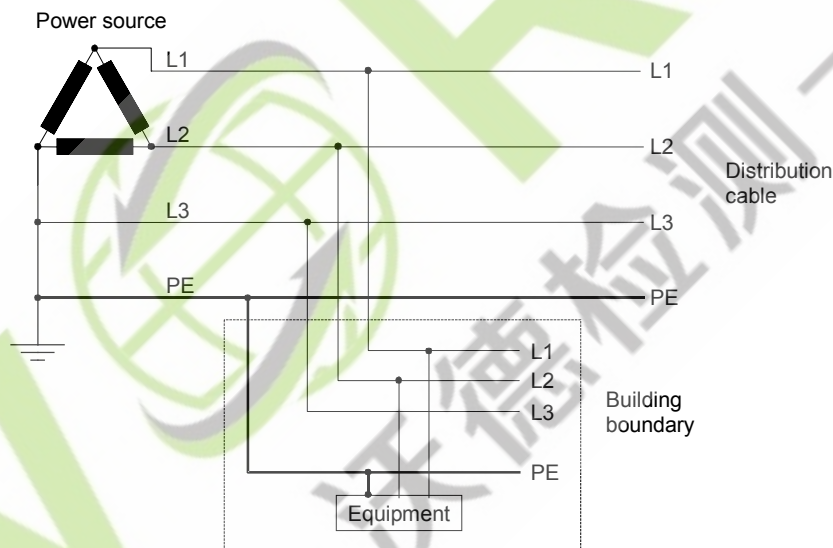

Earthed line conductor

IEC 1595/05

Figure V.1 – Examples of TN-S power distribution systems

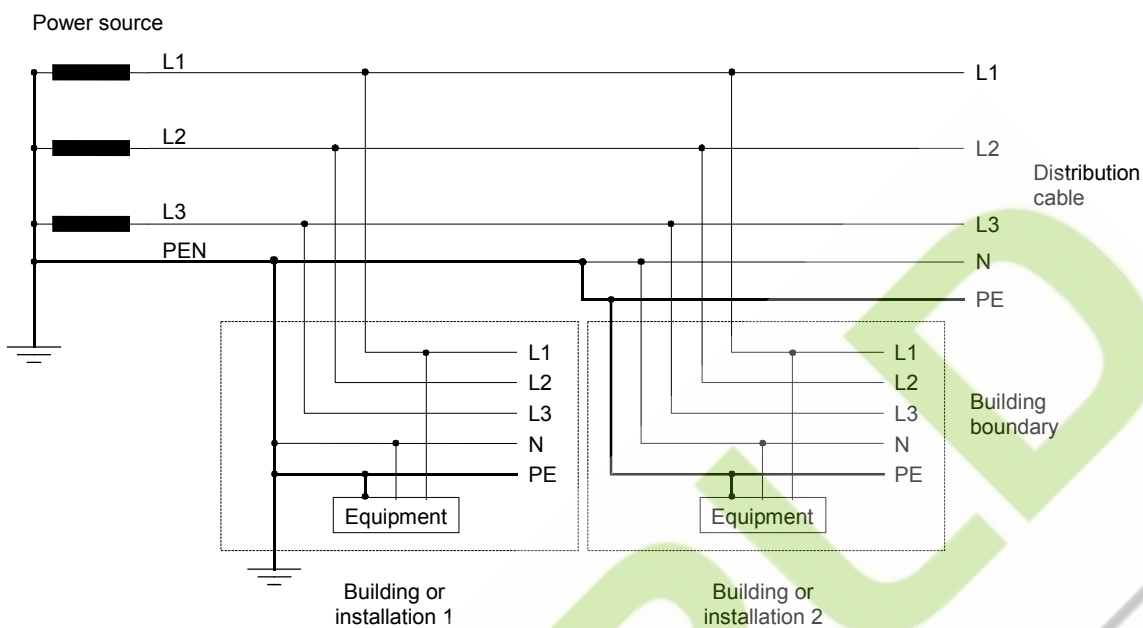

Neutral and protective functions combined in a single conductor in part of the system (PEN)

IEC 1596/05

NOTE The point at which the PEN conductor is separated into protective earth and neutral conductors may be at the building entrance or at distribution panels within the building.

Figure V.2 – Example of TN-C-S power distribution system

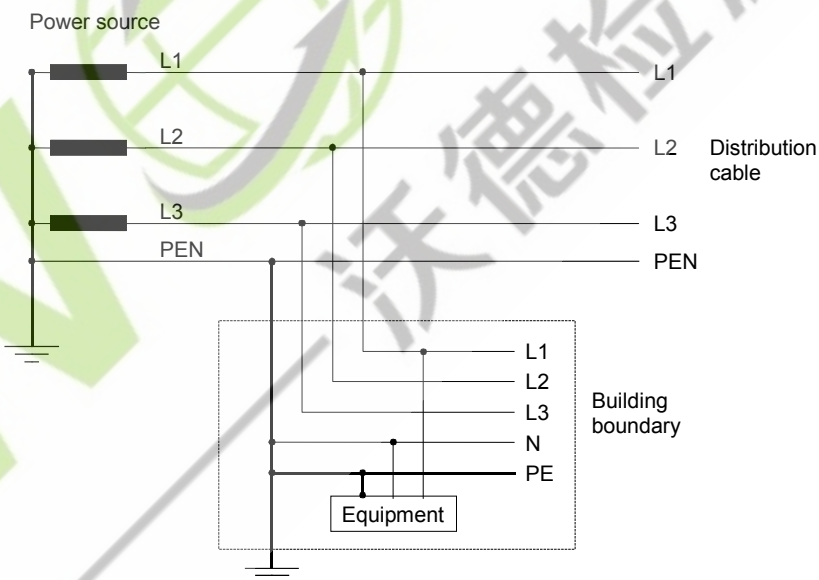

Neutral and protective functions combined in one conductor (PEN)

IEC 1597/05

Figure V.3 – Example of TN-C power distribution system

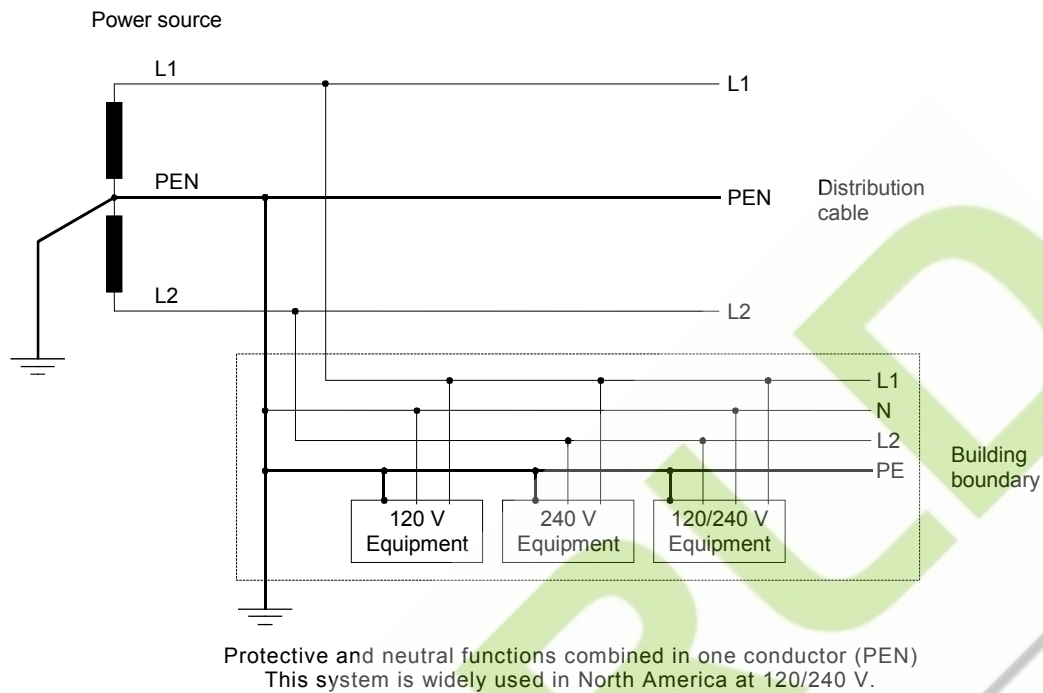

IEC 1598/05

Figure V.4 – Example of single-phase, three-wire TN-C power distribution system

V.3 TT power distribution systems

TT power distribution systems have one point directly earthed, the parts of the equipment required to be earthed being connected at the user's premises to earth electrodes that are electrically independent of the earth electrodes of the power distribution system.

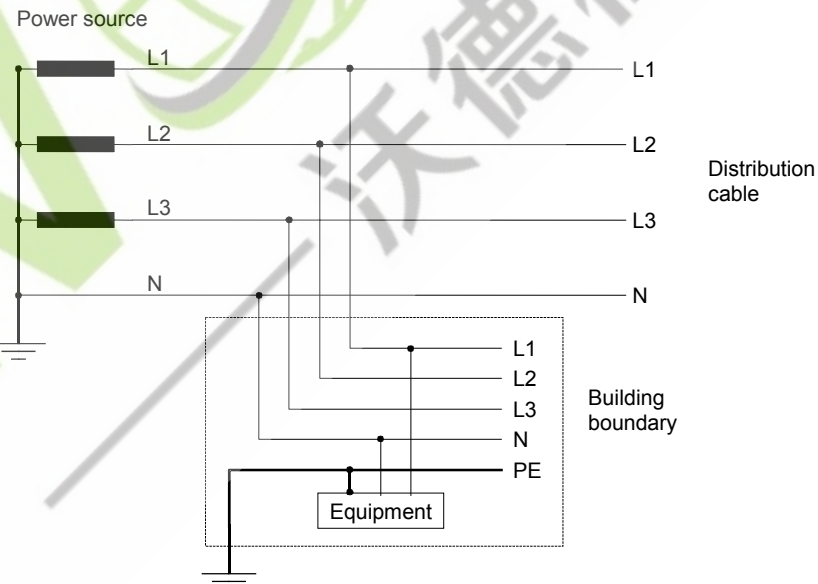

Earthed neutral and independent earthing of equipment

IEC 1599/05

Figure V.5 – Example of three line and neutral TT power distribution system

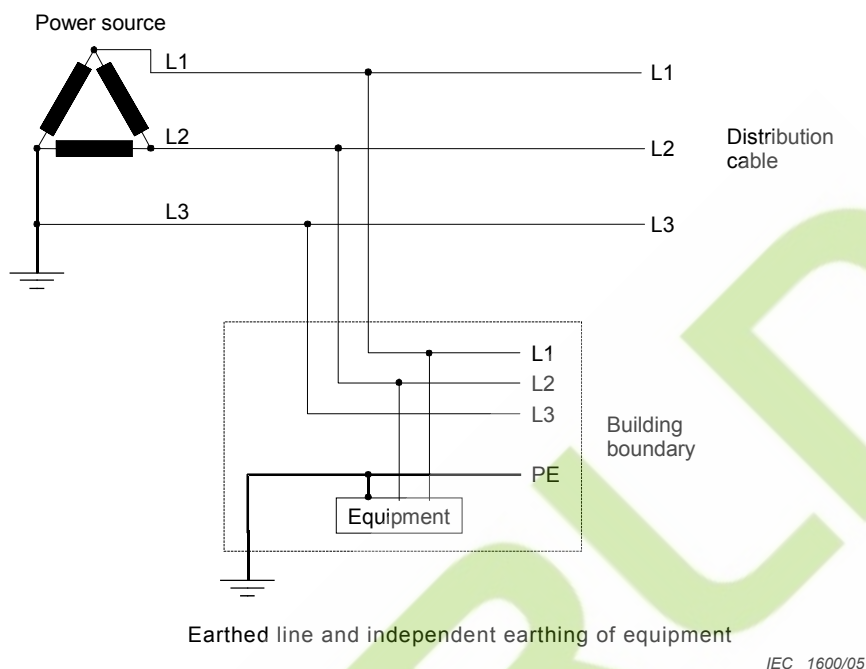
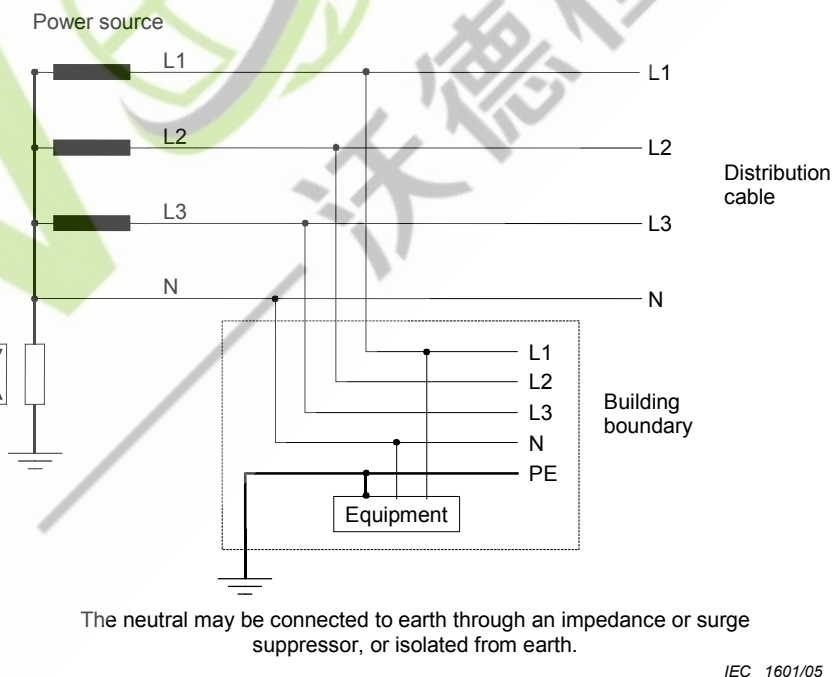

Figure V.6 – Example of three line TT power distribution system

V.4 IT power distribution systems

IT power distribution systems are isolated from earth, except that one point may be connected to earth through an impedance or a voltage limiter. The parts of the equipment required to be earthed are connected to earth electrodes at the user's premises.



This system is widely used isolated from earth, in some installations in France, with impedance to earth, at 230/400 V, and in Norway, with surge suppressor, neutral not distributed, at 230 V line-to-line.

Figure V.7 – Example of three line (and neutral) IT power distribution system

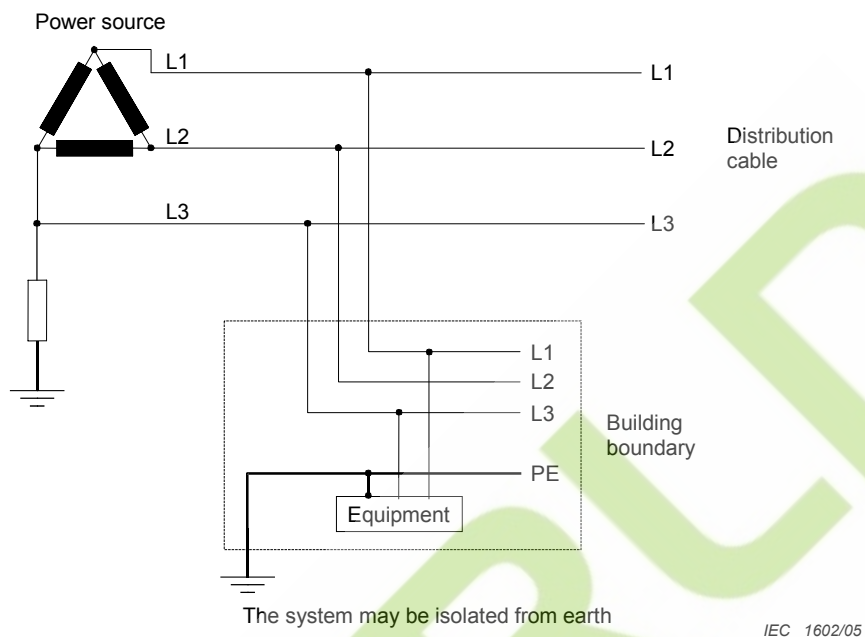

Figure V.8 – Example of three line IT power distribution system

Annex W (informative)

Summation of touch currents

This annex explains the background to the requirements and tests in 5.1.8.2.

W.1 Touch current from electronic circuits

There are two quite different mechanisms that determine the current through a human body that touches an electronic circuit (or power bus), depending on whether or not the circuit is earthed. This distinction between earthed and unearthened (floating) circuits is not the same as between CLASS I EQUIPMENT and CLASS II EQUIPMENT. Floating circuits can exist in CLASS I EQUIPMENT and earthed circuits in CLASS II EQUIPMENT. Floating circuits are commonly, but not exclusively, used in telecommunication equipment and earthed circuits in data processing equipment, also not exclusively.

In order to consider the worst case, it will be assumed in this annex that TELECOMMUNICATION NETWORKS are floating and that the AC MAINS SUPPLY and human bodies (SERVICE PERSONS or USERS) are earthed. It should be noted that a SERVICE PERSON can touch some parts that are not USER-accessible. An "earthed" circuit means that the circuit is either directly earthed or in some way referenced to earth so that its potential with respect to earth is fixed.

W.1.1 Floating circuits

If the circuit is not earthed, the current (I_C) through the human body is "leakage" through stray or added capacitance (C) across the insulation in the mains transformer (see Figure W.1).

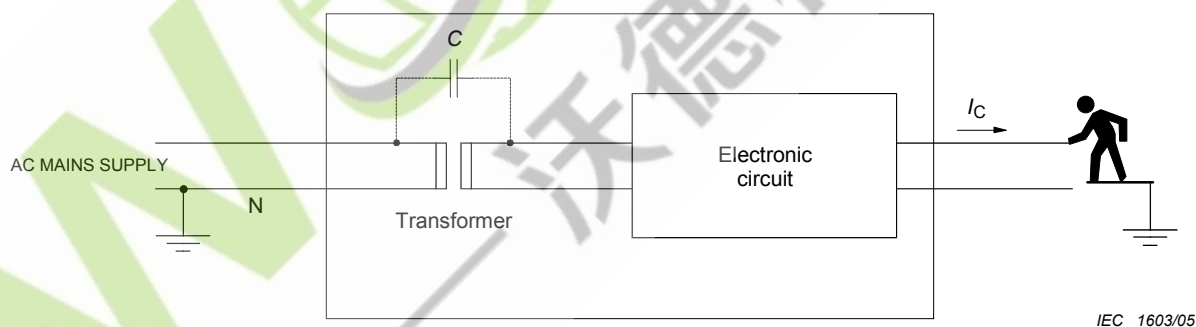

Figure W.1 – Touch current from a floating circuit

This current comes from a relatively high voltage, high impedance source, and its value is largely unaffected by the operating voltage on the electronic circuit. In this standard, the body current (I_C) is limited by applying a test using the measuring instrument in Annex D, which roughly simulates a human body.

W.1.2 Earthed circuits

If the electronic circuit is earthed, the current through the human body (I_V) is due to the operating voltage (V) of the circuit, which is a source of low impedance compared with the body (see Figure W.2). Any leakage current from the mains transformer (see W.1.1), will be conducted to earth and will not pass through the body.

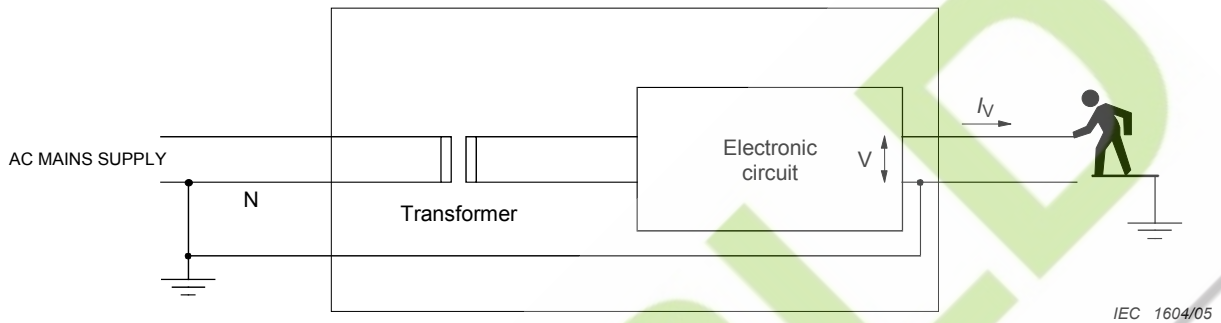

Figure W.2 – Touch current from an earthed circuit

In this standard, the body current (I_V) is limited by specifying maximum voltage values for the accessible circuit, which shall be an SELV CIRCUIT or (with restricted accessibility) a TNV CIRCUIT.

W.2 Interconnection of several equipments

It is a characteristic of information technology equipment, in particular in telecommunication applications, that many equipments may be connected to a single central equipment in a "star" topology. An example is telephone extensions or data terminals connected to a PABX, which may have tens or hundreds of ports. This example is used in the following description (see Figure W.3).

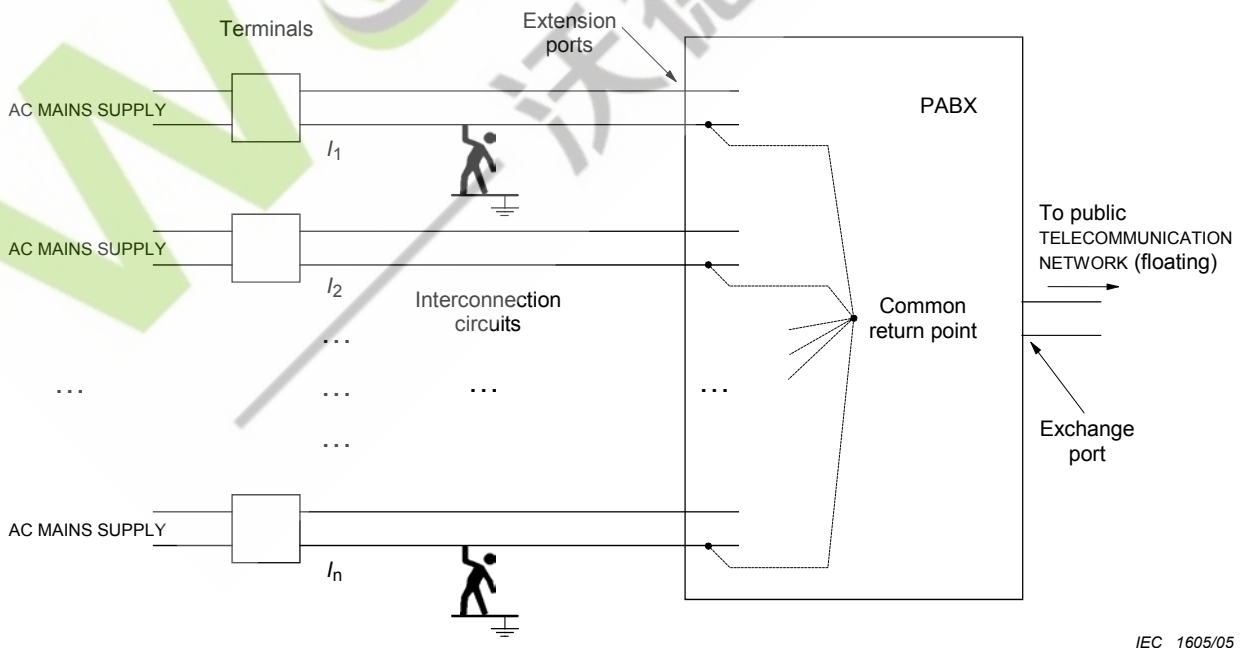

Figure W.3 – Summation of touch currents in a PABX

Each terminal equipment can deliver current to a human body touching the interconnecting circuit (I_1 , I_2 , etc.), added to any current coming from the PABX port circuitry. If several circuits are connected to a common point, their individual TOUCH CURRENTS will add together, and this represents a possible risk to an earthed human body that touches the interconnection circuit.

Various ways of avoiding this risk are considered in the following subclauses.

W.2.1 Isolation

Isolate all interconnection circuits from each other and from earth, and limit I_1 , I_2 , etc., as described in W.1.1. This implies either the use in the PABX of a separate power supply for each port, or the provision of an individual line (signal) transformer for each port. Such solutions may not be cost effective.

W.2.2 Common return, isolated from earth

Connect all interconnection circuits to a common return point that is isolated from earth. (Such connections to a common point may in any case be necessary for functional reasons.) In this case the total current from all interconnection circuits will pass through an earthed human body that touches either wire of any interconnection circuit. This current can only be limited by controlling the values I_1 , I_2 ,... I_n in relation to the number of ports on the PABX. However, the value of the total current will probably be less than $I_1 + I_2 + \dots + I_n$ due to harmonic and other effects.

W.2.3 Common return, connected to protective earth

Connect all interconnection circuits to a common return point and connect that point to protective earth. The situation described in W.1.2 applies regardless of the number of ports. Since safety depends on the presence of the earth connection, it may be necessary to use high-integrity earthing arrangements, depending on the maximum value of the total current that could flow.

Annex X (informative)

Maximum heating effect in transformer tests

(see Clause C.1)

Clause C.1 requires transformers to be loaded in such a way as to give the maximum heating effect. In this annex examples are given of various methods of producing this condition. Other methods are possible and compliance with Clause C.1 is not restricted to these examples.

X.1 Determination of maximum input current

The value of the input current at rated load is established. This is I_r , see step A of Table X.1. The value may be established by test or from manufacturer's data.

A load is applied to the output winding or to the output of the switch mode power supply unit while measuring the input current. The load is adjusted as quickly as possible to provide the maximum value of input current that can be sustained for approximately 10 s of operation. This is I_m , see step B of Table X.1. The test is then repeated according to step C and, if necessary, steps D to J of Table X.1. The input current at each step is then noted and maintained until either:

- a) the temperature of the transformer stabilizes without the operation of any component or protective device (inherent protection) in which case no further testing is conducted; or*
- b) component or protective device operates, in which case the winding temperature is noted immediately and the test of Clause X.2 is then conducted depending on the type of protection.*

If any component or protective device operates within 10 s after the application of the primary voltage, I_m is the value recorded just before the component or protective device operates.

In conducting the tests described in steps C to J of Table X.1, the variable load is adjusted to the required value as quickly as possible and readjusted, if necessary, 1 min after application of the primary voltage. The sequence of steps C to J may be reversed.

Table X.1 – Test steps

| Steps | Input current of the transformer or switch mode power supply unit |
|-------|---|
| A | Input current at rated load = I_r |
| B | Maximum value of input current after 10 s of operation = I_m |
| C | $I_r + 0,75 (I_m - I_r)$ |
| D | $I_r + 0,50 (I_m - I_r)$ |
| E | $I_r + 0,25 (I_m - I_r)$ |
| F | $I_r + 0,20 (I_m - I_r)$ |
| G | $I_r + 0,15 (I_m - I_r)$ |
| H | $I_r + 0,10 (I_m - I_r)$ |
| J | $I_r + 0,05 (I_m - I_r)$ |

X.2 Overload test procedure

If the test of Clause X.1 results in condition X.1 b), the following applies depending on type of protection.

Electronic protection:

The current is either reduced in steps of 5 % from the current of condition X.1 b) or increased in steps of 5 % from the rated load to find the maximum overload at which the temperature stabilizes without the operation of any electronic protection.

Thermal protection:

An overload is applied such that the operating temperature remains a few degrees below the rated opening temperature of the thermal protection.

Overcurrent protection:

An overload is applied such that a current flows in accordance with the current versus time trip curves of the overcurrent protective device.

Annex Y (normative)

Ultraviolet light conditioning test

(see 4.3.13.3)

Y.1 Test apparatus

Samples are exposed to ultraviolet light by using one of the following apparatus:

- *a twin enclosed carbon-arc, (see Clause Y.3), with continuous exposure. The test apparatus shall operate with a black-panel temperature of $63\text{ °C} \pm 3\text{ °C}$ in a relative humidity of $50\% \pm 5\%$; or*
- *a xenon-arc (see Clause Y.4), with continuous exposure. The test apparatus shall operate with a 6 500 W, water-cooled xenon-arc lamp, a spectral irradiance of $0,35\text{ W/m}^2$ at 340 nm, a black-panel temperature of $63\text{ °C} \pm 3\text{ °C}$ in a relative humidity of $50\% \pm 5\%$.*

Y.2 Mounting of test samples

The samples are mounted vertically on the inside of the cylinder of the light exposure apparatus, with the widest portion of the samples facing the arcs. They are mounted so that they do not touch each other.

Y.3 Carbon-arc light-exposure apparatus

The apparatus described in ISO 4892-4, or equivalent, is used in accordance with the procedures given in ISO 4892-1 and ISO 4892-4 using a type 1 filter, without water spray.

Y.4 Xenon-arc light-exposure apparatus

The apparatus described in ISO 4892-2, or equivalent, is used in accordance with the procedures given in ISO 4892-1 and ISO 4892-2 using method A, without water spray.

NOTE The wording "without water spray" indicates that the samples are not sprayed with water during the test. This should not be confused with water cooling which is necessary for operation of the apparatus.

Annex Z
(informative)

Overvoltage categories

(see 2.10.3.2 and Clause G.2)

The largest peak value of transient overvoltage likely to be experienced at the power input interface of equipment connected to a MAINS SUPPLY is known as the MAINS TRANSIENT VOLTAGE. In this standard, minimum CLEARANCES for insulation in PRIMARY CIRCUITS are based on the MAINS TRANSIENT VOLTAGE.

According to IEC 60664-1, the value of the MAINS TRANSIENT VOLTAGE of an AC MAINS SUPPLY depends on the AC MAINS SUPPLY voltage and the Overvoltage Category, I to IV, see also Table G.1.

The Overvoltage Category therefore has to be identified for each equipment intended to be connected to the AC MAINS SUPPLY.

The Overvoltage Category depends on the manner of connection of the equipment to the building power supply arrangements. It is normally considered to be as shown in Table Z.1. Where transient limiting measures are provided, such as external filters in the AC MAINS SUPPLY, the equipment can be used in a higher Overvoltage Category.

The term Overvoltage Category is not used in connection with DC MAINS SUPPLIES.

Table Z.1 – Overvoltage categories

| Overvoltage Category | Equipment and its point of connection to the AC MAINS SUPPLY | Examples of equipment |
|----------------------|--|--|
| IV | Equipment that will be connected to the point where the AC MAINS SUPPLY enters the building | Electricity meters Communications information technology equipment for remote electricity metering |
| III | Equipment that will be an integral part of the building wiring | Socket-outlets, fuse panels and switch panels Power monitoring equipment |
| II | PLUGGABLE or PERMANENTLY CONNECTED EQUIPMENT that will be supplied from the building wiring | Household appliances, portable tools, home electronics Most information technology equipment used in the building |
| I | Equipment that will be connected to a special AC MAINS SUPPLY in which measures have been taken to reduce transients | Information technology equipment supplied via an external filter or a motor driven generator |

Annex AA
(normative)

Mandrel test
(see 2.10.5.8)

NOTE This test is based on IEC 61558-1 and will give the same results.

Three test samples, each individual sample consisting of three or more layers of non-separable thin sheet material forming REINFORCED INSULATION, are used. One sample at a time is fixed to the mandrel of the test fixture (Figure AA.1) as shown in Figure AA.2.

Dimensions in millimeters

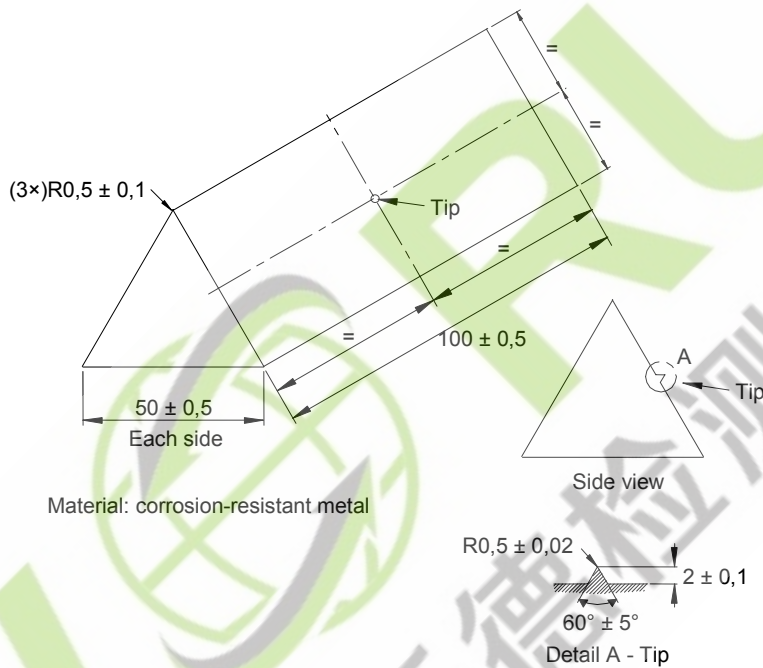
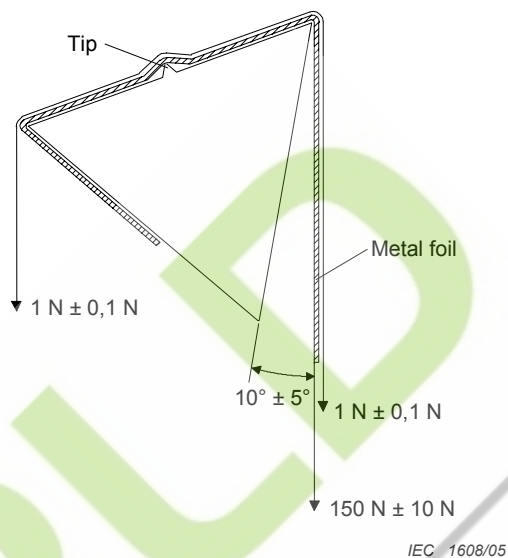
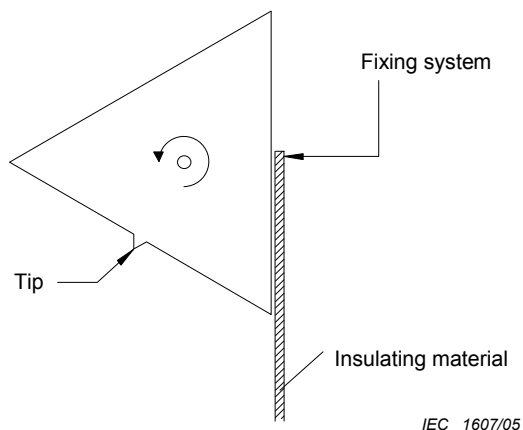

Figure AA.1 – Mandrel



The final position of the mandrel is rotated $230^\circ \pm 5^\circ$ from the initial position

Figure AA.2 – Initial position of mandrel

Figure AA.3 – Final position of mandrel

A downward force of $150\text{ N} \pm 10\text{ N}$ is applied to the free end of the sample (see Figure AA.3), using an appropriate clamping device. The mandrel is rotated

- from the initial position (Figure AA.2) to the final position (Figure AA.3) and back;
- as above for a second time;
- from the initial position to the final position.

If a sample breaks during rotation where it is fixed to the mandrel or to the clamping device, this does not constitute a failure. If a sample breaks at any other place, the test has failed.

After the above test, a sheet of metal foil, $0,035\text{ mm} \pm 0,005\text{ mm}$ thick, at least 200 mm long, is placed along the surface of the sample, hanging down on each side of the mandrel (see Figure AA.3). The surface of the foil in contact with the sample shall be conductive, not oxidized or otherwise insulated. The foil is positioned so that its edges are not less than 18 mm from the edges of the sample (see Figure AA.4). The foil is then tightened by two equal weights, one at each end, using appropriate clamping devices.

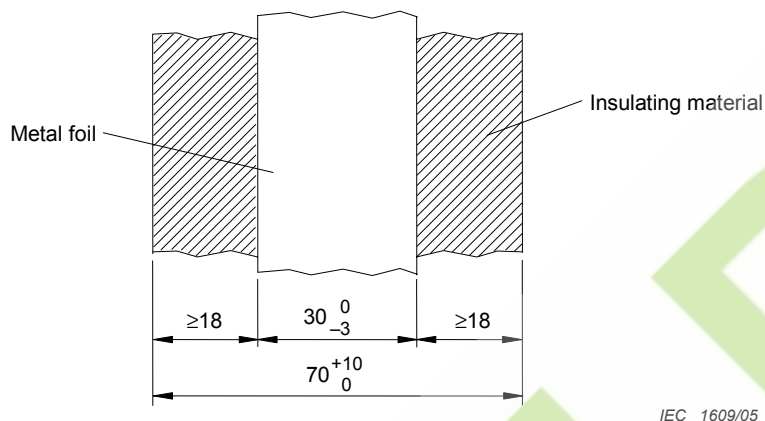

Figure AA.4 – Position of metal foil on insulating material

While the mandrel is in its final position, and within the 60 s following the final positioning, an electric strength test is applied between the mandrel and the metal foil in accordance with 5.2.2. The test voltage is 150 % of U_{test} , but not less than 5 kV. U_{test} is the test voltage specified in 5.2.2 for SUPPLEMENTARY INSULATION or REINFORCED INSULATION as appropriate.

The entire test procedure is repeated on the other two samples.

Annex BB
(informative)

Changes in the second edition

BB.1 Numbering changes table

The following subclause, annex, figure and table numbers have changed since the first edition of IEC 60950-1.

| First Edition | Action | This edition |
|------------------|------------------------|------------------|
| 1.2.2.3 | deleted | |
| | new | 1.2.2.3 |
| 1.2.2.4 | deleted | |
| 1.2.2.5 | deleted | |
| | new | 1.2.5.3 |
| 1.2.5.3 to 5 | renumbered | 1.2.5.4 to 6 |
| | new | 1.2.8.3 |
| 1.2.8.3 to 13 | renumbered | 1.2.8.4 to 14 |
| | new | 1.2.9.7 |
| 1.2.9.7 to 10 | renumbered | 1.2.9.8 to 11 |
| | new | 1.2.10.4 |
| | new | 1.2.13.15 |
| | new | 1.2.13.16 |
| | new | 1.2.13.17 |
| 1.5.6, 1.5.7.2 | replaced | 1.5.6 |
| 1.5.7 | replaced | 1.5.7 |
| | new | 1.5.9 |
| | new | 1.7.2.1 to 3 |
| 1.7.10 | renumbered | 1.7.2.4 |
| 1.7.11 | renumbered | 1.7.10 |
| 1.7.12 | deleted | |
| 1.7.13 to 15 | renumbered | 1.7.11 to 13 |
| 1.7.16 | renumbered | 1.7.2.5 |
| 1.7.17 | renumbered | 1.7.14 |
| | new | 1.7.2.6 |
| | new | 2.1.1.8 |
| | new | 2.1.1.9 |
| 2.2.3.1 | deleted | |
| 2.2.3.2 | deleted | |
| 2.2.3.3 | deleted | |
| | new | 2.3.2.1 to 4 |
| 2.6.1 c) | combined with 2.6.1 b) | |
| 2.6.1 d) to g) | renumbered | 2.6.1 c) to f) |
| | new | 2.9.4 |
| 2.10 | replaced | 2.10 |
| | new | 3.5.4 |
| | new | 4.5.1 |
| 4.5.1 | renumbered | 4.5.2 |
| 4.5.2 | renumbered | 4.5.5 |
| | new | 4.5.3 |
| | new | 4.5.4 |
| | new | 4.6.4.1 to 3 |
| | new | 5.1.2.1 to 3 |
| | new | 5.1.7.1 to 2 |
| | new | 5.3.6 |
| 5.3.6 to 5.3.8.2 | renumbered | 5.3.7 to 5.3.9.2 |
| | new | 7.1 |
| 7.1 to 7.2 | renumbered | 7.2 to 7.3 |

| First Edition | Action | This edition |
|------------------------|----------------------|------------------------|
| 7.3.1 to 7.3.3 | renumbered | 7.4.1 to 7.4.3 |
| | new | B.6.1 to 4 |
| | new | B.7.1 |
| B.7.1 to B.7.3 | renumbered | B.7.2 to B.7.4 |
| | new | G.1.1 |
| G.1 | renumbered | G.1.2 |
| | new | G.2.3 |
| | new | G.2.4 |
| G.4 a) | renumbered | G.4.1 |
| G.4 b) | renumbered | G.4.2 |
| G.4 c) | renumbered | G.4.3 |
| G.4 d) | renumbered | G.4.4 |
| | new | Annex Q |
| Annex Q | renamed | Bibliography |
| | new | Annex Z |
| | new | Annex AA |
| | new | Annex BB |
| | new | Figure 2D |
| | new | Figure 2E |
| Figure 2D to Figure 2H | renumbered | Figure 2F to Figure 2K |
| Figure F.12 | split and renumbered | Figures 2D and F.12 |
| | new | Figure F.14 to F.18 |
| | new | Figure AA.1 to AA.4 |
| | new | Table 1B |
| | new | Table 1C |
| | new | Table 1D |
| | new | Table 2E |
| Table 2E to Table 2G | renumbered | Table 2F to Table 2H |
| | new | Table 2J |
| Table 2H to Table 2L | renumbered | Table 2K to Table 2N |
| | new | Table 2P |
| Table 2M | renumbered | Table 2R |
| Table 2N | renumbered | Table 2Q |
| Table 4B part 1 | renumbered | Table 4B |
| Table 4B part 2 | renumbered | Table 4C |
| Table 4C | renumbered | Table 4D |
| Table 4D | renumbered | Table 4E |
| | new | Table 5C |
| | new | Table 5D |
| | new | Table Z.1 |

Changes to this edition

The principal changes in this edition as compared with the first edition of IEC 60950-1 are as follows. Minor changes are not listed.

Audio amplifiers, requirements added for consistency with IEC 60065 (2.1.1.9, 4.5.1).

Ball pressure test, test procedure corrected, different at high ambients (4.5.5).

Batteries, requirements enhanced (4.3.8).

Bibliography moved to a new section after the Annexes

CABLE DISTRIBUTION SYSTEMS, voltage tests clarified (7.4.2, 7.4.3).

Cathode ray tubes, requirements aligned with IEC 60065 (4.2.8).

Connectors, lower minimum CLEARANCES and CREEPAGE DISTANCES (2.10.3.1, 2.10.4.3, G.6).

Data ports for additional equipment, requirements added to limit power output (3.5.4)

Definitions added:

- CHEESECLOTH (1.2.13.15);
- EQUIPMENT, PLUGGABLE (1.2.5.3);
- INSULATION, SOLID (1.2.10.4);
- RATING, PROTECTIVE CURRENT (1.2.13.17);
- SUPPLY, MAINS (1.2.8.3);
- TIME, RATED RESTING (1.2.2.3);
- TISSUE, WRAPPING (1.2.13.16);
- VOLTAGE, RMS WORKING (1.2.9.7).

DC MAINS SUPPLIES, more detailed requirements regarding:

- CLEARANCES [2.10.3.2 b) and c), 2.10.3.7, 2.10.3.9, G.2.2, G.2.3, G.4.1 c), G.5 a)];
- shock hazard (2.1.1.7, 2.1.1.8).

Distance through insulation, requirements clarified (2.10.5) in particular:

- optocouplers, aligned with IEC 60747 (2.10.5.4, Figure F.17);
- non-separable thin sheet material (2.10.5.8).

"Hiccup" mode of power supplies (2.2.3).

Insulation having starting pulses, requirements added (2.10.1.7, 2.10.2.1, 2.10.3.5).

Insulation in non-separable thin sheets, aligned with IEC 61558-1 (2.10.5.8, 2.10.5.9, Annex AA).

Insulation in wound components, requirements clarified (2.10.5.11, 2.10.5.14, Annex U) including:

- winding wire (2.10.5.12);
- solvent-based enamel on winding wire (2.10.5.1, 2.10.5.13).

Language for marking, requirement for local language removed (1.7.2.1 Note 3).

Limited power sources, tests clarified (2.5).

Mechanical strength, tests clarified (4.2.5, 4.2.6).

Motor test, alternative procedure added (B.6.3).

Non-continuous operation, requirements clarified (1.2.2, 1.7.3, 4.5.2, 5.3.8).

Overcurrent protective devices to be specified if required externally (1.7.2.3).

Overvoltage categories III and IV, requirements added or clarified (2.10.3.1, 5.2.2, G.1.1, Annex Z).

Pollution degrees 2 and 3, CLEARANCES modified to align with IEC 60664-1 (Table G.2).

PROTECTIVE BONDING CONDUCTORS, requirements and test procedure modified (2.6.3.3, 2.6.3.4).

Resistors, bridging insulation (1.5.7).

Ring signals, test procedure for "Part 68" corrected and clarified (M.3).

Scope clarified, this standard can be used for:

- partial compliance of component subassemblies (1.1.1);
- electronic parts of certain other equipment (1.1.1 Note 2).

SELV CIRCUIT and TNV CIRCUIT requirements for separation aligned (2.3.2, 2.3.3, 2.9.4).

Single-pole isolators, rules clarified (3.4.6).

Starting pulses, requirements added (2.10.1.7, 2.10.2.1, 2.10.3.5).

Surge suppressors:

- VDRs in PRIMARY CIRCUITS, requirements clarified (1.5.9);
- more detail to determine minimum rated operating voltage (6.1.2.1).

Thermal classes of insulation, classes 200, 220 and 250 added in line with IEC 60085 (Tables 5D, B.1, B.2, C.1, U.2).

TRANSPORTABLE EQUIPMENT, requirements for openings in ENCLOSURES (4.6.4).

TOUCH CURRENT:

- test procedure clarified for equipment with multiple supply connections (5.1.2, 5.1.7.2);
- requirements extended for PLUGGABLE EQUIPMENT TYPE A (5.1.7.1).

Wall-mounted equipment, test procedure modified (4.2.10).

X and Y capacitors bridging insulation, applications clarified, aligned with IEC 60384-14 (1.5.6).



沃德检测

Bibliography

This Bibliography contains information about documents referred to in notes and informative annexes in the standard. Further information on the listed documents, including how to obtain copies, can be found on the following internet sites:

<http://www.bsonline.techindex.co.uk>
<http://www.cas.org>
<http://www.cenelec.org>
<http://www.cie.co.at>
<http://www.icrp.org> and (to obtain copies: <http://www.elsevier.nl/locate/icrp>)
<http://www.iec.ch>
<http://www.iso.org>
<http://www.itu.int>
<http://www.standards.com.au>
<http://wireless.fcc.gov/rules.htm> (for CFR 47 Part 68)

For the locations in the standard where these documents are mentioned, see the Index.

IEC 60050-212:1990, *International Electrotechnical Vocabulary – Chapter 212: Insulating solids, liquids and gases*

IEC 60127 (all parts), *Miniature fuses*

NOTE Harmonized in EN 60127 series (not modified).

IEC 60269-2-1, *Low voltage fuses – Part 2-1: Supplementary requirements for fuses for use by authorized persons (fuses mainly for industrial application) – Sections I to VI: Examples of types of standardized fuses*

NOTE Harmonized as HD 60369-2-1:2005 (modified).

IEC 60364-4-41, *Electrical installations of buildings – Part 4-41: Protection for safety – Protection against electric shock*

NOTE Harmonized as HD 384.4.41 S2:1996 (modified).

IEC 60410, *Sampling plans and procedures for inspection by attributes*

IEC 60529, *Degrees of protection provided by enclosures (IP Code)*

NOTE Harmonized as EN 60529:1991 (not modified).

IEC 60664-4, *Insulation coordination for equipment within low voltage systems – Part 4: Considerations of high-frequency voltage stress*

NOTE Harmonized as EN 60664-4:2006 (not modified).

IEC 60728-11:2005, *Cable networks for television signals, sound signals and interactive services – Part 11: Safety*

NOTE Harmonized as EN 60728-11:2005 (modified).

IEC 60896-21, *Stationary lead-acid batteries – Part 21: Valve regulated types - Methods of test*

NOTE Harmonized as EN 60896-21:2004 (not modified).

IEC 60896-22, *Stationary lead-acid batteries – Part 22: Valve regulated types – Requirements*

NOTE Harmonized as EN 60896-22:2004 (not modified).

IEC 61032:1997, *Protection of persons and equipment by enclosures – Probes for verification*

☐ NOTE Harmonized as EN 61032:1998 (not modified). ☐

IEC 61140, *Protection against electric shock – Common aspects for installation and equipment*

☐ NOTE Harmonized as EN 61140:2002 (not modified). ☐

IEC 61558-1, *Safety of power transformers, power supply units and similar - Part 1: General requirements and tests*

☐ NOTE Harmonized as EN 61558-1:2005 (not modified). ☐

IEC 61643-21, *Low voltage surge protective devices – Part 21: Surge protective devices connected to telecommunications and signalling networks – Performance requirements and testing methods*

☐ NOTE Harmonized as EN 61643-21:2001 (not modified). ☐

IEC 61643-311, *Components for low-voltage surge protective devices – Part 311: Specifications for gas discharge tubes (GDT)*

☐ NOTE Harmonized as EN 61643-311:2001 (not modified). ☐

IEC 61643-321, *Components for low-voltage surge protective devices – Part 321: Specifications for avalanche breakdown diode (ABD)*

☐ NOTE Harmonized as EN 61643-321:2002 (not modified). ☐

IEC 61643-331, *Components for low-voltage surge protective devices – Part 331: Specifications for metal oxide varistors (MOV)*

☐ NOTE Harmonized as EN 61643-331:2003 (not modified). ☐

IEC 61965, *Mechanical safety of cathode ray tubes*

☐ NOTE Harmonized as EN 61965:2003 (not modified). ☐

IEC Guide 112, *Guide on the safety of multimedia equipment*

ISO 2859-1, *Sampling procedures for inspection by attributes – Part 1: Sampling schemes indexed by acceptance quality limit (AQL) for lot-by-lot inspection*

ISO 4046-4, *Paper, board, pulp and related terms – Vocabulary – Part 4: Paper and board grades and converted products*

ISO 4892 (all parts), *Plastics – Methods of exposure to laboratory light sources*

☐ NOTE Harmonized in EN ISO 4892 series (not modified). ☐

ITU-T Recommendation K.11 *Principles of protection against overvoltages and overcurrents*

ITU-T Recommendation K.20, *Resistibility of telecommunication equipment installed in a telecommunications centre to overvoltages and overcurrents*

ITU-T Recommendation K.21 *Resistibility of telecommunication equipment installed in customer premises to overvoltages and overcurrents*

ITU-T Recommendation K.27 *Bonding configurations and earthing inside a telecommunication building*

ITU-T Recommendation K.45 *Resistibility of telecommunication equipment installed in the access and trunk networks to overvoltages and overcurrents*

AS/NZS 3112, *Approval and test specification - Plugs and socket-outlets*

BS 1363 (all parts), *13 A plugs, socket-outlets and adaptors*

CAS#110-54-3, American Chemical Society definition

CFR 47, Part 68: *Code of Federal Regulations (USA) Part 68: Connection of terminal equipment to the telephone network (commonly referred to as "FCC Rules, part 68")*

CIE Publication 63, *The spectroradiometric measurement of light sources*

EN 50272-2, *Safety requirements for secondary batteries and battery installations - Part 2: Stationary batteries*

☐ EN 50332-1:2000, *Sound system equipment: Headphones and earphones associated with portable audio equipment - Maximum sound pressure level measurement methodology and limit considerations - Part 1: General method for "one package equipment"*

EN 50332-2:2003, *Sound system equipment: Headphones and earphones associated with portable audio equipment - Maximum sound pressure level measurement methodology and limit considerations - Part 2: Matching of sets with headphones if either or both are offered separately* ☐

EN 60950-1, *Information technology equipment - Safety - Part 1: General requirements*

ICRP 60, *Recommendations of the International Commission on Radiological Protection*

INDEX

This index is for information only and does not purport to be a complete guide to the use of this standard. The inclusion or omission of items in the index does not imply any particular importance.

Location references are clause or subclause numbers or annex letters.

In the standard, table numbers and figure numbers are linked to the clause or annex in which they are found, for example:

- Table 2A is the first Table in Clause 2;
- Figure F.2 is the second Figure in Annex F.

Principal references are printed in **bold** type.

If a term is defined in 1.2 of this standard, its definition is indicated in the index by an asterisk, for example:

- RATED VOLTAGE 1.2.1.1*.

This index is also used to explain some abbreviations, for example:

- EUT EQUIPMENT UNDER TEST.

Country notes are listed, but the contents of country notes are not indexed.

Bib is an abbreviation for Bibliography, which precedes this Index.

| | | | |
|-----------------------------------|---|---|---|
| A | | | |
| abnormal conditions | 0.1, 1.3.2 | adjustable capacitor | 4.3.3 |
| audio amplifiers | 5.3.6 | connections | 1.5.6, 2.1.1.7 |
| heat | 4.5.5 | equivalent source | 3.2.1.1 , 3.2.5.1, 3.4.2, 5.1.2.1, 5.1.2.2, 5.1.2.3 |
| overload protection | 5.3.1, 5.3.3 | for a limited power source | 1.2.8.1, 1.4.5 |
| sequence of testing | 1.4.3 | for a telecommunications medium | 2.5 |
| simulated | | | 1.1.1, Clause 6 (note 4), Clause 7.1 (note 4) |
| fan not running | 4.3.12 | frequency | 1.4.7 |
| general | 4.7.1 | isolation | <i>see</i> disconnection |
| one at a time | 1.4.14 | neutral | 3.4.6, 3.4.7 |
| test under abnormal conditions of | | terminals | 1.7.7.2, 3.3.7 |
| electrical components | 5.3.7 | | <i>see also</i> mains, OVERVOLTAGE CATEGORY, POWER SUPPLY CORD, PRIMARY CIRCUIT, transients <i>and</i> WIRING TERMINALS |
| electromechanical components | 5.3.5 | a.c. and d.c. waveform, resultant voltage | 2.10.2.2 (note) |
| materials | 4.7.3 | a.c. power distribution system | <i>see</i> power distribution system, a.c. |
| thermoplastic parts | 4.5.5 | access, accessibility | |
| motors | 5.3.2, Annex B | by | |
| thermostats | K.6 | a SERVICE PERSON | <i>see</i> SERVICE ACCESS AREA |
| THERMAL CUT-OUT operates | 1.2.11.3 | a USER or OPERATOR | <i>see</i> OPERATOR ACCESS AREA |
| transformers | 5.3.3, C.1, Annex X | <i>see also</i> | RESTRICTED ACCESS LOCATION |
| within FIRE ENCLOSURE | 4.7.3.2 | definitions | 1.2.7* |
| abnormal operating conditions | <i>see</i> abnormal conditions | | |
| abrasion resistance test | 2.10.7, 2.10.8.4 , Annex R (Table R.1) | | |
| AC MAINS SUPPLY | 1.2.8.1*, 1.7.1 | | |

| | | | |
|--|--|---|---|
| into a battery compartment | 2.1.1.2 | as disconnect device | see disconnection for servicing |
| meaning in OPERATOR access (area) | 1.2.7.1 | as means of connection to earth | 2.6.5.4 |
| prevention by a SAFETY INTERLOCK | 2.1.1.1 | fault testing | 5.3.7 |
| through an opening in an ENCLOSURE | 2.1.1.1 and Figure 2D | in PLUGGABLE EQUIPMENT | 1.2.5.1, 1.2.5.2 |
| to | | ON DETACHABLE POWER SUPPLY CORD | 1.2.5.5, 3.2.5.1 (note 1) |
| CABLE DISTRIBUTION NETWORK | 7.2, 7.3 | reversible (unpolarized) | 3.4.6 (note), 4.3.7 |
| connector shell | 2.1.1.1 | that fills an aperture in an ENCLOSURE | 4.7.3.2 |
| connectors, by a SERVICE PERSON | 4.3.5 | appliance inlet | 3.2.4 |
| controls | 4.3.3 | as means of connection to power | 3.2.1.1, 3.2.1.2 |
| disconnect device | 1.7.2.2 | earthing terminal | 2.6.4.2, 2.6.4.3 |
| ELV CIRCUIT | see ELV CIRCUIT, accessibility | see also appliance coupler | |
| energized part | 0.1, 2.1.1 | applicability | |
| fuses | 1.7.6 | of requirements | 1.3.1 |
| handles, levers, knobs | 2.1.1.6 | of tests | 1.4 , 1.5.2 |
| internal wiring | 2.1.1.3, 2.1.1.4 | of this standard | 1.1.1 |
| laser radiation | see laser radiation | to components and subassemblies | 1.1.1 (note 1) |
| plugs and sockets, by a SERVICE PERSON | 4.3.5 | to electronic parts of equipment | 1.1.1 (and note 2) |
| SAFETY INTERLOCK, moving part | 2.8.2, 4.4 | arcing | |
| sharp edge | 4.3.1 | as energy hazard | 0.2.2 |
| standard outlets | 1.7.5 | causing ignition of air filter | 4.7.3.5 |
| TELECOMMUNICATION NETWORK | 6.2.1 | in DC SUPPLY | 3.4.2 |
| terminals in supply wiring space | 3.2.9 | in FIRE ENCLOSURE | 4.7.2.1, 4.7.3.2 |
| TNV CIRCUIT | see TNV CIRCUIT, accessibility | in thermostats | K.1 |
| ultraviolet radiation, see ultraviolet radiation | | asbestos, not to be used as insulation | 2.9.1 |
| with a tool | 1.7.2.5 | attitude | see orientation |
| actuators, mechanical, in SAFETY INTERLOCK system | 2.8.5, 2.8.8 | audio amplifiers | 2.1.1.9, 4.5.1, 5.3.6 |
| acoustic noise hazard | 0.2.6 | AWG (American Wire Gage) | 2.6.3.3 (Table 2D), 3.2.5.1 (Table 3B) |
| additional requirements to those in this standard | 1.1.2 | B | |
| additional equipment | 3.5.4 | backup | |
| adhesive | | overcurrent protection | 2.7.3 |
| ageing test | 4.6.5 | source of power | see multiple power sources |
| application | 2.10.5.5 (note 2), 4.3.2 | baffle in bottom of FIRE ENCLOSURE | 4.6.2 |
| foil | 5.1.4, 5.2.2, 6.2.2 | ball pressure test on thermoplastic part | 4.5.5 |
| tape, as insulating material | 4.7.3.4 | bandwidth of measuring instrument | 1.4.7, S.1 |
| adjustment | | barrier | 0.2.3 |
| marking | | for electrical separation | 2.9.4 a) |
| for rated voltage | 1.7.4 | for power connection | 3.1.9 |
| for thermostats etc. | 1.7.10 | in bottom of FIRE ENCLOSURE | 4.6.2 |
| mechanical actuators | 2.8.8 | in TRANSPORTABLE EQUIPMENT | 4.6.4 |
| must not create a hazard | 4.3.3 | no mechanical strength test within MECHANICAL ENCLOSURE | 4.2.1 |
| worst case conditions for test | 1.4.4, 1.4.10, 2.1.1.1, 2.1.1.5, 2.1.1.8, 2.5, 4.3.8, Annex H, Annex X | secured with adhesive | 4.6.5 |
| air gap | | to prevent ignition | 4.6.2, 4.7.3.1, 4.7.3.4, 4.7.3.5 |
| behind conductive ENCLOSURE | 2.10.3.1, 4.2.1, G.6 | BASIC INSULATION | 0.2.1, 1.2.9.2*, 1.2.9.3, 1.2.9.4, 1.2.9.5 (note) |
| CLEARANCE applicable | 2.10.3.1, G.6 | application | 2.1.1.1, 2.9.3 |
| CLEARANCE not applicable | 2.10.3.1, G.6 | in | |
| disconnect device | 3.4.2 | a contact gap | 2.8.7.1, 3.4.2 |
| mechanical force tests, if over 1 kV | 4.2.1 | an ELV CIRCUIT | 1.2.8.7, 2.1.1.3 |
| SAFETY INTERLOCK switch | 2.8.7.1 | a FUNCTIONAL EARTHING circuit | 2.6.2 |
| tip of test finger if voltage is over 1 kV | 2.1.1.1 and Figure 2D | an SELV CIRCUIT | 2.2.4, 2.9.4 |
| altitude (elevation) during operation | 0.1, 1.1.2, 2.10.3.1, G.6 | a TNV CIRCUIT | 2.3.2.2, 2.3.3, 2.3.4 |
| ampacity | | a wound component | 2.10.5.11, Annex U |
| see current carrying capacity and wiring terminals, ampacity | | on coated printed board | 2.10.6, Annex F (Figure F.11) |
| antenna | 7.1 (note 2), 7.4.1, N.2 (Table N.1/Footnote c) | BASIC and SUPPLEMENTARY can be interchanged | 2.9.3 |
| as a CABLE DISTRIBUTION SYSTEM | 1.2.13.14 | | |
| aperture | see opening in an ENCLOSURE | | |
| appliance coupler | Annex P (IEC 60320) | | |

| | |
|---|---|
| bridging | see bridging of insulation |
| consequences of failure | 2.2.1, 2.2.3, 2.3.2.1, 2.4.1, 2.6.1 |
| dimensions | 2.10.3, 2.10.4, 2.10.5 , Annex F, G.6, R.2 |
| electric strength | 5.2 |
| failure to be simulated | 1.4.14, 2.3.2.3, 2.6.3.4 |
| integrity | |
| after a test | 5.3.4, 5.3.9.2 |
| in service | 3.3.8 |
| one element of DOUBLE INSULATION | 1.2.9.4, 2.10.2.1 e), 5.2.2, 5.3.9.2 |
| WORKING VOLTAGE | 2.10.2 |
| battery | |
| as SECONDARY CIRCUIT | 1.2.8.5 |
| battery-powered equipment | 1.1.1, 2.10.3.2 d), G.2.4 |
| external to equipment | 1.2.8.2 |
| in a limited power source | 2.5 |
| replaceable | 1.7.13, 4.3.8 |
| requirement | 2.1.1.8, 4.3.8 |
| battery backup systems, not in Scope of this standard | 1.1.3 |
| battery compartment, access to a TNV CIRCUIT | 2.1.1.1, 2.1.1.2 |
| bead, ceramic | 3.1.5 |
| OPERATOR access | 2.1.1.1 (note 1) |
| belt | 2.1.1.1, 2.9.1, 4.7.3.3, 4.7.3.4 |
| Bib (Bibliography follows Annex BB) | |
| body (human) | |
| current through | 0.2.1, 5.1.4 (note 1), 5.1.6, Annex W, Bib |
| <i>see also</i> TOUCH CURRENT | |
| BODY (of equipment) | 1.2.7.5* |
| conductive | 1.6.4, 2.9.3 (Table 2H), 3.2.6, 5.1.3, 5.2.2 (Table 5B) |
| effect of ultraviolet radiation | 4.3.13.4 |
| bonding <i>see</i> PROTECTIVE BONDING CONDUCTOR <i>and</i> protective earthing and bonding | |
| BOUNDING SURFACE | 1.2.10.1, 1.2.10.2, 1.2.10.3*, 2.9.3 2.10.3.1, 2.10.4.3, G.6 |
| breakdown (of insulation) <i>see</i> failure (of insulation) | |
| bridging of insulation | 1.5.7, 2.9.3, 6.1.2.1 |
| by | |
| capacitor | 1.5.6, 1.5.8, 5.2.2 (notes 3 <i>and</i> 4) |
| conductive object | 2.1.1.5 b), 2.1.2, 2.1.3, 3.1.9, 4.6.1, 4.6.4, C.2 |
| resistor | 1.5.7, 5.2.2 (note 4) |
| surge suppressor including a VDR | 1.5.9, 6.1.2.1 |
| components removed for test | |
| <i>see</i> components, removal during a test | |
| in TRANSPORTABLE EQUIPMENT | 4.6.4 |
| <i>see also</i> energy hazard <i>and</i> short-circuit of insulation for test | |
| building installation (fixed wiring) | |
| 1.2.4.1, 1.2.5.1, 1.2.5.2, 1.2.5.4, 1.2.13.10 | |
| <i>see also</i> IEC 60364, all parts | |
| disconnection device in | 3.4.6, 3.4.7 |
| not in Scope of this standard | 1.1.3 |
| short-circuit backup protection | 2.7.3 |
| special earthing requirements | 5.1.7.1, Bib (IEC 364-7-707) |
| building wiring | see building installation |
| building-in | see equipment for building-in |
| burn hazard | 0.2.1, 0.2.2, 0.2.3, 0.2.4 |
| <i>see also</i> flammability | |
| busbar | |
| as internal wiring | 3.1.1 |
| as PROTECTIVE EARTHING CONDUCTOR | 2.6.4.3 |
| colour | 2.6.3.5 |
| bushings | |
| as cord anchorage | 3.2.6 |
| in metal | 3.1.2 |
| power cord | 3.2.7, 3.2.8 |
| business equipment | 1.1.1 |
| normal load conditions | Annex L |
| C | |
| CABLE DISTRIBUTION SYSTEM | 0.1, 1.1.1, 1.2.13.14*, Clause 7 |
| coaxial cable | 1.2.13.14, 7.1 (notes 1 <i>and</i> 5), 7.3 |
| connected to a circuit in equipment | 2.2.2 (note 1), 7.2 |
| connections to | 1.2.11.6, Clause 7 |
| disconnection marking | 2.3.2.3 |
| earthing requirements | 2.6.1 c), d) <i>and</i> f), 2.6.3.4 e), 5.1.8.1, 7.2, 7.3 |
| insulation | 7.4.1 |
| not a reliable earth | 2.6.5.8 |
| not a TELECOMMUNICATION NETWORK | 1.2.13.8, 7.1 (note 4) |
| TOUCH CURRENT | 2.6.1 f), 5.1.8.1 |
| transients | 1.2.9.11 (note), 1.2.13.14, 2.10.3.8, G.1.2 (note 2), G.4.4 |
| CABLE, INTERCONNECTING | |
| <i>see</i> INTERCONNECTING CABLE | |
| cable | |
| coaxial | 1.2.13.14, 7.1 (notes 1 <i>and</i> 5), 7.3 |
| earthing conductor, colour of insulation | 2.6.2, 2.6.3.5 |
| FIRE ENCLOSURE not required | 4.7.2.2 |
| power | 3.3.4, 3.3.5, Annex P (IEC 60227, IEC 60245, IEC 60885-1) |
| sheath is SUPPLEMENTARY INSULATION | 3.1.4 |
| telecommunication, wire size | 6.3 (note 2) |
| television distribution | 1.2.13.14 |
| ultraviolet radiation, effect of | 4.3.13.3 |
| calibre of conductor | see current carrying capacity |
| capacitors | |
| application | 1.5.6, (Table 1D) |
| bridging insulation | 1.5.6 |
| class X (IEC 60384-14) | 1.5.6 |
| class Y (IEC 60384-14) | 1.5.6, 1.5.8 |
| connected to IT power distribution system | 1.5.8 |
| energy hazard | 1.2.8.10, 2.1.1.5 |
| failure | 1.4.14 |
| IEC 60065 | 4.7.3.6 |
| in filter | 1.5.6, 1.5.8, 5.2.2 (notes 3 <i>and</i> 4) |
| discharging | 2.1.1.7, 2.1.1.8 |
| in FIRE ENCLOSURE | 4.7.3.4 |
| motor | B.5, B.8 |
| not protected by fuse | 5.3.8 |
| outside FIRE ENCLOSURE | 4.7.3.3 |
| ratings | (Table 1C) |
| separate testing <i>see</i> separate testing | |
| stored charge | 2.1.1.7, 2.1.1.8, 2.4.2 |

- cathode ray tube, mechanical strength
 0.2.5, **4.2.8**, Annex P (IEC 61965)
 no test 4.2.1, 4.2.5
- CCITT Recommendations *see* ITU-T Recommendations
 Note - CCITT Recommendations are now ITU-T Recommendations
- ceiling-mounted equipment **4.2.10**
- cemented joints
 in insulation **2.10.5.5**, 2.10.6.3, 2.10.11,
 Annex F (Figures F.5, F.6, F.7, F.16 and F.18)
 in winding wire 2.10.5.12
- ceramic and glass insulation 2.10.6.4 (Table 2R/note 2)
 CREEPAGE DISTANCE 2.10.4.3
 flammability, no test 4.7
 on printed board 2.10.6.4 (Table 2R)
 temperature during a test 4.5.4 (Table 4C), 5.3.9.1
 see also bead, ceramic
- CFR 47, part 68 M.3 (note), Bib
- changes in this edition of the standard Foreword, Annex BB
- chemical hazard 0.2.7
 in battery 4.3.8
 ozone 1.7.2.6
 see also corrosion
- CHEESECLOTH 1.2.13.15*, A.3.1, A.3.2, A.3.3, B.6.3, B.7.3
- CIE (Commission Internationale de l'Eclairage)
 Publication 63 4.3.13.4 (note 3), Bib
- circuit characteristics (definitions) 1.2.8*
- circuit-breaker
 CLEARANCE between contacts not applicable 2.10.3.1, G.6
 see also fuse and overcurrent and earth fault protection
- circuit
 ELV *see* ELV CIRCUIT
 interconnection 3.5.1, 3.5.2
 LIMITED CURRENT *see* LIMITED CURRENT CIRCUIT
 PRIMARY *see* PRIMARY CIRCUIT
 SECONDARY *see* SECONDARY CIRCUIT
 SELV *see* SELV CIRCUIT
 TNV *see* TNV CIRCUIT
- classification of equipment
 (for protection against electric shock) 1.2.4*
- CLASS I EQUIPMENT 1.2.4.1*, W.1
- CLASS II EQUIPMENT 1.2.4.2*, 1.7.1, W.1
- CLASS III EQUIPMENT 1.2.4.3*
- CLEARANCE 1.2.10.1*, **2.10.3**, Annex F, **Annex G**
 as FUNCTIONAL INSULATION 2.10.1.3, 5.3.4
 as minimum CREEPAGE DISTANCE 2.10.4.3
 behind conductive ENCLOSURE 2.10.3.1, 4.2.1, G.6
 divided by floating part 2.10.1.4, Annex F (Figure F.13)
 in
 coated board 2.10.6.2
 disconnect device 3.4.2
 encapsulated part 2.10.5.3
 enclosed part 2.10.12
 uncoated board 2.10.6.1
 increased by coating 2.10.7
- integrity in service 2.10.3.1, C.2
 measured through an opening
 2.10.3.1, Annex F (Figure F.12), G.6
- overvoltage categories 2.10.3.1, G.1.1, **Annex Z**
 reduced R.2
 varying 2.10.1.5
 WORKING VOLTAGE 2.10.2
 see also IEC 60664 (all parts), interpolation,
 TELECOMMUNICATION NETWORK TRANSIENT VOLTAGE,
 transients and separation distances
- cmil *see* AWG
- coated printed board **2.10.6.2**, Annex F (Figure F.11), R.1
- colours
- controls and indicators
 1.7.8.2, Annex P (IEC 60073, ISO 3864)
- flexible printed wiring 2.6.3.5
 FUNCTIONAL EARTHING CONDUCTOR 2.6.2
 PROTECTIVE EARTHING CONDUCTOR 2.6.3.5, 3.2.5.1
- comparative tracking index (CTI) *see* tracking
- compliance checked by inspection of relevant data **1.4.15**
 see also separate testing
- component 1.2.11*
 bridging insulation *see* bridging of insulation
 electromechanical *see* electromechanical component
 high voltage 4.7.3.6
 material selection 4.7.3
 removal during a test 2.10.3.9, 5.1.5, 5.2.2, 6.1.2.1,
 6.2.2.2, 6.2.2.3, 7.4.2, 7.4.3
 selection 0.3, **1.5.1**, 1.5.8, 4.7.1
 separate testing *see* separate testing
 used within its rating 1.5.2, 1.5.6, 1.6.4
 wound 2.10.5.11, 5.3.5, Annex U
 see also capacitor, resistor, sealed components,
 semiconductor device and transformers
- conditioning of test samples 2.9.2,
 2.10.6.4 (Table 2R/Footnote a), 2.10.8.2, 2.10.8.3,
 2.10.9, 2.10.10, 2.10.11, 4.3.13.3, 4.6.5, 4.7.3.6,
 7.4.2, 7.4.3, A.1.2, A.2.2, R.1, Annex Y
- conductive liquid *see* liquid, conductive
- conductor size *see* current carrying capacity
- conductor *see* busbar and wire, wiring
- connection terminals *see* wiring terminals
- connections
 between circuits 2.2.4, 2.3.4, 2.4.3
 FUNCTIONAL EARTHING **2.6.2**
 to
 CABLE DISTRIBUTION SYSTEM 1.1.1, 2.2.2 (note 1), **Clause 7**
 multiple power sources *see* multiple power sources
 other equipment *see* interconnection of equipment
 protective earth **2.6**
 supply source 1.2.5*, 3.1, 3.2, 3.3, 5.1.2
 TELECOMMUNICATION NETWORK 1.1.1, 1.4.11,
 2.2.2 (note 1), **Clause 6**, Bib (CFR 47, part 68)
 see also disconnection and INTERCONNECTING CABLES
- connectors
 contact by test probe 2.1.1.1, 2.10.4.3, 6.2.1, 6.6
 FIRE ENCLOSURE not required 4.7.2.2
 flammability 4.7.2.2, 4.7.3.2, 4.7.3.3, 4.7.3.4

| | | |
|--|--|--|
| mismatching, not to create a hazard | 4.3.5 | 2.6.3.3, 3.2.3 (Table 3A), 4.7.2.2, 4.7.3.1, 5.3.7, Clause 6 |
| multiway | 3.1.9 | |
| power | 3.2 | |
| protective earthing contact in | 2.6.4.2, 2.6.5.4 | |
| <i>see also</i> appliance coupler, appliance inlet, mains plug and socket-outlet | | |
| construction | | |
| details | 4.3 | |
| general requirements | 1.3.1, 1.3.2 | |
| not covered by this standard | 1.3.4 | |
| consumable supplies | | |
| 0.2.3, 0.2.7, 1.4.14, 4.7.3.2, 4.7.3.3, 4.7.3.4 | | |
| contact | | |
| gap <i>see</i> air gap | | |
| pressure | 3.1.6, 3.1.7, 3.3.6, 3.3.8 | |
| <i>see also</i> access | | |
| control, quality <i>see</i> quality control | | |
| controls | | |
| manual | 2.1.1.6 | |
| accessibility | 4.3.3 | |
| fixing | 4.3.2 | |
| operated during a test | 1.4.4, 5.1.5, 5.1.8.1, 5.3.8, Annex H | |
| marking | 1.7.8 | |
| supply voltage adjustment | 1.7.4, 4.3.3 | |
| temperature | 4.5.4 (Table 4C) | |
| <i>see also</i> colours and symbols, informative | | |
| cord anchorage, power cord | 3.2.6 | |
| cord guard (for power cord) | 3.2.7, 3.2.8 | |
| integral with cord | 1.2.5.6 | |
| cord, telephone | 2.1.1.2 | |
| cord, power supply <i>see</i> power supply cord | | |
| corrosion | | |
| by consumable materials | 4.3.10 | |
| by electrochemical action | Annex J | |
| by environment | 1.1.2 | |
| in protective earthing connection | 2.6.5.6 | |
| country notes <i>can be found in the following subclauses:</i> | | |
| general | 1.1.2, 1.2.13.10, 1.7.2.1, 2.6.3.3 (Table 2D), 3.2.1.1, 3.2.5.1 (Table 3B), 6.1.2.1, M.1, Annex V (Figure V.4) | |
| Australia | 3.2.5.1, 4.3.6, 4.7, 6.2.2, 6.2.2.1, 6.2.2.2 | |
| Canada | 1.4.8, 1.7.2.1, 2.2.3, 2.3.2.1, 2.6.3.3, 3.2.3 (Table 3A), 4.7.2.2, 4.7.3.1, 5.3.7, Clause 6 | |
| CENELEC countries | 2.7.1, Annex H | |
| Denmark | 5.1.7.1 | |
| France | Annex V (Figure V.7) | |
| Germany | 1.7.2.1 | |
| Finland | 1.5.9.4, 1.7.2.1, 2.3.2, 2.10.5.13, 5.1.7.1, 6.1.2.1, 6.1.2.2, 7.2 | |
| Japan | 2.10.3.2 | |
| Norway | 1.5.8, 1.5.9.4, 1.7.2.1, 2.2.4, 2.3.2, 2.3.4, 2.10.5.13, 5.1.7.1, 6.1.2.1, 7.2, 7.3, 6.1.2.2, 7.2, 7.3, Annex V (Figure V.7) | |
| Sweden | 1.5.1, 1.5.9.4, 1.7.2.1, 2.3.2, 2.10.5.13, 5.1.7.1, 6.1.2.1, 6.1.2.2, 7.2, 7.3 | |
| Switzerland | 1.5.1 | |
| United Kingdom | 2.6.3.3, 3.2.1.1, 4.3.6 | |
| United States of America | 1.4.8, 2.2.3, 2.3.2.1, | |
| | | 2.6.3.3, 3.2.3 (Table 3A), 4.7.2.2, 4.7.3.1, 5.3.7, Clause 6 |
| covering, protective, in place during a test | | 5.3.1 |
| covers <i>see</i> doors and covers | | |
| CREEPAGE DISTANCE | 1.2.10.2*, 2.10.4, Annex F | |
| as FUNCTIONAL INSULATION | 2.10.1.3, 5.3.4 | |
| divided by floating part | 2.10.1.4, Annex F (Figure F.13) | |
| in cemented joints | 2.10.5.5 | |
| in coated boards | 2.10.6.2 | |
| in encapsulated part | 2.10.5.3 | |
| in enclosed part | 2.10.12 | |
| in groups of resistors | 1.5.7.2 | |
| increased by coating | 2.10.7 | |
| integrity in service | 2.10.3.1, C.2 | |
| measured through an opening | 2.10.4.3, Annex F (Figure F.12) | |
| not less than CLEARANCE | 2.10.4.3 | |
| varying | 2.10.1.5 | |
| WORKING VOLTAGE | 2.10.2, 2.10.4.3 | |
| <i>see also</i> IEC 60664, interpolation, and separation distances | | |
| CTI (comparative tracking index) <i>see</i> tracking | | |
| current | | |
| in human body | 0.2.1, 5.1 | |
| input, determination | 1.4.10 | |
| input, maximum | 1.6.2 | |
| limiter | 2.5 | |
| locked rotor | B.1, B.5 | |
| maximum ringing signal | M.2, M.3 | |
| r.m.s. value implied unless otherwise specified | 1.2 | |
| to telecommunication wiring | 6.3 | |
| <i>see also</i> PROTECTIVE CONDUCTOR CURRENT, TOUCH CURRENT and RATED CURRENT | | |
| current-carrying capacity | | |
| INTERCONNECTING CABLE | 3.1.1 | |
| internal wiring | 3.1.1 | |
| power supply cord | 3.2.5.1, 3.2.5.2 | |
| PROTECTIVE BONDING CONDUCTOR | 2.6.3.3 | |
| PROTECTIVE EARTHING CONDUCTOR | 2.6.3.2 | |
| telecommunication wiring | 6.3 | |
| wiring terminals | | <i>see</i> wiring terminals, current carrying capacity |
| CUT-OUT, THERMAL <i>see</i> THERMAL CUT-OUT | | |
| D | | |
| data port | | 3.5.4 |
| d.c. component of waveform | 1.2.9.7, 1.2.9.8, 1.4.7, 2.3.1 b) | |
| <i>see also</i> ripple | | |
| d.c. current for test | | 2.6.3.4 |
| DC MAINS SUPPLY | 1.2.8.2*, 1.2.8.3 | |
| capacitor | 2.1.1.7, 2.1.1.8 | |
| circuitry considered to be a SECONDARY CIRCUIT | 1.2.8.2 | |
| connections | 3.2.1.2, 3.2.5.2 | |
| energy hazard | 2.1.1.8 | |
| isolation <i>see</i> disconnection | | |
| marking | 1.7.1 | |
| overvoltage category not applicable | Annex Z | |
| polarity | 1.4.5, 1.7.7.3 | |
| power cord | 3.2.5.2 | |
| protective conductor sizing | 2.6.3.4 | |

| | | | |
|---|--|--|--|
| terminals | 1.7.7.3, 3.3.7 | | |
| test voltage | 5.2.2 (Table 5B/Footnotes a, b, c and d) | | |
| TOUCH CURRENT requirements not applicable | 5.1 | | |
| tolerance | 1.4.5 | | |
| transients | 2.10.3.2, 2.10.3.7, 2.10.3.9, G.2.2, G.2.3, G.5 a) | | |
| | <i>see also</i> mains and PRIMARY CIRCUIT | | |
| d.c. power supply distribution system | | | |
| | <i>see</i> power distribution system, d.c. | | |
| d.c. motor, testing | B.1, B.6, B.7, B.10 | | |
| d.c. voltage | | | |
| for test, instead of a.c. | | | |
| | <i>Note - where electric strength testing is required, a d.c. test voltage is permitted, see 5.2.2</i> | | |
| for testing a capacitor | 5.2.2 (note 3) | | |
| | <i>see also</i> ripple | | |
| DC VOLTAGE | 0.2.1, 1.2.13.4* | | |
| DECORATIVE PART | 1.2.6.5*, 4.7.3.1 (note 2), 4.7.3.3 | | |
| | <i>see also</i> ENCLOSURE | | |
| definitions | 1.2* | | |
| miscellaneous | 1.2.13* | | |
| design, general requirements | 0.1, 1.3, 4.3, 4.7.1, 5.3.1 | | |
| DETACHABLE POWER SUPPLY CORD | <i>see</i> power supply cord | | |
| different criteria and tests in this standard, | | | |
| manufacturer's choice | 1.3.7, 1.5.6, 2.3.2.1, R.1, R.2 | | |
| DIRECT PLUG-IN EQUIPMENT | 1.2.3.6*, 3.2.1.1, 3.4.2, 4.2.6, 4.3.6 | | |
| disconnection | | | |
| automatic | 2.7, 5.3.2 (note) | | |
| by a SAFETY INTERLOCK | 2.8.2 | | |
| for servicing (isolation) | 3.4 | | |
| from CABLE DISTRIBUTION SYSTEM | 2.3.2.3 b) | | |
| from protective earth | 2.6.5.3, 2.6.5.5 | | |
| from TELECOMMUNICATION NETWORK | 2.1.1.2, 2.3.2.3 b) | | |
| marking | 1.7.2.2, 1.7.9 | | |
| of components, during a test | | | |
| <i>see</i> component, removal during a test | | | |
| of heating element | 4.3.7 | | |
| distance through insulation | 2.10.5.2, 2.10.5.3 | | |
| printed board | 2.10.6.4 | | |
| varying | 2.10.1.5, 5.2.2 | | |
| wiring in an ELV CIRCUIT | 2.1.1.3 | | |
| doors and covers | 4.2.3, 4.6.1, 4.6.3 | | |
| access through | | | |
| <i>see</i> opening in an ENCLOSURE, access | | | |
| marking on or near | 1.7.1, 2.1.1.2, 4.3.13.4 | | |
| of supply wiring space | 3.2.9 | | |
| position during a test | 2.1.1.1, 4.1, 4.3.13.4, 4.4.2, 4.6.4 | | |
| transparent, no mechanical strength test | 4.2.1 | | |
| DOUBLE INSULATION | 0.2.1, 1.2.9.4*, 1.2.9.5 | | |
| application | 2.9.3 | | |
| in | | | |
| a FUNCTIONAL EARTHING circuit | 2.6.2 | | |
| a HAZARDOUS VOLTAGE circuit | 2.1.1.4 | | |
| manual control | 2.1.1.6 | | |
| an SELV CIRCUIT | 2.2.4, 2.9.4 | | |
| a TNV CIRCUIT | 2.3.3, 2.3.4 | | |
| a wound component | 2.10.5.11, Annex U | | |
| BASIC and SUPPLEMENTARY can be interchanged | 2.9.3 | | |
| bridging | <i>see</i> bridging of insulation | | |
| care during electric strength tests | 5.2.2 | | |
| dimensions | | | |
| | <i>see</i> BASIC INSULATION and SUPPLEMENTARY INSULATION | | |
| integrity | | | |
| after a test | 5.3.9.2 | | |
| in service | 3.3.8 | | |
| protective device not needed | 2.7.4 | | |
| unearthed parts within | 2.9.3 | | |
| WORKING VOLTAGE | 2.10.2 | | |
| meaning, for DOUBLE INSULATION | 2.10.2.1 e) | | |
| drop test | 4.2.6 | | |
| dust | | | |
| additional requirements if present | 1.1.2, 4.3.10 | | |
| excluded in pollution degree 1 | 2.10.1.2 | | |
| explosion limit | 1.2.12.15* | | |
| duty cycle, marking | | | |
| <i>see</i> RATED OPERATING TIME and RATED RESTING TIME | 1.7.3 | | |
| E | | | |
| earth, earthing | 0.2.1, 2.6 | | |
| a.c. power distribution system | Annex V | | |
| functional earthing | 1.2.13.9*, 2.6.2 | | |
| permanent connection to earth | 1.5.9.4, 2.3.2.3 a), 2.6.4.2, 5.1.7.1, 5.1.8.2, 6.1.2.2, 6.2.1, 7.4.1 | | |
| | <i>see also</i> permanently connected equipment | | |
| protective | | | |
| <i>see</i> protective bonding conductor, protective earthing and bonding, protective earthing conductor and screen, conductive, earthed | | | |
| rise of earth potential, not covered by this standard | 1.4.8 (note 1) | | |
| special requirements | Bib (IEC 60364-7-707) | | |
| voltage measurement to earth | 1.4.9 | | |
| earth fault protection | 2.7 | | |
| | <i>see also</i> overcurrent protection devices | | |
| earth leakage current | <i>see</i> TOUCH CURRENT | | |
| electric shock | 0.2.1, 1.3.2 | | |
| caused by | | | |
| stored charge | 2.1.1.7, 2.1.1.8 | | |
| touching bare conductive part | 2.1.1, 5.1 | | |
| classes of equipment | 1.2.4* | | |
| protection | 2.1 | | |
| by insulation | 1.2.9* | | |
| by a SAFETY INTERLOCK | 2.8.2 | | |
| by an SELV CIRCUIT | 2.2 | | |
| by a TNV CIRCUIT | 2.3 | | |
| two levels | 0.2.1 | | |
| | <i>see also</i> symbols, warning | | |
| electric strength test | 5.2 | | |
| not for verifying CLEARANCE | 2.10.3.1, G.6 | | |
| test voltage, based on | | | |
| PEAK WORKING VOLTAGE | 5.2.2 (Table 5B) | | |
| REQUIRED WITHSTAND VOLTAGE | 5.2.2 (Table 5C) | | |
| used for verifying SOLID INSULATION | 2.10.5.1 | | |
| with or without pre-heating | 5.2 (note), 5.2.1 | | |
| WORKING VOLTAGE | 2.10.2 | | |
| | <i>Note - electric strength tests are required in numerous places in this standard</i> | | |

| | | | |
|--|--|---|---|
| ELECTRICAL ENCLOSURE | | to be taken into account in design | 2.6.5.6, 2.9.1 |
| <i>see</i> ENCLOSURE <i>and</i> opening in an ENCLOSURE | | <i>see also</i> corrosion, humidity, pollution degree, <i>and</i> temperature | |
| electrical filter | | equipment | |
| effect of | 2.10.3.2, 2.10.3.4, 2.10.3.9, G.5 | electrical ratings (definitions) | 1.2.1* |
| electric strength test | 5.2.2 (notes 3 <i>and</i> 4) | not operational after a test | 1.4.1 |
| fault testing | 5.3.7 | EQUIPMENT FOR BUILDING-IN | 1.2.3.5*, 2.1.1.1, 4.2.5, 4.5.2 |
| three-phase, during a TOUCH CURRENT test | 5.1.5 (note) | equivalent level of safety | 1.3.4 |
| electrochemical potential | 2.6.5.6, Annex J | equivalent materials permitted | 1.3.5 |
| electromechanical component | 2.5, 2.8.4, 2.8.5, 4.7.2.2, 5.3.5 | equivalent sources of power | 1.2.8.1, 1.4.5 |
| elevation <i>see</i> altitude | | EUT (equipment under test) | |
| ELV CIRCUIT | 1.2.8.7* | examples given in this standard, others not excluded | 1.3.8 |
| accessibility | 2.1.1.1, 2.1.1.6, 3.2.2 | explosion | |
| in a SERVICE ACCESS AREA | 2.1.2 | EXPLOSION LIMIT | 1.2.12.15*, 4.3.12 |
| of insulation | 2.1.1.3 | external to the equipment | |
| as an interconnection circuit | 3.5.2, 3.5.3 | batteries | 4.3.8 (note 3) |
| insulation | 2.9.3 | (impllosion) of cathode ray tube | 0.2.5, 4.2.8 |
| operating voltage | 1.4.8 | of battery | 1.7.13, 4.3.8 |
| reed switch in | 2.8.7.3 | of high pressure lamp | 0.2.5, 4.2.9 |
| similar to an SELV CIRCUIT | 2.2.2 (notes 1 <i>and</i> 2) | <i>see also</i> transients | |
| e.m.c. <i>see</i> electrical filters | | external to the equipment | |
| enamel, solvent-based | | batteries, explosion | 4.3.8 (note 3) |
| as FUNCTIONAL INSULATION | 2.1.1.1 (note 1) | disconnect devices | 1.7.2.2, 3.4.3, 3.4.6, 3.4.7 |
| as insulation for safety | 2.10.5.12, 2.10.5.13, 2.10.11 | overcurrent protective devices | 2.6.3.3, 2.6.3.4, 2.7.1, 2.7.4, 2.10.3.2, 3.4.7, C.1 |
| encapsulated part | 2.10.5.3, 5.1.5 (note) | protection for high overvoltage categories | 2.10.3.2 |
| enclosed part | 2.10.12 , B.2, B.5, 5.3.9.2 | <i>see also</i> building installation, disconnection, <i>and</i> overcurrent protective devices | |
| ENCLOSURE | 1.2.6.1*, 5.3.9.1 | F | |
| bottom | 4.2.4, 4.2.5, 4.6.1, 4.6.2 , A.3 | failure <i>see</i> fault or failure | |
| definition | 1.2.6* | fault or failure | 1.3.2, 5.3.1 |
| ELECTRICAL ENCLOSURE | 1.2.6.4*, 2.1.1.1, 4.7.3.3, 4.7.3.4 | component | 0.1, 0.2.1, 0.2.3, 2.2.3, 5.3.7 |
| FIRE ENCLOSURE <i>see</i> FIRE ENCLOSURE | | in a battery circuit | 4.3.8 |
| flammability | 4.7.3.2, A.1, A.2 | in a LIMITED CURRENT CIRCUIT | 1.2.8.9, 2.4.1, 2.4.3 |
| MECHANICAL ENCLOSURE | 1.2.6.3*, 4.2 , 4.4 | in an SELV CIRCUIT | 1.2.8.8, 2.2.1, 2.2.4 |
| mechanical strength | 4.2 | in a TNV CIRCUIT | 1.2.8.11, 2.3 |
| metallized plastic, in TRANSPORTABLE EQUIPMENT | 4.6.4 | consequences | 1.3.1, 2.9.3 |
| <i>see also</i> air gap behind conductive ENCLOSURE, DECORATIVE PART, water ingress <i>and</i> opening in an ENCLOSURE | | consequential | 0.1, 0.2.1, 1.4.14, 5.3.5 |
| endurance testing | | earth fault protection | 2.7, 4.3.7 |
| capacitors | 1.5.8 (note 1) | earthed equipment | 2.6.1 |
| SAFETY INTERLOCK switch | 2.8.5, 2.8.7.3 | ENCLOSURE | 4.2.5, 4.7 |
| thermal control | Annex K | metallized ENCLOSURE | 4.6.4 |
| energy hazard | 0.2.2, 5.3.9.1 | equipment not operational, evident to an OPERATOR | 5.3.5 |
| AC MAINS SUPPLY | 2.1.1.7 | mechanical | 5.3.5 |
| DC MAINS SUPPLY | 2.1.1.7, 2.1.1.8 | motor capacitor | B.8 |
| disconnection | 3.4.10 | moving part | 4.2.1 |
| in | | not covered in subclause 5.3 | 2.7.2 |
| ENCLOSURE | 4.2.1, 4.6.1 (note 1) | power distribution system | 1.2.13.8 (note 2) |
| FIRE ENCLOSURE | 4.7.2.1 | protective earthing connection | 5.1 |
| OPERATOR ACCESS AREA | 2.1.1, 2.1.1.5 , 2.1.1.8 | ringing signal circuit | M.2, M.3 |
| RESTRICTED ACCESS LOCATION | 2.1.3 | SAFETY INTERLOCK system | 2.8.4 |
| SERVICE ACCESS AREA | 2.1.2 | screwed connection | 4.3.4 |
| multiple sources | 1.7.9 | simulated fault condition or abnormal condition | 1.4.14, 2.3.2.2, 2.3.2.3, 2.3.2.4, 2.3.4, 2.5 c), 2.7.4, 2.8.4, 4.3.8, 5.1.5, 5.3.5, 5.3.7 |
| reduced by a SAFETY INTERLOCK | 2.8.2 | single fault | 0.2.1, 1.4.14 |
| ENERGY LEVEL, HAZARDOUS | | <i>see also</i> abnormal condition | |
| <i>see</i> energy hazard <i>and</i> HAZARDOUS ENERGY LEVEL | | | |
| environment of equipment | | | |
| manufacturing | R.1, R.2 | | |
| special | 1.1.2 | | |

| | | | |
|--|--|--|--|
| fault current | 2.7 | HB75 | 1.2.12.1 (notes 2 and 5), 1.2.12.11* |
| in protective earthing conductor | 2.6.1 (note), 2.6.3 | application | 4.7.2.2, 4.7.3.3, 4.7.3.4, 4.7.3.5 |
| FCC Rule, Part 68 | M.3 (note), Bib | glow-wire test acceptable | 4.7.3.1 |
| FEP (fluoro ethylene propylene) | 4.7.2.2, 4.7.3.3, 4.7.3.4 | HBF (foamed material) | 1.2.12.1 (note 1), 1.2.12.9* |
| filter, air, flammability | 4.7.3.5 | application | 4.7.2.2, 4.7.3.3, 4.7.3.4, 4.7.3.5 |
| filter, electrical <i>see</i> electrical filter <i>and</i> capacitors in filters | | glow-wire test acceptable | 4.7.3.1 |
| FIRE ENCLOSURE | 1.2.6.2* | HF-1 (foamed material) | 1.2.12.1 (note 1), 1.2.12.7* |
| air filter in | 4.7.3.5 | application | 4.6.2 |
| construction | 4.6.2, 4.6.3, 4.7.1, 4.7.2, A.1, A.2 | HF-2 (foamed material) | 1.2.12.1 (note 1), 1.2.12.8* |
| material | 4.7.3.2 | application | 4.7.3.4, 4.7.3.5, 4.7.3.6 |
| not required | 1.4.11 (note), 4.7.2.2 | V-0 | 1.2.12.1 (notes 2 and 4), 1.2.12.2* |
| required | 4.7.2 | <i>Note - V-0 CLASS is not required in this standard</i> | |
| screen may be part of FIRE ENCLOSURE | 4.6.4.1 (note) | V-1 | 1.2.12.1 (notes 2 and 4), 1.2.12.3* |
| <i>see also</i> ENCLOSURE <i>and</i> opening in an ENCLOSURE | | application | 4.6.2, 4.7.2.1, 4.7.2.2, 4.7.3.1, 4.7.3.2, 4.7.3.3, 4.7.3.4, 4.7.3.5, 5.3.4 |
| fire hazard | 0.3, 1.1.1, 1.3.2, 4.7 , Annex P (IEC 60695) | V-2 | 1.2.12.1 (notes 2 and 4), 1.2.12.4* |
| caused by | | application | 4.7.3.3, 4.7.3.4, 4.7.3.5, 4.7.3.6 |
| battery | 4.3.8 | VTM-0 | 1.2.12.1 (note 3), 1.2.12.12* |
| breakdown of FUNCTIONAL INSULATION | 1.2.9.1 (note), 5.3.4, 5.3.9 | equivalent to V-0 | 1.2.12.1 (note 4), 4.7.3.1 |
| flammable liquid | 4.3.10, 4.3.12 | <i>Note - VTM-0 and V-0 CLASSES are not required in this standard</i> | |
| heating element | 4.3.7 | VTM-1 | 1.2.12.1 (note 3), 1.2.12.13* |
| overload | 5.3.1 | equivalent to V-1 | 1.2.12.1 (note 4), 4.7.3.1 |
| water ingress | Annex T | VTM-2 | 1.2.12.1 (note 3), 1.2.12.14* |
| <i>see also</i> flammability | | equivalent to V-2 | 1.2.12.1 (note 4), 4.7.3.1 |
| fixed wiring <i>see</i> building installation | | floating parts and windings | <i>see</i> unearthed parts and windings |
| fixing (securing) of | | foil (conductive) | |
| equipment | 1.2.3.4, 1.2.3.5 | in definitions | 1.2.7.5, 1.2.10.3 |
| units, fixed together | 4.1 | in test | |
| parts | | mandrel test | Annex AA |
| adhesive | 4.6.5 | on a non-conductive surface | 2.10.3.1, 2.10.4.3, 2.10.11, 5.1.4, 5.2.2, 6.2.2, G.6 |
| conductors <i>see</i> wiring terminals | | on wire | 3.1.4 |
| controls | 4.3.2 | metallized plastic | 4.6.4.3 (note) |
| cord guard | 3.2.8 | frequency | |
| insulation | 3.1.5 | higher than 50/60 Hz | 0.2.6, 1.4.7, 5.1.6, 5.2.2 (note 5) |
| inlet bushing | 3.2.7 | in a LIMITED CURRENT CIRCUIT | 2.4.2 |
| minor part | 4.3.4 | in a TNV CIRCUIT | 2.3.1 b), 6.2.2.1 |
| terminal hardware | 3.3.6 | of electric strength test voltage | 5.2.2, R.1, R.2 |
| two fixings not loose at the same time | 3.1.9, 4.3.4, C.2 | of ringing signal | M.2 (note), M.3.1.1 |
| wiring | 2.1.1.3, 2.1.1.4, 3.1.3, 2.9.4 a) | of supply | 1.7.1, 3.2.2, 3.4.11 |
| flammability | 0.2.3, 0.2.4, 1.2.12*, 4.7 | during a test | 1.4.4, 1.4.6 |
| better class permitted | 1.3.5 | of WORKING VOLTAGE | 2.9.1, 2.10.1.1 |
| exemption from flammability requirement | 4.7.3.3, 4.7.3.4 | <i>see also</i> RATED FREQUENCY | |
| of fluids | 4.3.10, 4.3.12 | <i>and</i> RATED FREQUENCY RANGE | |
| ranking (one class better than another) | 1.2.12.1 (notes and Table 1B), 1.3.5 | FUNCTIONAL EARTHING | 1.2.13.9*, 2.6.2 , 2.6.3, 5.1.5, 5.1.8.1 |
| summary of flammability requirements | Table 4E | FUNCTIONAL INSULATION | 1.2.9.1*, 5.3.4 |
| tests | Annex A, Annex P (IEC 60695 series, ISO 9772, ISO 9773) | application | 2.1.1.1, 2.9.3, 2.10.1.7 |
| FLAMMABILITY CLASSES | 1.2.12.1*, 1.3.5, Table 4E | bridging <i>see</i> bridging of insulation | |
| equivalence of V-series and VTM-series | 4.7.3.1 | dimensions | 2.10.3, 2.10.4 , Annex F |
| 5VA | 1.2.12.1 (notes 2 and 5), 1.2.12.5* | coated printed board | 2.10.6, Annex F (Figure F.11) |
| <i>Note - 5VA CLASS is not required in this standard</i> | | distance through insulation, no requirement | 2.10.5.2 |
| 5VB | 1.2.12.1 (notes 2 and 5), 1.2.12.6* | electric strength | 2.10.5.6, 2.10.5.11 |
| application | 4.7.3.2 | failure simulated | 5.2, 5.3.4 b) |
| HB40 | 1.2.12.1 (notes 2 and 5), 1.2.12.10* | integrity after a test | 1.4.14, 5.3.4 c) |
| application | 4.7.2.2, 4.7.3.3, 4.7.3.4, 4.7.3.5 | no protection against electric shock | 5.3.4 |
| glow-wire test acceptable | 4.7.3.1 | smaller spacing permitted | 1.2.9.1 (note) |
| | | WORKING VOLTAGE | 2.10.1.3, 5.3.4 2.10.2 |
| | | <i>Note - the term</i> FUNCTIONAL INSULATION <i>has replaced the term</i> OPERATIONAL INSULATION | |

| | | | |
|--|--|--|--|
| fuse | | | |
| as disconnect device for DC MAINS SUPPLY | 3.4.2 | | |
| current rating | 1.7.6, 2.7.3 (note), 6.3 (note), Bib (IEC 60127, IEC 60269-2-1) | | |
| high breaking capacity | 2.7.3 (note) | | |
| marking | 1.7.6 | | |
| operating during motor test | B.2 | | |
| protecting a capacitor | 5.3.8 | | |
| protecting a limited power source | 2.5 | | |
| protecting telecommunication wiring | 6.3 (notes 1 and 4) | | |
| warning to SERVICE PERSON | 2.7.6 | | |
| | <i>see also</i> overcurrent and earth fault protection | | |
| fuseholder | 2.1.1.1 b), 2.1.1.1 c), 4.7.3.2 (note) | | |
| G | | | |
| gap | <i>see</i> air gap | | |
| gas | | | |
| flammable | 1.1.2, 1.2.12.15, 4.3.10 | | |
| inert, in a sealed unit | 4.7.3.3, 4.7.3.4 | | |
| produced by equipment | 4.3.10 | | |
| under pressure | 4.3.11 | | |
| gas discharge tube | <i>see</i> surge suppressor | | |
| gas flame for flammability testing | A.1.4, A.2.4 | | |
| gel dielectric | 2.10.5.1 | | |
| gel electrolyte | 4.3.8 | | |
| glass | | | |
| cloth, prepreg | 2.10.6.4 (Table 2R/note 1) | | |
| flammability, no test | 4.7 | | |
| platen, no impact test | 4.2.5 | | |
| touch temperature | 4.5.4 (Table 4C) | | |
| | <i>see also</i> ceramic and glass insulation | | |
| glow-wire test | Annex P (IEC 60695-2-1/1) | | |
| acceptable for HB40, HB75 and HBF | 4.7.3.1 | | |
| grease | <i>see</i> oil and grease | | |
| green-and-yellow | <i>see</i> colours | | |
| grips | <i>see</i> handles and levers | | |
| ground, grounding, | <i>see</i> earth, earthing | | |
| guard, guarding, against hazards | 0.2.5, 2.1.1.1, 2.1.2, 2.1.3, 2.8.3, 3.3.8, 3.4.4, 3.4.10, 4.4.1 | | |
| | <i>see also</i> cord guard | | |
| H | | | |
| hand, human | <i>see</i> body, human | | |
| HAND-HELD EQUIPMENT | 0.1, 1.2.3.2*, 3.2.8, 3.2.9 | | |
| maximum RATED VOLTAGE 250 V | 1.6.3 | | |
| mechanical strength | 4.2.6 | | |
| power supply cord | 3.2.5.1 | | |
| TOUCH CURRENT | 5.1.6 (Table 5A) | | |
| handles and levers | 4.3.2 | | |
| conductive | 2.1.1.6 | | |
| no mechanical strength test | 4.2.1 | | |
| part of BODY | 1.2.7.5 | | |
| shaft of | 2.1.1.6 | | |
| temperature | 4.5.4 (Table 4C) | | |
| hazard | Clause 0 | | |
| | | access using a TOOL | 1.7.2.5 |
| | | acoustic | 0.2.6 |
| | | basis of design | 0.1, 1.3.2 |
| | | energy | <i>see</i> energy hazard |
| | | fire | <i>see</i> fire hazard |
| | | information to the USER | 1.7.2 |
| | | mechanical | <i>see</i> mechanical hazard |
| | | none after mechanical strength test | 4.2.1, 5.3.9.2 |
| | | SERVICE PERSON aware of | 0.1, 1.2.13.5 |
| | | HAZARDOUS ENERGY LEVEL | 1.2.6.4, 1.2.8.10* |
| | | determination of accessibility | 2.1.1.8, 2.1.1.5 b) |
| | | determination of existence | 2.1.1.5 c), d), and e) |
| | | | <i>see also</i> energy hazard |
| | | HAZARDOUS VOLTAGE | 0.2.1, 1.2.8.6* |
| | | multiple sources | <i>see</i> multiple power sources |
| | | not to be accessible | 2.1.1.1 |
| | | after mechanical strength test | 4.2.1, 5.3.9.2 |
| | | at an appliance inlet | 3.2.4 |
| | | at a connector | 3.1.9, 3.2.2 |
| | | in an OPERATOR ACCESS AREA | 2.1 |
| | | in a RESTRICTED ACCESS LOCATION | 2.1.3 |
| | | in a SERVICE ACCESS AREA | 2.1.2 |
| | | on a thermoplastic part | 4.5.5 |
| | | protection by earthing | 2.6.1, 2.9.4 e), 6.1.1, 7.2 |
| | | separation from | 2.9.4 |
| | | ELV CIRCUIT | 1.2.8.7 |
| | | FUNCTIONAL EARTHING circuit | 2.6.2 |
| | | SELV CIRCUIT | 2.1.2, 2.2.3, 2.2.4 |
| | | TNV CIRCUIT | 2.1.2, 2.3.3, 2.3.4 |
| | | warning notice | 1.7.9, 2.7.6 |
| | | heat | |
| | | ceramic printed board curing temperature | 2.10.6.4 (Table 2R) |
| | | hazard | 0.2.4 |
| | | shock test on winding wire | U.2.3 |
| | | sink | 4.5.4, B.2 |
| | | | <i>see also</i> fire hazard |
| | | heating | 4.5 |
| | | maximum, during a transformer test | Annex X |
| | | heating element | 4.3.7 |
| | | hiccup mode | 2.2.3 |
| | | high voltage component | 4.7.3.6 |
| | | hot flaming oil test | 4.6.2, A.3 |
| | | hot wire ignitability test (IEC 60695-2-20) | 4.7.3.2 |
| | | human body | <i>see</i> body, human |
| | | humidity | 2.9.1 |
| | | additional requirements if humidity is high | 1.1.2 |
| | | conditioning (treatment) | 1.5.6, 1.5.7.2, 2.9.2 , 2.10.8.3, 2.10.10, 2.10.11 |
| | | relative (r.h.) during a test | 4.2.7 (note), 4.6.5, U.2, Y.1 |
| | | hygroscopic material, not to be used as insulation | 2.9.1 |
| | | I | |
| | | ICRP 60 | Annex H (note 1), Bib |
| | | IEC 60065 | 1.1.1 (note 3), 2.1.1.9, 4.2.8, 4.5.1, 4.7.3.6, 5.3.6, N.2, Annex P |
| | | IEC 60068-2-78 | 1.5.7.2, Annex P |

| | | | |
|------------------|--|---|--|
| IEC 60073 | 1.7.8.2, Annex P | IEC 60825-2 | 4.3.13.5, Annex P |
| IEC 60083 | 1.7.5, 2.1.1.1, 2.10.3.1, 2.10.4.3, 4.3.5, G.6, Annex P | IEC 60825-9 | 4.3.13.4, Annex P |
| IEC 60085 | 4.5.3 (Table 4B/Footnote c), 5.3.9.1 (Table 5D), B.3 (Table B.1), B.4 (Table B.2), C.1 (Table C.1), Annex P, U.2.3 (Table U.2) | IEC 60825-12 | 4.3.13.5, Annex P |
| IEC 60112 | 2.10.4.2, Annex P | IEC 60851-3 | Annex P, U.2.2 |
| IEC 60127 | 2.7.3 (note), Bib | IEC 60851-5 | Annex P, U.2.1, U.2.4 (note), U.3.2 |
| IEC 60216-4-1 | 4.2.7, Annex P | IEC 60851-6 | Annex P, U.2.3 |
| IEC 60227 | 3.2.5.1, Annex P | IEC 60885-1 | 3.1.4, Annex P |
| IEC 60245 | 3.2.5.1, Annex P | IEC 60896-21 | 4.3.8, Bib |
| IEC 60269-2-1 | 6.3 (note 4), Bib | IEC 60906-1 | 2.1.1.1, 2.10.3.1, 2.10.4.3, G.6 |
| IEC 60309 | 1.2.5.2, 2.1.1.1, 2.10.3.1, 2.10.4.3, 3.2.4, G.6, Annex P | IEC 60906-2 | 2.1.1.1, 2.10.3.1, 2.10.4.3, G.6 |
| IEC 60317 series | 2.10.5.13, Annex P | IEC 60947-1 | 3.4.2, Annex P |
| IEC 60317-43 | U.2.2 (Table U.1), Annex P | IEC 60950, part 21 | Foreword |
| IEC 60320 | 3.2.5.1 (Table 3B/Footnote b, c, and note1), 4.3.5, G.6, Annex P | IEC 60990 | 5.1.2.1 (note), 5.1.3, 5.1.4 (note 2), D.1, Annex P |
| IEC 60364-1 | Annex P, V.1 | IEC 61032 | 2.1.1.1 (Figure 2A/note 3 and Figure 2B/note), Bib |
| IEC 60364-4-41 | Annex P, V.1 | IEC 61032-1 | 2.1.1.1, 2.10.3.1, 2.10.4.3, 3.2.4, Annex P, Annex Q |
| IEC 60364-7-707 | 5.1.7.1 (note), Bib | IEC 61058-1 | 2.8.7, Annex P |
| IEC 60384-14 | 1.5.6, 1.5.8, Annex P | IEC 61140 | 1.2.8.8 (note 2), Bib |
| IEC 60410 | R.1, R.2, Bib | IEC 61558-1 | Annex AA, Bib |
| IEC 60417-1 | 1.7.1, 1.7.7.1, 1.7.8.3, 2.6.2, 2.6.5.1, 2.7.6, 4.5.4 (Table 4C/Footnotes a and c), Annex P | IEC 61643-21 | 1.5.9.1 (note 2), Bib |
| IEC 60529 | Annex T, Bib | IEC 61643-311 | 1.5.9.1 (note 2), Bib |
| IEC 60664-1 | 1.5.9.2 (note 1), 2.10.1 (note), 2.10.3.1, 5.2.2 (note 2), Clause 6 (note 4), 7.1 (note 4), G.6, Annex P, Annex Z | IEC 61643-321 | 1.5.9.1 (note 2), Bib |
| IEC 60664-4 | 2.10.1.1 (note), Bib | IEC 61643-331 | 1.5.9.1 (note 2), Bib |
| IEC 60695-2-2 | 4.6.2, 4.7.3.6, A.2.7, Annex P | IEC 61965 | 4.2.8 (note), Bib |
| IEC 60695-2-11 | 4.7.3.1, Annex P | IEC Guide 112 | 1.1.1 (note 3), Bib |
| IEC 60695-2-20 | 4.7.3.2, Annex P | IEV (International Electrotechnical Vocabulary) | 2.10.6.4 (Table 2R/note 2), Bib |
| IEC 60695-10-2 | 4.5.5, Annex P | ignition | 0.2.3, 0.2.4, 4.3.12, 4.6.4, 4.7, B.6.3, B.7.3 |
| IEC 60695-11-3 | A.1.4, Annex P | <i>see also</i> FIRE ENCLOSURE | |
| IEC 60695-11-4 | A.2.4, Annex P | impact test | 4.2.1, 4.2.5, 4.3.13.3 (Table 4A) |
| IEC 60695-11-10 | 1.2.12.1, 1.2.12.2, 1.2.12.3, 1.2.12.4, 1.2.12.10, 1.2.12.11, Annex P | implosion of cathode ray tube | 0.2.5, 4.2.8 |
| IEC 60695-11-20 | 1.2.12.1, 1.2.12.5, 1.2.12.6, Annex P | impulse test | 2.10.3.9, 6.2.2.1, 6.2.2.2, 6.2.2.3, 7.4.3, G.5, R.2 (Table R.2/Footnote b), Annex S |
| IEC 60728-11 | 7.1 (note 5), Bib | test generators | Annex N |
| IEC 60730-1 | 2.5, Annex P | indicator, indicating devices | |
| IEC 60747-5 | 2.10.5.4, Annex P | colour | 1.7.8.2, Annex P (IEC 60073, ISO 3864) |
| IEC 60747-5-1 | 2.10.5.4, Annex P | exempt from mechanical strength requirement | 4.2.1 |
| IEC 60747-5-2 | 2.10.5.4, Annex P | lamp exempt from flammability requirements | 4.7.3.3, 4.7.3.4 |
| IEC 60747-5-3 | 2.10.5.4, Annex P | marking | 1.7.8 |
| IEC 60825-1 | 4.3.13.5, Annex P | information technology equipment | |
| | | connection | 1.2.11.6 |
| | | to a CABLE DISTRIBUTION SYSTEM | Clause 7 |
| | | to a TELECOMMUNICATION NETWORK | Clause 6, W.2 |
| | | examples in Scope of this standard | 1.1.1 |
| | | informative reference | Bib |
| | | ingress of water <i>see</i> water ingress | |

| | | | |
|---|---|---|--|
| ink | 4.3.12 | internal wiring | 2.1.1.3, 2.1.1.4, 2.6.2, 3.1.1, 3.1.3, 3.1.4, 3.1.10, 3.3.2, 3.3.6, 4.3.9, 4.7.3.3, 4.7.3.4, C.2 |
| ink tube | 4.7.3.3, 4.7.3.4 | INTERCONNECTING CABLE, treated as internal wiring | 1.5.5 |
| inlet bushing, power cord | 3.2.7 | interpolation | |
| installation, building | see building installation | conditional | 2.10.3.3 (Tables 2K and 2L) |
| installation category | see overvoltage category | permitted in | |
| <i>Note - the term overvoltage category has replaced the term installation category</i> | | electric strength test voltages | 5.2.2 (Tables 5B and 5C) |
| installation instructions | 1.7.1, 1.7.2, 1.7.4, 2.1.1.1 | IEC 60664-1 Table A.2 | 2.10.3.1, G.6 |
| disconnect device | 1.7.2.2, 3.4.3, 3.4.6, 3.4.7, 3.4.9 | insulation spacings | 2.10.3.1 (Tables 2M, 2N, 2Q) and G.6 (Table G2) |
| orientation | 1.3.6 | time for thermal ageing | 2.10.8.2 (Figure 2J) |
| ozone emission | 1.7.2.6 | not permitted in | |
| physical | 4.1, 4.2.10, Annex T | insulation spacings | 2.10.3.3 (Tables 2K and 2L) |
| PLUGGABLE EQUIPMENT | 1.7.2.3 | MAINS TRANSIENT VOLTAGE | G.2 (Table G.1/Footnote b) |
| RESTRICTED ACCESS LOCATION | 1.7.14 | ionizing radiation | 0.2.6, 4.3.13.2, Annex H |
| wiring | | ISDN (Integrated Services Digital Network) | 1.2.13.8 (note 3) |
| earthing | 1.5.9.4, 2.3.2.3, 3.2.1.2, 3.3.7, 5.1.8.2, 6.1.1, 6.1.2.2, 7.2, 7.4.1 | ISO 178 | 4.3.13.3 (Table 4A), Annex P |
| power | 1.7.2.4, 1.7.7.2, 2.7.1, G.2.1 | ISO 179 | 4.3.13.3 (Table 4A), Annex P |
| telecommunication | 6.3 | ISO 180 | 4.3.13.3 (Table 4A), Annex P |
| instructions | 0.1, 1.7.2, 2.6.5.6 | ISO 261 | 3.3.3, Annex P |
| language | 1.7.2.1 (note 3) | ISO 262 | 3.3.3, Annex P |
| removal of all power | 3.4.10, 3.4.11 | ISO 527 | 4.3.13.3 (Table 4A), Annex P |
| see also installation instructions, operating instructions and servicing instructions | | ISO 2859-1 | R.1, R.2, Bib |
| insulation (electrical) | 0.2.1, 1.2.9*, 2.9 | ISO 3864 | 1.7.2.5, 2.7.6, Annex P |
| application | 2.9.1, 2.9.3 | ISO 4046 | 1.2.13.16, Annex P |
| BASIC | see BASIC INSULATION | ISO 4892 | Y.3, Y.4, Annex P |
| better grade may be necessary | 2.9.3 | ISO 7000 | 1.7.1, Annex P |
| better grade permitted | 1.3.5 | ISO 8256 | 4.3.13.3 (Table 4A), Annex P |
| bridging | see bridging of insulation | ISO 9772 | 1.2.12.1, 1.2.12.7, 1.2.12.8, 1.2.12.9, Annex P |
| classification | 4.5.3 (Table 4B) | ISO 9773 | 1.2.12.1, 1.2.12.12, 1.2.12.13, 1.2.12.14, Annex P |
| colour | see colours | isolation (from the supply) | see disconnection for servicing |
| compliance checked by inspection of relevant data | 1.4.15 | IT power distribution system | 1.6.1, V.4 |
| dimensions | 2.10 | heating element | 4.3.7 a) |
| DOUBLE | see DOUBLE INSULATION | marking of equipment | 1.7.2.4 |
| fault, simulated | 1.4.14 | primary power isolation | |
| for more than one requirement | Clause 6 (note 3) | single phase | 3.4.6 (note) |
| FUNCTIONAL | see FUNCTIONAL INSULATION | three phase | 3.4.7 |
| operational | see FUNCTIONAL INSULATION | protective device | 2.7.4 (tables) |
| printed board | see printed board | TOUCH CURRENT | 5.1.3 |
| REINFORCED | see REINFORCED INSULATION | voltage rating of component | 1.5.8 |
| separate testing | see separate testing | ITE | see information technology equipment |
| solid | see solid insulation | ITU-T Recommendation K.11 | Clause 6 (note 1), Bib |
| see also distance through insulation | | ITU-T Recommendation K.20 | 7.1 (note 2), Bib |
| SUPPLEMENTARY | see SUPPLEMENTARY INSULATION | ITU-T Recommendation K.21 | 7.1 (note 2), Bib |
| with varying dimensions | 2.10.1.5, 5.2.2 | ITU-T Recommendation K.27 | 1.2.8.2 (note), 2.10.3.2 b) (note 3), G.2.2 (note), Bib |
| integrity of protective earthing and bonding | 2.6.5 | ITU-T Recommendation K.44 | 7.1 (note 2), Bib |
| INTERCONNECTING CABLE | | ITU-T Recommendation K.45 | Annex N, Annex P |
| 1.2.11.6*, 1.5.5, 3.1.1, 3.5.1 (note 2), 3.5.4 (note) | | K | |
| part of a PRIMARY CIRCUIT | 1.2.8.4 (note) | knobs | see handles and levers |
| part of a SECONDARY CIRCUIT | 1.2.8.5 (note) | | |
| part of a TNV CIRCUIT | 1.2.8.11 (note 2) | | |
| interconnection of equipment | 1.1.1, 1.7.2.1 (note 1), 2.6.5.1, 3.4.10, 3.5, 5.1.2.1, W.2 | | |
| see also connections | | | |
| interleaved insulation in wound components | 2.10.5.11, 2.10.5.14, Annex U | | |
| interlock | see SAFETY INTERLOCK | | |

L

label *see* warning notice

lamps

- high pressure 0.2.5, **4.2.9**
 - left in place during a test 2.1.1.1
 - no flammability requirement 4.7.3.3, 4.7.3.4
 - UV type 4.3.13.3, 4.3.13.4
- see also* starting pulses

languages for instructions and marking 1.7.2.1 (note 3)

laser radiation (including LEDs)

0.2.6, **4.3.13.5**, Annex P (IEC 60825 series)leakage current 1.2.13.12 (note), 1.2.13.13 (note),
1.5.9.2 (*and* note 2), 5.1.7.1 b), 5.1.8.2 a), W.1.2*see also* TOUCH CURRENTLED (light emitting diode) *see* laser radiationlegal requirements 1.1.2 (note), Clause 6 (note 2),
3.2.1.2 (note), 7.1 (note 3)*see also* country noteslevers *see* handles and leverslightning *see* transientslimit *see* EXPLOSION LIMIT *and* maximum

LIMITED CURRENT CIRCUIT

1.2.8.9*, 1.5.6, 1.5.9.2, **2.4**, 2.10.1.7

- connection to other equipment 3.5.2, 6.2.1
- in an OPERATOR ACCESS AREA 1.5.7.2, 2.1.1

limited power source **2.5**, 4.7.2.1, 4.7.2.2LIMITER, TEMPERATURE *see* TEMPERATURE LIMITER

liquid

- conductive **1.3.9**, 4.3.8, 4.3.10
- container 4.7.3.4
- under pressure 4.3.11
- flammable 0.2.3, 0.2.4, 4.3.10, **4.3.12**, 4.5.3 (Table 4B)
- parts in contact 4.5.3 (Table 4B)

loosening *see* fixing

louvre 4.6.1

see also opening in an ENCLOSURE

M

mains

as communication transmission medium

1.1.1, Clause 6 (note 4), 7.1 (note 4)

not a CABLE DISTRIBUTION SYSTEM 1.2.13.14

not a TELECOMMUNICATION NETWORK 1.2.13.8

capacitor 1.5.6, 1.5.8, 2.1.1.7, 2.1.1.8

frequency 1.4.6, 1.4.7, 1.7.1

isolation from *see* disconnection

plug 1.2.3.6, 3.2.1.1, 3.2.1.2

design and selection 2.6.5.4, 3.2.2, 4.3.5, 4.3.6

disconnect device 1.7.2.2, 3.4.2, 3.4.9

voltage 1.4.5, 1.5.8, 1.6.4, 1.7.1, 2.10.3.1,
G.2.1 (Table G.1)

adjustment 1.7.4, 4.3.3

d.c. 1.7.1, 5.2.2 (Table 5B/part 2/Footnotes a, b, c *and* d)

line to neutral

1.7.1, 2.10.3.2 (Table 2J), G.2.1 (Table G.1)

see also AC MAINS SUPPLY, DC MAINS SUPPLY, DIRECT
PLUG-IN EQUIPMENT, PRIMARY CIRCUIT *and* wiring
terminals

MAINS SUPPLY 1.2.8.3*

see also AC MAINS SUPPLY *and* DC MAINS SUPPLYMAINS TRANSIENT VOLTAGE 1.2.9.10*, 1.4.8, 1.5.6 (Table 1D),
2.10.3.2, 2.10.3.3 (Tables 2K *and* 2L),
2.10.3.7 (note 2), **G.2**, G.4.1

related to overvoltage category

2.10.3.2 (Table 2J), G.2.1 (Table G.1)

reduced level in SECONDARY CIRCUIT

2.10.3.4

measurement 2.10.3.9, G.1.2, G.4, G.5

see also transients

mandrel

for wire testing

U.2.2, U.2.3, U.2.4

test

Annex AA

markings

0.1, 1.7, 2.1.1.2

additional marking requirements *see* 1.7 (note)

durability

1.7.11

t-marking

4.5.3 (Table 4B)

see also warning notices

mass

of equipment

marking and test not on bottom if over 18 kg 1.7.1, 4.2.4

movable equipment 1.2.3.1

parameter for requirements and tests

2.1.1.1, 3.2.5.1, 3.2.6, 4.1, 4.2.6, 4.7.3.2, A.1, A.2

of steel ball in impact test

4.2.5

material group *see* tracking

materials

must be reliable

0.3

not covered in this standard

1.3.4

use of better materials permitted

1.3.5

see also insulation *and* separate testing

maximum,

amount of flammable liquid

4.3.12

current to telecommunication wiring

6.3

input current

1.6.2

ionizing radiation *see* ionizing radiation

LIMITED CURRENT CIRCUIT levels

2.4.2

limited power source output

2.5

normal load (mode of operation)

1.2.2.1

output load

1.7.5

overvoltage, assumed in this standard

Clause 6 (note 1), 7.1 (note 2)

see also overvoltage category

ozone level

1.7.2.6

power from TELECOMMUNICATION NETWORK 15 VA

1.4.11

RATED OPERATING TIME

1.2.2.2

RATED VOLTAGE

250 V for HAND-HELD EQUIPMENT

1.6.3

600 V in Scope of this standard

1.1.1

ringing signal level

M.2, M.3

ripple, *see* ripple

SELV CIRCUIT voltages

normal

2.2.2

fault condition

2.2.3

temperature

1.4.12, 1.4.13, 4.5.3, 4.5.4

in an OPERATOR ACCESS AREA

4.5.4 (Table 4C)

| | |
|---|--|
| of | |
| conductor | 3.1.1 |
| insulation during a test | 5.3.9.1 |
| materials and components | 0.2.4, 4.5.3 (Table 4B) |
| motor | B.3 , B.4, B.5, B.7.2, B.8, B.9 |
| transformer | C.1, Annex X |
| winding | 1.4.13, Annex E |
| TNV CIRCUIT voltages | |
| TNV-1 CIRCUIT | 2.3.1 a) |
| TNV-2 and TNV-3 CIRCUITS | 2.3.1 b) |
| TOUCH CURRENT | 5.1.1, 5.1.6, 5.1.8.1, 5.1.8.2 |
| transient voltage | see transients |
| ultraviolet radiation | 4.3.13.4 |
| measuring instrument, electrical | |
| ammeter, negligible impedance | 1.4.7 , 1.4.9, 2.1.1.7, 2.4.2, 5.1, Annex D 5.1.7.1 a) |
| MECHANICAL ENCLOSURE | |
| see ENCLOSURE and opening in an ENCLOSURE | |
| mechanical hazard | 0.2.5, 2.8.2, 4.1 |
| mechanical shock | |
| affecting CLEARANCE | 0.1 |
| affecting a SAFETY INTERLOCK | 2.8.3 |
| mechanical strength | 4.2 |
| after ultraviolet radiation | 4.3.13.3 |
| cathode ray tube | 0.2.5, 4.2.8 |
| handles (no test) | 4.2.1 |
| high pressure lamp | 4.2.9 |
| in a SAFETY INTERLOCK | 2.8.5, 2.8.8 |
| insulating materials | 2.9.1 |
| no test in a MECHANICAL ENCLOSURE | 4.2.1 |
| screws | 3.3.3 |
| mechanical stress, on insulation | 2.10.5.12, 3.2.7, 5.2.2 |
| mechanically operated part | |
| in a SAFETY INTERLOCK system | 2.8.4, 2.8.5 |
| mechanically operated switch in a SAFETY INTERLOCK system | 2.8.7 |
| metal | |
| core in printed board | 2.10.6.4, 2.10.8.4 |
| foil | see foil, conductive |
| molten | 0.2.2, 4.3.8, 4.6.2, 4.6.4.2, 5.3.9.1 |
| screen | see screen, conductive |
| metal, no flammability test | 4.7 |
| metal oxide varistor | 1.5.9.1 (note 1) |
| misuse, foreseeable | 0.1, 5.3.1 |
| mobility of equipment (definitions) | 1.2.3* |
| moisture | see humidity and water ingress |
| motor | |
| requirements | 4.7.2.2, 5.3.2 |
| tests | Annex B |
| motor-generator sets, not in Scope of this standard | 1.1.3 |
| MOVABLE EQUIPMENT | 0.1, 1.2.3.1*, 1.2.3.2, 1.2.3.3, 1.2.3.4, 4.2.6, 5.1.6 (Table 5A) |
| FIRE ENCLOSURE | 4.7.3.2, A.1, A.2 |
| power supply cord flexing test | 3.2.5.1 |
| movable part of equipment | |
| 1.4.4, 2.1.1.1, 2.10.3.1, 2.10.4.3, G.6 | |
| see also removable part | |

| | |
|-------------------------|--|
| moving part of | |
| equipment | 0.2.5, 2.8.2, 3.1.2, 4.2.1, 4.4 |
| SAFETY INTERLOCK system | 2.8.4, 2.8.5 |
| multiple power sources | 1.7.9, 2.6.4.2, 3.2.2, 3.4.10, 3.4.11 , 5.1.2.2, 5.1.2.3, 5.1.7.1, 5.1.7.2 |

N

| | |
|--|--|
| national requirements | see country notes and legal requirements |
| network | see TELECOMMUNICATION NETWORK |
| neutral conductor | 1.6.4 |
| disconnection by disconnect device | 3.4.6, 3.4.7 |
| disconnection by protective device | 2.7.4, 4.3.7 |
| earthed and reliably identified | 2.7.4, 3.4.6 |
| fuse in neutral, warning required | 2.7.6 |
| in power distribution system | Annex V |
| marking of terminals | 1.7.7.2 |
| noise hazard (acoustic) | 0.2.6 |
| <i>Note - there is no requirement in this standard for protection against acoustic noise</i> | |
| nominal AC MAINS SUPPLY voltages | 2.1.1.7, 2.10.3.2 (Table 2J), 6.1.2.1, G.1.2, G.2.1 (Table G.1) |
| NON-DETACHABLE POWER SUPPLY CORD | |
| see power supply cord | |
| NORMAL LOAD condition | 1.2.2.1*, 1.6.2, 4.5.2, Annex L |
| normative references | Annex P |
| number changes in this edition of the standard | Annex BB |

O

| | |
|---|---|
| oil and grease | 4.3.9 , 4.3.12 |
| hot flaming oil test | A.3 |
| see also liquids | |
| opening in an ENCLOSURE | 4.6 |
| access to | |
| electrical hazard | 2.1.1.1, 2.1.1.2, 2.8.2 |
| mechanical hazard | 2.8.2, 4.4.2 |
| ultraviolet radiation | 2.8.2, 4.3.13.4 |
| component which fills | 4.7.2.2, 4.7.3.2 |
| for power cord | 3.2.7, 3.2.8 |
| in bottom of an ENCLOSURE | 4.6.2 |
| in top and sides of an ENCLOSURE | 4.6.1 |
| in TRANSPORTABLE EQUIPMENT | 4.6.4 |
| measuring through | 2.10.3.1, 2.10.4.3 Annex F (Figure F.12), G.6 |
| ventilation, in FIRE ENCLOSURE | 4.7.3.3, 4.7.3.4, A.1.1, A.1.5, A.2.1, A.2.5 |
| operating conditions (definitions) | 1.2.2* |
| operating instructions | 1.2.7.1, 1.2.7.3, 1.3.6, 1.4.4, 1.7.2.1, 1.7.2.6, 1.7.13, 2.1.1.2, 3.4.10, 3.4.11, 4.2.5, 4.3.12, 4.3.13.4, 4.3.13.5, 4.4.2, 4.6.3, L.7 |
| OPERATION, CONTINUOUS | |
| see CONTINUOUS OPERATION | |
| operational insulation | see FUNCTIONAL INSULATION |
| <i>Note - the term FUNCTIONAL INSULATION has replaced the term operational insulation</i> | |

OPERATOR *see* USER, *which has the same meaning*

| | |
|---|--|
| OPERATOR ACCESS AREA | 0.1, 1.2.7.1*, 2.1 |
| access probes | 2.1.1.1 |
| compared with a RESTRICTED ACCESS LOCATION | 1.2.7.3 (note), 2.1.3 |
| door in FIRE ENCLOSURE | 4.6.3 |
| power rating marking to be visible | 1.7.1 |
| TOOL required for access | 1.2.7.1, 1.7.2.5 |
| ordinary NON-DETACHABLE POWER SUPPLY CORD | 1.2.5.6* |
| <i>see also</i> power supply cord | |
| orientation (attitude) | 0.1, 1.3.6, 4.1, 4.2.5, 4.6.1, 4.6.2 |
| overcurrent and earth fault protection | 0.2.3, 2.7 , 3.1.1, 5.3.1, 6.3, Annex P (ITU-T Rec. K.44) |
| location | 2.7.1, 2.7.4 |
| not allowed in protective conductor | 2.6.5.2 |
| performance | 2.5 (Table 2C/Footnote e) |
| protection for telecommunication wiring | 6.3 |
| protection for transformers | 5.3.3, C.1, Annex X |
| protective device | |
| in limited power source | 2.5 |
| in neutral conductor | 2.7.6 |
| minimum number of poles | 2.7.4 |
| not allowed to operate during test | 4.5.2 |
| not to be damaged during a test | 4.2.1 |
| rating to be specified for PLUGGABLE EQUIPMENT | 1.7.2.3 |
| unexpected restart | 4.4.1 |
| <i>see also</i> circuit-breaker and fuse | |
| overriding a SAFETY INTERLOCK | 2.8.6 |
| overheating of telecommunication wiring | 6.3 |
| overload | |
| mechanical | 5.3.1 |
| motor | 5.3.2 , B.4 (Table B.2), B.5, B.6, B.7 |
| test | 2.8.7.2 , 5.3.7, 5.3.9.1 (Table 5D) |
| transformer | 5.3.3, C.1, Annex X |
| <i>see also</i> overcurrent | |
| overvoltage | 0.1, Annex P (ITU-T Rec.K.44), Bib (ITU-T Rec. K.11, K.20, K.21, K.45) |
| maximum level assumed in this standard | Clause 6 (note 1), 7.1 (note 2) |
| not considered | 1.2.9.6, 1.4.8 |
| on a TNV CIRCUIT | 1.2.8.11 (Table 1A), 1.2.8.12, 1.2.8.13, 1.2.8.14, 2.2.2 (note 1) |
| on a TELECOMMUNICATION NETWORK, <i>see</i> TELECOMMUNICATION NETWORK TRANSIENT VOLTAGE | |
| <i>see also</i> overvoltage category and transients | |
| overvoltage category | 1.5.6 (Table 1D), 2.10.3.1, 2.10.3.2, 3.4.2, G.1.1, G.2.1, Annex Z |
| categories III and IV | G.1.1, G.2.1 |
| <i>Note - the term</i> overvoltage category <i>has replaced the term</i> installation category | |
| ozone | 1.7.2.6 |
| P | |
| Part 68, FCC Rule | M.3 (note), Bib |
| passive devices (requiring no power) | |
| not in Scope of this standard | 1.1.3 |
| PEAK WORKING VOLTAGE | 1.2.9.8* |

Note - PEAK WORKING VOLTAGES are used in numerous places in the standard to determine minimum clearances, separation distances and test voltages.

| | |
|--|---|
| PERMANENTLY CONNECTED EQUIPMENT | 1.2.5.4* |
| discharge of capacitor | 2.1.1.7, 2.1.1.8 |
| disconnect device | 3.4.3 |
| earthing | 2.6.4.2, 2.6.4.3, 6.1.2.2, 7.4.1 |
| marking | 1.7.7.2, 1.7.7.3 |
| overcurrent protection | 2.7.1, 2.7.3, 2.7.6 |
| terminals | 3.2.3 , 3.3.1, 3.3.7 |
| TOUCH CURRENT | 5.1.1, 5.1.7.1 |
| permission to connect to a TELECOMMUNICATION NETWORK | <i>see</i> legal requirements |
| person, network service <i>see</i> SERVICE PERSON | |
| PERSON, SERVICE <i>see</i> SERVICE PERSON | |
| plating, protective earthing component | 2.6.5.6 |
| PLUGGABLE EQUIPMENT | 1.2.5.3*, 4.3.7 |
| current rating of protective device to be specified | 1.7.2.3 |
| discharging filter capacitor | 2.1.1.7, 2.1.1.8 |
| earthing | 2.3.2.3 |
| isolation | 3.4.2, 3.4.6 |
| PLUGGABLE EQUIPMENT TYPE A | 1.2.5.1*, 1.2.5.3, 2.6.3.3, 2.6.4.3, 2.7.3, 2.10.3.1, 5.1.6 (Table 5A), 5.1.7.1, 5.1.8.2, 7.4.1, G.6 |
| PLUGGABLE EQUIPMENT TYPE B | 1.2.5.2*, 1.2.5.3, 1.5.9.4, 1.7.2.3, 2.6.3.3, 2.6.4.3, 2.7.1, 2.7.3, 5.1.1, 5.1.7, 5.1.7.1, 6.1.2.2, 7.4.1 |
| plugs <i>see</i> connectors and mains | |
| pollution (degree) | 0.1, 2.9.1, 2.10.1.2 , , 2.10.3.3 (tables), 2.10.4 (Table 2N), 2.10.5.5, Annex F (Table F.1), Annex G (Table G.2) |
| pollution degree 1 applies | 2.10.1.2, 2.10.3.3 (Table 2K/Footnote b and Table 2L/Footnote b), 2.10.3.4 (Table 2M/Footnote b, 2.10.4.3 (Table 2N/ Footnote a), 2.10.5.5 b), 2.10.10, 2.10.12, G.6 (Table G.2/Footnote b) |
| polychloroprene (synthetic rubber) | 4.7.2.2, 4.7.3.3, 4.7.3.4 |
| polyimide insulating material | 4.7.2.2, 4.7.3.3, 4.7.3.4 |
| positive temperature coefficient (PTC) device | 2.5, Annex P (IEC 60730-1) |
| powder | 4.3.10 |
| container | 4.7.3.4 |
| power | |
| apparent | 2.5 (tables) |
| connection to equipment | 1.6, 3.2 |
| from a TELECOMMUNICATION NETWORK 15VA | 1.4.11 |
| limited <i>see</i> limited power source | |
| no power required, excluded from Scope of this standard | 1.1.3 |
| outlet on equipment <i>see</i> socket-outlet on equipment | |
| rating, marking | 1.7.1 , 1.7.4 |
| sources for equipment | |
| any, included in Scope | 1.1.1 |
| multiple <i>see</i> multiple power sources | |
| supplied to telecommunication wiring | 6.3 |
| power distribution system, a.c. | 1.2.8.1, 1.2.8.3, 1.6.1, Annex V |
| single phase, three wire | V.2 (Figure V.4) |
| <i>see also</i> IT power distribution system, TN power distribution system and TT power distribution system | |

| | | | |
|--|--|--|---|
| power distribution system, d.c. | 1.2.8.2, 1.2.8.3 | functional earthing | 2.6.2 |
| power supply cord | 3.2.1.1, 3.2.1.2, 3.2.5.1, 3.2.5.2 | integrity to be assured | 2.6.5 |
| DETACHABLE POWER SUPPLY CORD | 1.2.5.5*, 2.6.4.2, 3.2 | resistance | 2.6.3.4 |
| inside the equipment | 3.1.4 | separation from PROTECTIVE EARTHING CONDUCTOR | 2.6.4.3 |
| marking of wiring terminals | 1.7.7 | size | 2.6.3.3, 3.2.5 (Table 3B) |
| NON-DETACHABLE POWER SUPPLY CORD | 1.2.5.6*, 2.6.4.3, 2.10.3.1, 2.10.4.3, 3.2, 3.3, 4.5.3 (Table 4B), G.6 | terminals | 1.7.7.1, 2.6.4.2, 3.3.5 |
| PROTECTIVE EARTHING CONDUCTOR | 2.6.3.2, 3.2.6 | PROTECTIVE CONDUCTOR CURRENT | 1.2.13.13*, 5.1.1, 5.1.6, 5.1.7.1 a), Annex P (IEC 60990) |
| colour of insulation | 2.6.3.5 | protective covering in place during a test | 5.3.1 |
| voltage drop not measured | 1.4.9, 2.6.3.4 | PROTECTIVE CURRENT RATING | 1.2.13.17*, 2.6.3.3 , 2.6.3.4 |
| screened | 3.2.5.1 | protective device | see overcurrent and earth fault protection |
| pre-preg | 2.10.5.5, 2.10.6.4 (Table 2R) | protective earthing and bonding | 2.6 |
| meaning of "pre-preg" | 2.10.6.4 (Table 2R/note 2) | PROTECTIVE EARTHING CONDUCTOR | 1.2.13.10*, 2.6.3 |
| preselection of materials | see separate testing | colour of insulation | 2.6.3.5 |
| PRIMARY CIRCUIT | 1.2.8.4*, 1.2.8.5 | components not allowed in | 2.6.5.2 |
| capacitors in | 1.5.6, 2.1.1.7, 2.1.1.8 | in power supply cord | 3.2.5.1, 3.2.6 |
| CLEARANCE in | 2.10.3.3, Annex G | integrity to be assured | 2.3.2.3, 2.6.5 , 5.1.7.1, 5.1.8.2 a), 6.1.1, 6.1.2.2, 7.2 |
| faults in components in | 5.3.7 | resistance | 2.6.3.4 |
| filter in | 0.2.1, 5.1 | separation from PROTECTIVE BONDING CONDUCTOR | 2.6.4.3 |
| internal wiring | 3.1.1 | size | 2.6.3.2, 3.2.5 (Table 3B) |
| marking of switch | 1.7.8 | terminal | 1.7.7.1, 2.3.2.3, 2.6.4.2, 3.3.5 |
| marking of terminals | 1.7.7 | tests, not included | 5.1.2.3 |
| protection | 2.7 | voltage drop not measured | 1.4.9, 2.6.3.4 |
| SAFETY INTERLOCK switch, contact gap | 2.8.7.1, 2.8.7.4 | see also PLUGGABLE EQUIPMENT TYPE B | |
| surge suppressor must be a VDR | 1.5.9.1, Annex Q | PTC | see positive temperature coefficient device |
| transients | 2.10.3.6 | PTFE (polytetrafluoro ethylene) | 4.7.2.2, 4.7.3.3, 4.7.3.4 |
| WORKING VOLTAGE in | 2.10.2.1 | PTI (proof tracking index) | see tracking |
| see also mains | | PVC (polyvinyl chloride) | 3.2.5.1, 4.5.3 (Table 4B), 4.7.2.2, 4.7.3.3, 4.7.3.4, Annex P (IEC 60227) |
| primary power | | Q | |
| see AC MAINS SUPPLY, DC MAINS SUPPLY and PRIMARY CIRCUIT | | quality control | 2.10.3.3 (Table 2K), 2.10.3.4 (Table 2M), 2.10.6.2, 2.10.7, G.6 (Table G.2) |
| principles of safety | Clause 0 | quality control programme | Annex R |
| printed boards | 2.10.6 | R | |
| clearance and creepage distance, uncoated | 2.10.6.1 | radiation | 4.3.13 |
| coated | 2.10.6.2 | hazards | 0.2.6 |
| distance through insulation | 2.10.5.2 | ionizing | see ionizing radiation |
| metal core | 2.10.6.4, 2.10.8.4 | laser | see laser radiation |
| multi-layer | 2.10.6.3 | ultraviolet | see ultraviolet radiation |
| quality control | R.1 | range | |
| printed wiring, colour of flexible | 2.6.3.5 | current marking | 1.7.1 |
| see also printed boards | | frequency | see RATED FREQUENCY RANGE |
| proof tracking index (PTI) | see tracking | of conductor size | 3.3.4, 3.3.5 |
| protection | | voltage | see RATED VOLTAGE RANGE |
| against electric shock and energy hazards | 2.1, Clause 6, Clause 7 | RATED CURRENT (of equipment) | 1.2.1.3* |
| against ingress of water | see water ingress | input current not to exceed | 1.6.2 |
| against moving parts of equipment | see moving parts of equipment | marking | 1.7.1 |
| against overcurrent and earth faults | 2.7 | power supply cord current carrying capacity | 2.6.3.2, 3.2.5.1 |
| backup protection | 2.7.3 | purpose of marking | 1.7.1 |
| provided by building installation | 2.7.1, 2.7.3 | range | 1.7.1 |
| in an OPERATOR ACCESS AREA | 2.1.1 | terminal sizes | 3.2.3, 3.3.4, 3.3.5 |
| in a RESTRICTED ACCESS LOCATION | 2.1.3 | rated current of overcurrent protective device | |
| in a SERVICE ACCESS AREA | 2.1.2 | | |
| of a cable system equipment USER | 6.2, 7.2, 7.3 | | |
| of a service person | see service person | | |
| of a telecommunication equipment USER | 6.1, 6.2 | | |
| of telecommunication wiring | 6.3 | | |
| PROTECTIVE BONDING CONDUCTOR | 1.2.13.11*, 2.6.3 | | |
| colour of insulation | 2.6.3.5 | | |
| components not allowed in | 2.6.5.2 | | |

| | | | |
|--|---|--|--|
| <i>see</i> fuse and overcurrent and earth fault protection | | removable part | 1.7.12, 2.1.2, 3.2.7, 3.4.2, 4.6.3 |
| RATED FREQUENCY | 1.2.1.4*, 1.4.6, 1.7.1 | REQUIRED WITHSTAND VOLTAGE | 1.2.9.9*, 1.5.7, 2.9.4, 5.2.2, G.1, G.4 , G.6 |
| RATED FREQUENCY RANGE | 1.2.1.5*, 1.4.6, 1.7.1 | requirements of this standard, applicable only if safety is involved | 1.3.1 |
| RATED OPERATING TIME | 1.2.2.1, 1.2.2.2*, 1.2.2.3, 1.7.3, 5.3.8 | resistance, protective conductor | 2.6.3.4 |
| RATED RESTING TIME | 1.2.2.1, 1.2.2.3*, 1.7.3, 5.3.8 | resistance to fire <i>see</i> fire hazard | |
| RATED VOLTAGE of equipment | 1.2.1.1* | resistor test | 1.5.7 |
| IT power distribution system | 1.5.8, V.4 (Figure V.7) | resistors | |
| marking and instructions | 1.7.1, 1.7.4 | bridging <i>see</i> bridging of insulation | |
| maximum value | | faults in | 1.4.14, 5.3.7 |
| 250 V for HAND-HELD EQUIPMENT | 1.6.3 | RESTRICTED ACCESS LOCATION | 0.1, 1.2.7.3*, 2.1.3 |
| 600 V in Scope of this standard | 1.1.1 | bottoms of FIRE ENCLOSURES | 4.6.2 |
| tolerance | 1.4.5 | compared with an OPERATOR ACCESS AREA | |
| used for test | 1.3.3, 1.4.5, 1.6.2, 5.1.3, 6.1.2.1, B.2, G.4, Annex K | installation instructions | 1.2.7.3 (note), 2.1.3 1.7.14, 5.1.7 |
| when determining WORKING VOLTAGE | 2.10.2.1 f) and g) | marking if DC MAINS SUPPLY | 2.1.1.8 |
| when measuring input current | 1.6.2 | maximum temperature, exception for heat sink | 4.5.4 |
| RATED VOLTAGE RANGE of equipment | 1.2.1.2* | mechanical hazard in | 4.4.3 |
| marking | 1.7.1 | r.f.i. (radio frequency interference) | |
| used for test | 1.3.3, 1.4.5, 1.6.2, 5.1.3, 6.1.2.1, B.2, G.4, Annex K | <i>see</i> electrical filter | |
| when determining WORKING VOLTAGE | 2.10.2.1 f) and g) | ringing signal <i>see</i> telephone ringing signal | |
| when measuring input current | 1.6.2 | ripple in DC VOLTAGE | |
| rated voltage of components | 1.6.4 | definition | 1.2.13.4* |
| capacitor | 1.5.6, 1.5.8 | in a limited power source | |
| fuse | 1.7.6 | 2.5 (Table 2B/Footnote a and Table 2C/Footnote a) | |
| motor, used for test | B.6, B.10 | in PEAK WORKING VOLTAGE | 1.2.9.8, 2.10.2.3 |
| surge suppressor | 6.1.2.1 | r.m.s. value implied unless otherwise specified | 1.2 |
| redundant power supply <i>see</i> multiple power sources | | RMS WORKING VOLTAGE | 1.2.9.7*, 1.5.6 (Table 1C), 2.10.2.2 , 2.10.4.1, 2.10.4.3 (Table 2N) |
| reed switch, reliability test | 2.8.7.3 | <i>Note - RMS WORKING VOLTAGES are used in numerous places in the standard to determine minimum CLEARANCES, separation distances and test voltages</i> | |
| REINFORCED INSULATION | 0.2.1, 1.2.9.5* | ROUTINE TEST | 1.2.13.3* |
| application | 2.9.3 | coated printed board | |
| in | | 2.10.6.2, 2.10.6.4 (Table 2R), R.1 (Table R.1) | |
| CABLE DISTRIBUTION SYSTEM | 7.1 (note 4) | electric strength test voltage and duration | 5.2.2 |
| FUNCTIONAL EARTHING circuit | 2.6.2 | reduced CLEARANCE requiring ROUTINE TESTS | |
| internal wiring | 2.1.1.4 | 2.10.3.3 (Table 2K), 2.10.3.4, (Table 2M), 2.10.7, G.6 (Table G.2), R.2 (Table R.2) | |
| manual control | 2.1.1.6 | semiconductor devices | 2.10.5.4 |
| printed board | 2.10.6.4, Annex F (Figure F.11) | solvent-based enamel | 2.10.5.13 |
| SELV CIRCUIT | 2.2.4, 2.9.4 a) and b) | winding wire | U.3.1 |
| TELECOMMUNICATION NETWORK | Clause 6 (note 4) | wound component | 2.10.5.11 |
| TNV CIRCUIT | 2.3.3, 2.3.4, 2.9.4 a) and b) | routing of wiring | 2.1.1.3, 2.1.1.4, 2.9.4 a), 3.1.3 |
| wound component | 2.10.5.11, Annex U | rubber | |
| bridging <i>see</i> bridging of insulation | | as cable insulation | Annex P (IEC 60245) |
| dimensions | 2.10.3 , 2.10.4 , 2.10.5 , Annex F, G.6, R.2 | as insulation | 3.1.9, 3.2.5.1, 4.5.3 (Table 4B) |
| electric strength | 5.2 | natural, not to be used as insulation | 2.9.1 |
| integrity | | parts | 4.5.3 (Table 4B) |
| after a test | 4.2.1, 5.3.4, 5.3.7, 5.3.9.2 | polychloroprene (synthetic rubber) | 4.7.2.2, 4.7.3.3, 4.7.3.4 |
| in service | 3.1.6, 4.3.4, C.2 | roller | 4.7.3.3, 4.7.3.4 |
| protective device not needed | 2.7.4 | touch temperature limits | 4.5.4 (Table 4C) |
| WORKING VOLTAGE | 2.10.2 | running overload tests | |
| relative humidity <i>see</i> humidity | | a.c. motor | B.4 |
| relays | 1.5.1 (notes 2 and 3) | d.c. motor | B.6 |
| in a FIRE ENCLOSURE | 4.7.2.1 | | |
| in a SAFETY INTERLOCK switch or relay, contact gap | 2.8.7.1 | | |
| in a SAFETY INTERLOCK system | 2.8.5 (note), 2.8.7 | | |
| motor starting | B.5 | | |
| reliability <i>see</i> endurance testing | | | |
| remote power feeding (of telecommunication equipment) | | | |
| | Foreword | | |

see also part 21 of this standard, IEC 60950-21

S

| | |
|---|--|
| SAFETY INTERLOCK | 1.2.7.6*, 2.1.1.1, 2.8, 4.3.13.4, 4.4.2 |
| not damaged during a mechanical strength test | 4.2.1 |
| samples for test | |
| components | 1.5.2 |
| equipment | 1.2.13.1, 1.2.13.2, 1.2.13.3, 1.4.3 |
| flammability | A.1.1, A.2.1, A.3.1 |
| SAMPLING TEST | 1.2.13.2*, R.1, R.2, U.3.2 |
| scope of this standard | 1.1 |
| screens | |
| bottom of FIRE ENCLOSURE | 4.6.2, 4.7.3.5 |
| conductive | 2.9.3 (Table 2H) |
| coaxial cable | 7.3 |
| earthed | 0.2.1, 1.4.14, 2.6.1 e), 2.10.3.6, 5.2.2, C.2, G.4.1 b) |
| for an SELV CIRCUIT | 2.2.4, 2.9.4 d) |
| for a TNV CIRCUIT | 2.3.4, 2.9.4 d) |
| for a FUNCTIONAL EARTHING circuit | 2.6.2 |
| in a power supply cord | 3.2.5.1, 3.2.6 |
| unearthed | 5.2.1 |
| mechanical | 4.2.1, 4.6.2, 4.6.4, 4.7.3.5 |
| secured with adhesive | 4.6.5 |
| screws, screw connections | Annex P (ISO 261, ISO 262) |
| for electrical contact | 3.1.6, 3.1.8, 3.1.9 |
| for protective earthing continuity | 2.6.1, 2.6.4.2, 2.6.4.3, 2.6.5.7, 3.3.1, 3.3.3, 3.3.5, 3.3.6, 3.3.8 |
| for securing a part | 4.3.4 |
| into, or made of, insulating material | 3.1.7, 3.2.6, C.2 |
| no marking on | 1.7.7.1, 1.7.7.2, 1.7.7.3 |
| self-tapping and spaced thread | 2.6.5.7, 3.1.8 |
| terminals | 1.2.5.4, 2.6.4.2, 2.6.4.3, 3.1.9, 3.3.1, 3.3.3, 3.3.5, 3.3.6, 3.3.8 |
| sealed, sealing | |
| components | 4.7.3.3, 4.7.3.4 |
| compound | 2.1.1.1 (note 1), 4.3.2, 4.5.2 |
| kit (against moisture) | Annex T |
| layers of insulation tape on winding wire | 2.10.5.12, U.1 |
| liquid reservoir | 4.3.12 |
| SECONDARY CIRCUIT | 1.2.8.2, 1.2.8.5*, 1.2.8.7, 1.2.8.8, 1.2.8.11, 2.8.7.1, 2.9.3 |
| CLEARANCE in | 2.10.3.4, 5.3.4, Annex G |
| FIRE ENCLOSURE | 4.7.2.1, 4.7.2.2, 4.7.3.3 |
| hazardous voltage | 1.5.6 (note 2), 2.1.3, 2.2.4, 2.3.4, 7.2 |
| motor in | 5.3.2, B.1, B.6, B.7 |
| switch in | 1.7.8.3 |
| transients in | 2.10.3, G.4.1 b), G.4.1 c) |
| TNV CIRCUIT | 1.2.8.11 |
| WORKING VOLTAGE | |
| over 10 kV | 5.2.2 (Table 5B/part 1) |
| between a PRIMARY CIRCUIT and a SECONDARY CIRCUIT | 2.10.2.1 |
| secondary winding overload test | C.1, Annex X |
| securing | see fixing |
| SELV CIRCUIT | 1.2.8.8*, 2.2 |
| accessibility | 2.1.1 |
| barrier in | 2.9.4 a) |
| boundary of | 2.2.2 (note 1), 2.2.4 |
| CABLE DISTRIBUTION SYSTEM, excluded from | 1.2.13.14 |
| compared with a TNV CIRCUIT | 1.2.8.11 (Table 1A) |
| connected to a CABLE DISTRIBUTION SYSTEM | 7.2 |

| | |
|--|---|
| connected to a TELECOMMUNICATION NETWORK | 2.2.2 (note 1), 2.10.3.8, 6.1.1 , G.3 |
| connection to other equipment | 3.5.1, 3.5.2, 3.5.4 |
| connection to other circuits | 2.2.4 |
| connectors | 4.3.5 |
| different from the term "SELV system" in IEC 61140 | 1.2.8.8 (note 2) |
| earthing | 2.3.2.3, 2.6.1, 2.9.4 e) |
| faults | 1.2.8.8, 1.4.14, 2.2.1, 2.2.3, 2.3.1, 2.3.2.1 |
| FIRE ENCLOSURE not required | 1.4.11, 4.7.2.2 |
| insulation | 2.9.3 |
| maximum voltages | |
| earthing | 2.6.3.4 |
| fault conditions | 2.2.3 , 2.3.2.1 |
| normal conditions | 1.4.8, 2.2.2 |
| separation | |
| from an accessible part, no requirement | 2.1.1 |
| from a HAZARDOUS VOLTAGE | 2.1.2, 2.2.3 , 2.9.4 |
| from other circuits | 2.9.3 (Table 2H), 3.1.9, 6.2.1 |
| TELECOMMUNICATION NETWORK, excluded from | 1.2.13.8 |
| WORKING VOLTAGE | 2.10.2.1, 2.10.2.3 |
| semiconductor devices | |
| faults | 1.4.14, 5.3.7 |
| filled with insulating compound | 2.10.5.3, 2.10.5.4 |
| see also components and surge suppressor | |
| separate testing (of components, sub-assemblies etc.) | |
| components | 5.2.2, 5.3.7, 6.1.2.1, 6.2.2, 6.2.2.2 |
| enclosed parts | 5.3.1 |
| motors | B.2 |
| switch mode power supply unit | C.1, Annex X |
| transformers | Annex C |
| use of previous test results, preselection | 1.4.15, 1.5.2, 2.9.1, 4.7.3 |
| separation distance under a coating | |
| around a terminal | 2.10.7, Annex F (Figure F.10) |
| coated printed board | 2.10.6.2 (Table 2Q), R.1 |
| SERVICE ACCESS AREA | 1.2.7.2* |
| see also RESTRICTED ACCESS LOCATION and SERVICE PERSON | |
| service manual | see servicing instructions |
| SERVICE PERSON | 0.1, 1.2.13.5* |
| connectors accessible to | 4.3.5 |
| of a CABLE DISTRIBUTION SYSTEM | 7.2 |
| of a TELECOMMUNICATION NETWORK | 5.1.8.2, 6.1 |
| overriding a SAFETY INTERLOCK | 2.8.6 |
| protection | 1.1.1, 2.1.2, 2.2.3 |
| from | |
| mechanical hazard | 4.1, 4.4.3, 4.4.4 |
| unearthed part | 2.6.1 |
| unexpected hazard | 2.1.2, 2.1.3, 3.4.4 |
| to check earthing | 5.1.7.1 |
| warning notices | 1.7.9, 2.6.1, 2.7.6, 3.4.10 |
| see also RESTRICTED ACCESS LOCATION | |
| servicing instructions | 0.1, 1.7.2 |
| available only to SERVICE PERSON | 1.7.2.1 (note 3) |
| battery | 1.7.13 |
| disconnection | 1.7.2, 1.7.9, 2.6.5.5, 3.4.1 (note), 3.4.10, 3.4.11 |
| fuse in neutral, warning required | 2.7.6 |
| fuse rating | 1.7.6 |
| languages | 1.7.2.1 (note 3) |
| supply voltage adjustment | 1.7.4 |

| | | | |
|---|--|---|---|
| ultraviolet radiation warning | 4.3.13.4 | stand-by condition, marking | 1.7.8.3 |
| <i>see also</i> SERVICE PERSON | | starting pulses | 2.10.1.7, 2.10.2.1 i), 2.10.3.5 |
| sheath (of power supply cord) | 3.1.4, 3.2.5.1, 3.2.7 | STATIONARY EQUIPMENT | 1.2.3.4*, 4.5.3 (Table 4B), 5.1.6 (Table 5A) |
| shield <i>see</i> screens, conductive | | ENCLOSURE | 4.7.3.2 |
| shock, electric <i>see</i> electric shock | | flammability | A.1 |
| shock, mechanical <i>see</i> mechanical shock | | marking | 1.7.1, 4.6.2 |
| short-circuit | 2.7 | temperature of earthing terminal | 4.5.3 (Table 4B) |
| of | | TOUCH CURRENT | 5.1.7.1 |
| battery | 4.3.8 | steady force test when measuring CLEARANCE | 2.10.3.1 (note 5), G.6 (note 3) |
| components, for a test | 5.3.7 | steady force test, 10 N | 3.1.5, 3.1.9, 4.2.1, 4.2.2 |
| during servicing | 2.1.2, 2.1.3 | steady force test, 30 N | 4.2.1, 4.2.3 |
| insulation, for test | 2.2.4, 2.3.2.3, 2.3.2.4, 2.3.4, 2.10.2.1, 5.3.4 c) | steady force test, 250 N | 4.2.1, 4.2.4 |
| limited power source | 2.5 | steel ball impact test | 4.2.1, 4.2.5 |
| motor capacitor | B.8 | strain relief | |
| telecommunication wiring | 6.3 | on | |
| temperature limiter in unattended equipment | 5.3.8 | ELV wiring | 2.1.1.3 |
| transformer | C.1, Annex X | fluid container | 4.3.11 |
| protection against | 2.7, 3.1.1, 5.3.1 | internal wiring | 3.1.3 |
| <i>see also</i> energy hazard | | power cord (cord anchorage) | 3.2.6 |
| simulated | | stranded conductor | 1.2.5.6, 3.1.9, 3.3.8 |
| body impedance | 5.1, W.1.1 | stress, mechanical, on insulation | <i>see</i> mechanical stress, on insulation |
| conditions for test | 1.4.14, 5.3 | stress relief test on plastic material | 4.2.1, 4.2.7 |
| <i>Note - fault conditions are required to be simulated in numerous places in this standard</i> | | subassembly, this standard applies | 1.1.1 |
| external voltage | 2.3.5 | <i>see also</i> separate testing | |
| interference | Annex N | SUPPLEMENTARY INSULATION | 0.2.1, 1.2.9.3*, 1.2.9.4, 1.2.9.5 (note) |
| sleeving as additional insulation | 2.10.5.12, 3.1.4, 3.1.10 | application | 2.1.1.6, 2.9.3 |
| around insulating beads | 3.1.5 | as sleeving | 3.1.4, 3.1.10 |
| as conductor termination | 3.1.9 | in | |
| small part, flammability | 4.7.3.1 (note 3), 4.7.3.3, 4.7.3.4 | cord anchorage | 3.2.6 |
| socket-outlet Annex P (IEC 60083, IEC 60309, IEC 60906) | | cord guard | 3.2.7 |
| in building installation | | internal wiring | 2.1.1.3 |
| for DIRECT PLUG-IN EQUIPMENT | 1.2.3.6, 4.3.6 | manual control | 2.1.1.6 |
| for PLUGGABLE EQUIPMENT | 1.2.5.1, 1.2.5.2, 1.7.2.2, 2.3.2.3 c), 7.4.1 | power supply cord | 3.1.4 |
| protective earthing connection required | 5.1.7.1, 6.1.2.2 | printed board | 2.10.6, Annex F (Figure F.11) |
| reversible | 3.4.6, 4.3.7 | SELV CIRCUIT | 2.2.3 |
| on equipment | | wound component | 2.10.5.11 |
| accessibility | 2.1.1.1 | BASIC and SUPPLEMENTARY can be interchanged | 2.9.3 |
| load to be taken into account | 1.4.10, 5.3.7 | bridging <i>see</i> bridging of insulation | |
| marking | 1.7.5 | consequences of failure | 2.2.3, |
| socket <i>see</i> connectors <i>and</i> socket-outlet | | dimensions | 2.10.3, 2.10.4, 2.10.5 , Annex F, G.1.2 (note 1), G.6, R.2 |
| solenoid <i>see</i> wound component | | electric strength | 5.2 |
| SOLID INSULATION | 1.2.10.4*, 2.10.3.1 (note 1), 2.10.5 | integrity | |
| contact | 2.1.1.1 | after a test | 4.2.1, 5.3.7, 5.3.9.2 |
| electric strength | 5.2.1 | in service | 3.1.6, 3.3.8, 4.3.4 |
| formed by insulating compound | 2.10.5.3, Annex F (Figures F.16 <i>and</i> F.17) | one element of DOUBLE INSULATION | 2.10.2.1 e), 5.2.2, 5.3.9.2 |
| <i>see also</i> DISTANCE THROUGH INSULATION | | WORKING VOLTAGE | 2.10.2 |
| solvent-based enamel <i>see</i> enamel | | surge arrestor <i>see</i> surge suppressor | |
| special NON-DETACHABLE POWER SUPPLY CORD | 1.2.5.6*, 3.3.2 | surge suppressor | 1.5.9 , 2.6.1 e), 2.10.3.9, 5.2.2 (note 4), Clause 6 (note 1), 6.1.2.1 (Figure 6A), 6.2.2.2, 6.2.2.3, 7.1 (note 2), G.5, Annex S, Annex V (Figure V.7) |
| <i>see also</i> power supply cord | | <i>see also</i> components, removal during a test <i>and</i> separate testing | |
| stability | | | |
| of operation, thermal control | K.6 | | |
| physical | 4.1 | | |

| | | | |
|---|----------|---|--|
| switch | | | |
| arcing | | 4.7.3.2 | |
| as disconnect device | see | disconnection for servicing | |
| for an appliance | see | IEC 61058-1 | |
| forbidden in PROTECTIVE EARTHING CONDUCTOR and PROTECTIVE BONDING CONDUCTORS | | 2.6.5.2 | |
| functional | | 3.4.2 | |
| in a FIRE ENCLOSURE | | 4.7.2.1, 4.7.3.2 | |
| in a PRIMARY CIRCUIT | | 5.3.7 | |
| isolating | | 3.4.2, 3.4.5, 3.4.8 | |
| marking | | 1.7.8.1, 1.7.8.2, 1.7.8.3, 4.3.2 | |
| microgap, CLEARANCE not applicable | | 2.10.3.1, G.6 | |
| momentary contact | | 4.7.2.2 | |
| reed, reliability test | | 2.8.7.3 | |
| SAFETY INTERLOCK | | 2.8.3, 2.8.7, 4.3.13.4 | |
| terminals of | | 3.3.3 | |
| thermal control | | Annex K | |
| switch mode power supply | | 1.4.8, G.1.2 (note 1) | |
| testing | | C.1, Annex X | |
| | see also | peak voltage, repetitive | |
| symbols | | | |
| informative | | | |
| class II equipment | | 1.7.1, 2.6.2 | |
| earthing terminals | | 1.7.1, 1.7.7.1, 2.6.2 | |
| regulating devices | | 1.7.10 | |
| switches | | 1.7.8.3 | |
| warning | | | |
| electric shock | | 1.7.2.5, 2.7.6 | |
| hot part | | 4.5.4 (Table 4C/Footnotes a and c) | |
| ultraviolet radiation | | 4.3.13.4 | |
| | see also | ISO 7000 and IEC 60417 | |
| T | | | |
| TELECOMMUNICATION NETWORK | | 1.2.13.8* | |
| connected to an SELV CIRCUIT or a TNV CIRCUIT | | 1.2.13.8 (note 1), 1.4.8, 2.2.2 (note 1), 2.6.1, 3.5.1, 6.1.1 | |
| connections to | | 1.2.11.6, 1.4.11, Clause 6, W.2 | |
| earthing requirements | | 2.6 (note), 6.1.1 | |
| equipment powered from, included in Scope of this standard | | 1.1.1 | |
| not a reliable earth | | 2.6.5.8 | |
| operating voltage generated in | | 0.2.1, 2.3.2.3, 2.3.5, 2.10.2.1 h), 2.10.3.9 b), G.3, G.4.2, G.5 b) | |
| | see also | telephone ringing signals | |
| power limit 15 VA | | 1.4.11 | |
| separation from | | | |
| earth | | 6.1.2 | |
| hazardous voltage | | 6.1.1 | |
| parts of equipment | | 6.2 | |
| surge suppression | | 6.1.2.1 (Figure 6A) | |
| TOUCH CURRENT, to and from | | 2.6.1 f), 2.6.3, 5.1.8 | |
| TELECOMMUNICATION NETWORK TRANSIENT VOLTAGE | | | |
| 1.2.8.11 (Table 1A), 1.2.8.12, 1.2.8.13, 1.2.8.14, 1.2.9.11*, 1.2.13.8 (note 2), 1.4.8, 2.10.3.4, 2.10.3.8, G.1.2, G.3, G.4.2, G.5 b) | | | |
| measuring reduced voltage | | 2.10.3.9 b), G.5 b) | |
| telecommunication wiring, protection | | 6.3 | |
| telegraph signals, not considered | | 2.3.1 (note 4) | |
| telephone ringing signal | | Annex M | |
| considered as operating voltage | | 0.2.1, 1.4.8 | |
| disregarded for CREEPAGE DISTANCE | | 2.10.2.1 h) | |
| frequency | | M.2 (note), M.3.1.1 | |
| in a RESTRICTED ACCESS LOCATION | | 2.1.3 | |
| maximum level | | 2.3.1 b), M.2, M.3 | |
| television distribution system | | | |
| see | | cable distribution system | |
| temperature | | | |
| ambient during a test | | 1.4.4, 1.4.12, 2.9.2, 3.2.8, Annex E, U.2 | |
| applied to part under test | | 2.9.1, 2.10.8.2, 2.10.9, 4.2.7, 4.5.5, 4.6.5, 5.2.1 | |
| conditioning | | 4.6.5, A.1.2, A.2.2 | |
| extreme | | 1.1.2 | |
| hazard | | 0.2.3, 0.2.4, 2.9.1, 4.5.4 (Table 4C) | |
| heat sink | | 4.5.4 | |
| maximum | see | maximum temperature | |
| measurement | | 1.4.12, 1.4.13, 4.5.2 | |
| winding | | 4.5.3 (Table 4B), Annex E | |
| | Note - | temperature measurements are required in numerous places in this standard | |
| TEMPERATURE LIMITER | | 1.2.11.2*, 1.5.3, 1.7.10, 5.3.8, Annex K | |
| operation during a test | | 4.5.2 | |
| terminals | see | wiring terminals | |
| test, testing | | | |
| | see also | tests, specific and separate testing | |
| applicable only if safety is involved | | 1.4.1 | |
| checking compliance using previous test results | | 1.4.15 | |
| choice of methods of test | | 1.3.7 | |
| endurance | see | endurance testing | |
| equipment not operational after a test | | 1.4.1 | |
| general conditions | | 1.4 | |
| reliability | see | endurance testing | |
| ROUTINE | see | ROUTINE TEST | |
| samples | see | samples for test | |
| SAMPLING | see | SAMPLING TEST | |
| test finger | | | |
| 2.1.1.1 (Figures 2A and 2D), Annex F (Figure F.12) | | | |
| | Note - | the test finger is specified for checking accessibility in numerous places in this standard | |
| test pin | | 2.1.1.1 and Figure 2B | |
| test probe | | 2.1.1.1 and Figure 2C, 6.2.1 b) | |
| TYPE | see | TYPE TEST | |
| tests, specific | | | |
| abnormal conditions | | 5.3 | |
| abrasion resistance | | 2.10.7, 2.10.8.4, R.1 (Table R.1) | |
| adhesive durability | | 4.6.5 | |
| ball pressure | | 4.5.5 | |
| capacitor | | 1.5.6 | |
| current supplied to telecommunication wiring | | 6.3 | |
| drop | | 4.2.1, 4.2.6 | |
| durability of marking | | 1.7.11 | |
| electric strength | see | electric strength test | |
| flammability | | Annex A | |
| glow-wire | | 4.7.3.1, Annex P (IEC 60695-2-11) | |
| hot flaming oil | | 4.6.2, A.3 | |
| hot wire ignitability | | 4.7.3.2 | |
| ignition | | 4.6.4, 4.7, A.3 | |
| impact | | 4.2.1, 4.2.5, 4.3.13.3 | |
| implosion (cathode ray tubes) | | 4.2.8 | |
| impulse | see | impulse test | |
| mandrel | | 2.10.5.8, Annex AA | |
| mechanical strength | see | mechanical strength | |
| needle flame | | 4.6.2, 4.7.3.6, Annex P (IEC 60695-2-2) | |
| resistance of earthing conductor | | 2.6.3.4 | |

| | | | |
|---|---|--|---|
| resistor | 1.5.7 | separation | |
| stability | 4.1 | from accessible part | 2.3.2.1 |
| steady force, 10 N | 3.1.5, 3.1.9, 4.2.1, 4.2.2 | from HAZARDOUS VOLTAGE | 2.3.3, 2.9.4, 3.1.9 |
| steady force, 30 N | 4.2.1, 4.2.3 | from an SELV CIRCUIT and from other TNV CIRCUITS | 2.3.2.1, 2.9.3 (Table 2H) |
| steady force, 250 N | 4.2.1, 4.2.4 | WORKING VOLTAGE | 2.10.2.1 h), 2.10.2.2, 2.10.2.3 |
| steel ball impact | 4.2.1, 4.2.5 | TNV-1 CIRCUIT | 1.2.8.12*, 2.2.2 (note 1), 2.3.1 a) |
| stress relief on plastic material | 4.2.1, 4.2.7 | separation from parts of equipment | 6.2.1 |
| surge | 7.4.2 | treated as a TNV-3 CIRCUIT | 2.3.2.1 |
| temperature | 4.5 | TNV-2 CIRCUIT | 1.2.8.13*, 2.3.1 b) |
| TOUCH CURRENT | 5.1 | treated as a TNV-3 CIRCUIT | 2.3.2.1 |
| transient voltage | 2.10.3.9, G.5 | TNV-3 CIRCUIT | 1.2.8.14*, 2.3.1 b) |
| see also conditioning of test samples | | separation from parts of equipment | 6.2.1 |
| TFE (tetrafluoro ethylene) | 4.7.2.2, 4.7.3.3, 4.7.3.4 | tolerances | |
| THERMAL CUTOUT | 1.2.11.3*, 1.5.3, 4.3.7, 5.3.1, 5.3.2, 5.3.3, 5.3.8, B.2, C.1, Annex K, Annex X | frequency | 1.4.6 |
| AUTOMATIC RESET | 1.2.11.4*, 4.4.1 | manufacturing | 0.1 |
| contact gap, CLEARANCE not applicable | 2.10.3.1, G.6 | voltage | 1.4.5 |
| integrity after a test | 4.2.1 | during TOUCH CURRENT tests | 5.1.3 |
| MANUAL RESET | 1.2.11.5* | TOOL | 1.2.7.4* |
| not to operate during heating test | 4.5.2 | not required for an OPERATOR ACCESS AREA | 1.2.7.1 |
| thermal requirements | 4.5 | required for | |
| thermoplastic part | 4.2.7, 4.5.2, 4.5.3, 4.5.5 | access | 1.2.7.3, 1.7.2.5, 3.2.9 |
| THERMOSTAT | 1.2.11.1*, 1.4.4, 1.5.3, 1.7.10, 4.3.7, 5.3.8, Annex K | adjustment | 1.4.4, 4.3.3 |
| contact gap, CLEARANCE not applicable | 2.10.3.1, G.6 | replacement of special cord | 1.2.5.6 |
| not to operate during heating test | 4.5.2 | required to | |
| thickness (of insulation) see distance through insulation | | open a battery compartment | 2.1.1.2 |
| thin sheet insulating material | 2.10.5.6 , 2.10.6.4 (Table 2R), C.2, Annex F (Figure F.15) | override a SAFETY INTERLOCK | 2.8.6 |
| electric strength testing | 5.2.1 | remove a bushing or cord guard | 3.2.7 |
| non-separable | 2.10.5.8, 2.10.5.9, Annex AA | remove a guard against water ingress | Annex T |
| prepreg, layers counted before curing | 2.10.6.4 (Table 2R/Footnote b) | risk of short-circuit during servicing | 2.1.2 |
| separable | 2.10.5.7, 2.10.5.9, 2.10.5.10 | TOUCH CURRENT | 0.2.1, 1.2.13.12*, 5.1 , Annexes D and W |
| three-phase | | high TOUCH CURRENT | 5.1.7, 5.1.8.2 a) |
| disconnect device | 3.4.7 | measuring instruments | Annex D |
| motor | B.9 | r.m.s or peak current | 5.1.6 (note) |
| overcurrent protection, examples | 2.7.4 (Tables) | summation | 5.1.8.2, Annex W |
| power distribution system | Annex V | to and from a TELECOMMUNICATION NETWORK | 2.6.1 f), 5.1.8 |
| rotation, marking if critical | 1.7.7.2 | tracking | 2.10.4.1, 2.10.4.2 , Annex P (IEC 60112) |
| TOUCH CURRENT | 5.1.3, 5.1.5, 5.1.7.1 a), 5.1.8.1 | transformer | 1.5.4, Annex C |
| TN power distribution system | 1.6.1, 5.1.3, V.2 | ceramic | 2.10.6 (note) |
| overcurrent protection | 2.7.4 (Tables) | conductive foil as screen | C.2 |
| TNV CIRCUIT | 1.2.8.11*, 2.3 | core | 2.9.3 (Table 2H), C.2 |
| accessibility | 2.1.1.1, 2.1.1.6, 2.1.2, 2.1.3 | ferrite core | C.1 |
| in battery compartment | 2.1.1.2 | ferro-resonant | C.1, Annex X |
| via another circuit | 6.2.1 | high voltage | 4.7.3.6 |
| boundary of | 2.3.4 | in FIRE ENCLOSURE | 4.7.2.1, 4.7.2.2 |
| compared with an SELV CIRCUIT | 1.2.8.11 (Table 1A) | in TOUCH CURRENT testing | 5.1.3 |
| connected to a CABLE DISTRIBUTION SYSTEM | 7.2 | insulation | 2.9.3, 2.10.2, C.2 |
| connected to a TELECOMMUNICATION NETWORK | 1.4.11, 2.10.3.8, Clause 6 (note 5), 6.1.1 , G.3 | varying dimensions | 2.10.1.5, 5.2.2 |
| connection to other circuits | 2.3.4 | isolating | 1.2.8.5 |
| connection to other equipment | 3.5.1, 3.5.2 | in limited power source | 2.5 |
| connectors | 4.3.5 | in SELV CIRCUIT | 2.2.4 |
| considered to be a SECONDARY CIRCUIT | 1.2.8.11 | in TNV CIRCUIT | 2.3.4 |
| earthing | 2.3.2.3, 2.6.1, 2.6.3.4 | used for test | 5.1.3 |
| FIRE ENCLOSURE not required | 1.4.11, 4.7.2.2 | maximum temperature | C.1, Annex X |
| insulation | 2.9.3 | not in Scope of this standard unless integral | |
| maximum voltages | 2.3.1 | in equipment | 1.1.3 |
| normal voltages | 1.4.8 | overload protection | 5.3.3, C.1, Annex X |
| | | planar | 2.10.5.11, 2.10.6 (note) |
| | | power distribution | V.1, V.2 |
| | | screen see screen, conductive | |
| | | signal | Clause 6 (note 4), 6.2.2, 7.1 (note 4), W.2.1 |
| | | testing | 2.10.9, 5.2.1, 5.3.7, C.1, Annex X |

winding wire *see* winding wire
 WORKING VOLTAGE 2.10.2

transients
 affecting CLEARANCES 2.10.3.1, 2.10.3.4, 2.10.3.9
 affecting WORKING VOLTAGE 1.2.9.8, 2.10.2
 attenuated
 2.6.1 e), 2.10.3.9, Clause 6 (note 1),
 7.1 (note 2), G.2.1, G.5, Annex Z
 CLEARANCES 2.10.3.1, 2.10.3.4, 2.10.3.9
 disregarded for CREEPAGE DISTANCE 2.10.4
 in PRIMARY CIRCUIT
 1.2.9.10, 2.10.3.2, 2.10.3.3, G.1, G.4.1 a)
 in SECONDARY CIRCUIT 2.10.3.3, 2.10.3.6, 2.10.3.7,
 G.1, G.4.1 b)
 in TNV CIRCUIT 1.2.8.12, 1.2.8.13, 1.2.8.14
 not part of operating voltage 1.4.8
 internally generated 2.10.2.3, G.1, G.4.1 a)
 measurement in a SECONDARY CIRCUIT 2.10.3.3, G.5
 non-repetitive, not affecting WORKING VOLTAGE
 1.4.8, 2.10.2.2, 2.10.2.3

on a TELECOMMUNICATION NETWORK
 see TELECOMMUNICATION NETWORK TRANSIENT VOLTAGE

simulated Annex N
 see also impulse test, MAINS TRANSIENT VOLTAGE and
 overvoltage category

transport
 castors 1.2.3.1, 4.1
 conditions during 2.6.5.6
 orientation 1.3.6
 precautions during 0.1, 1.7.2.1, 4.6.4

TRANSPORTABLE EQUIPMENT
 0.1, 1.2.3.3*, 4.2.6, 4.3.8, 4.6.1, 4.6.4, 5.1.6 (Table 5A)
 orientation 1.3.6

TT power distribution system 1.6.1, 5.1.3, V.3
 protective device 2.7.4 (tables)

TYPE TEST 1.2.13.1*, 1.4.2, 1.4.15, 1.5.6,
 2.10.5.4, 2.10.5.13, 2.10.6.4 (Table 2R), U.2

U

ultraviolet radiation 0.2.6
 effect on materials 4.3.13.3, Annex Y
 human exposure 4.3.13.4

unattended equipment, testing 5.3.8

unearthed (floating)
 conductor in MAINS SUPPLY 2.7.4, 2.10.3.2 c), 3.4.6, G.2.3
 ENCLOSURE 2.9.3, 4.2.1
 EUT during TOUCH CURRENT tests 5.1.3
 meaning of "unearthed" 2.9.3 (Table 2H)
 parts and windings
 1.4.9, 2.6.3.4, 6.2.1, Annex F (Figure F.13)
 accessibility 0.2.1, 2.1.1.1
 in determination of WORKING VOLTAGE
 2.10.2.1 a), 2.10.2.1 b)
 separation
 from internal wiring 2.1.1.3, 2.1.1.4
 from stranded wire 3.3.8
 TOUCH CURRENT test 5.1.5, W.1
 within DOUBLE INSULATION 2.9.3

uninsulated (bare) conductors and parts
 0.2.1, 2.1.1.1, 2.1.1.2, 2.1.1.5, 2.1.2,
 2.1.3, 3.2.2, 3.2.9, 4.2.1, 4.6.1, 4.6.4
 see also busbar

USER 0.1, 0.2.1, 1.2.13.6*, 1.2.13.7
 (*or* OPERATOR which has the same meaning)

handling equipment
 battery 4.3.8
 high pressure lamp 4.2.9
 insulation 2.10.5.6
 MOVABLE EQUIPMENT 4.2.6
 screws 3.1.8
 stability 4.1
 switch, no FIRE ENCLOSURE 4.7.2.2
 information supplied to *see* operating instructions
 of cable distribution equipment 6.2, 7.2, 7.3
 of telecommunication equipment 6.1, 6.2

V

vapour 0.2.7, 1.2.12.15, 4.3.12

voltage dependent resistor (VDR) 1.5.9, Annex Q
 see also surge suppressor

vibration *see* mechanical shock

VOLTAGE, HAZARDOUS *see* HAZARDOUS VOLTAGE

VOLTAGE, RATED *see* RATED VOLTAGE

VOLTAGE, REQUIRED WITHSTAND
 see REQUIRED WITHSTAND VOLTAGE

VOLTAGE, WORKING *see* WORKING VOLTAGE

voltage
 equipment to be safe at any supply voltage 1.3.3
 for tests 1.4.5
 generated externally 2.3.5
 steady-state, not covered by this standard 1.4.8 (note 1)
 measurement to earth 1.4.9
 normal operating 1.4.8
 rating *see* rated voltage of components
 r.m.s. value implied unless otherwise specified 1.2
 selector 1.7.1, 1.7.4, 4.3.3

W

wall-mounted equipment 1.2.3.5, 4.2.10

warning notices
 battery 1.7.13
 examples for reduction of hazards
 0.1, 0.2.4, 0.2.5, 0.2.6, 0.2.7
 high TOUCH CURRENT 5.1.7, 5.1.8.2 a)
 moving part 4.4.2
 temperature 4.5.4 (Table 4C/Footnotes a and c)
 to SERVICE PERSON 1.7.9, 2.6.1, 2.7.6, 3.4.10, 4.3.5, 4.3.13.4
 see also symbols, warning

water ingress 1.1.2, 2.10.1.2, Annex T

weight *see* mass

wire, wiring **Clause 3**
 access to, in
 an ELV CIRCUIT 2.1.1.3
 a HAZARDOUS VOLTAGE circuit 2.1.1.4
 fixed *see* fixing of parts, wiring
 enamelled *see* enamel
 equipment 3.1.4
 gauge (AWG, cmil) 2.6.3.3 (Table 2D), 3.2.5.1 (Table 3B)
 insulation
 colour 2.6.3.5

| | | | |
|--|---|--|---|
| flammability | 4.7.3.3, 4.7.3.4 | marking | |
| in FIRE ENCLOSURE | 4.7.2.1, 4.7.2.2 | power supply | 1.7.7.2, 1.7.7.3 |
| resistance to oil | 4.3.9 | protective earthing | 1.7.7.1 |
| UV exposure | 4.3.13.3 | more than one | 2.6.4.2 |
| overcurrent protection | 2.7 , 3.1.1 | of transformer | C.2 |
| physical protection | 3.1.2 , 3.1.3, 4.3.13.3 | separate protective earthing terminal | 5.1.7.1 |
| printed | 2.6.3.5, Annex F (Figure F.11) | temperature | 4.5.3 (Table 4B) |
| sleeved <i>see</i> sleeving as additional insulation | | wound component | 2.10.5.11 , 2.10.5.12, 2.10.5.13, 2.10.5.14, 4.7.1, Annex U |
| stranded | 3.3.8 | <i>see also</i> motor <i>and</i> transformer | |
| telecommunication | 6.3 | working voltage | 1.2.9.6* |
| temperature | 4.5.3 | determination of | 1.4.8, 2.10.2 |
| terminals <i>see</i> wiring terminals | | meaning, for DOUBLE INSULATION | 2.10.2.1 e) |
| termination | 3.1.9 | PEAK <i>see</i> PEAK WORKING VOLTAGE | |
| winding | 2.10.5.12, 2.10.5.13, Annex U | RMS <i>see</i> RMS WORKING VOLTAGE | |
| <i>see also</i> current carrying capacity <i>and</i> building installation | | to be considered | 1.5.7.2, 2.9.1, 2.9.3 (Table 2H/Footnotes b <i>and</i> c) |
| wiring terminals | 1.7.7 , 2.6.4, 3.1 , 3.2.1, 3.2.3, 3.3 | varying | 2.10.1.5 |
| access | 3.2.9 | <i>see also</i> rated voltage of components | |
| ampacity | 2.6.4.2, 3.3.4, 3.3.5 | WRAPPING TISSUE | 1.2.13.16*, 4.7.3.6, B.6.3, B.7.3 |
| corrosion | 2.6.5.6 | X | |
| grouping | 3.3.7 | x-ray <i>see</i> ionizing radiation | |
| main protective earthing terminal | 1.2.13.10, 1.2.13.11, 1.4.9, 2.3.2.3, 2.6.1, 2.6.3.4, 2.6.4.2 , 2.6.4.3, 2.9.4 d) <i>and</i> e), 5.1.6 (Table 5A), 5.1.7.1, 5.1.8.2, 7.4.2, G.5 a) | | |
| equipment with | 5.1.7.1, 5.1.8.1 | | |
| equipment without | 2.6.2, 5.1.8.1 | | |

Annex ZA (normative)

Normative references to international publications with their corresponding European publications

The following referenced documents are indispensable for the application of this document. For dated references, only the edition cited applies. For undated references, the latest edition of the referenced document (including any amendments) applies.

NOTE Where an International Publication has been modified by common modifications, indicated by (mod), the relevant EN/HD applies.

| <u>Publication</u> | <u>Year</u> | <u>Title</u> | <u>EN/HD</u> | <u>Year</u> |
|-----------------------|-----------------|---|---------------------|-------------------------|
| IEC 60065 (mod) A1 | 2001 2005 | Audio, video and similar electronic apparatus - Safety requirements | EN 60065 A1 | 2002 - ¹⁾ |
| IEC 60068-2-78 | - ²⁾ | Environmental testing Part 2-78: Tests - Test Cab: Damp heat, steady state | EN 60068-2-78 | 2001 ³⁾ |
| IEC 60073 | - ²⁾ | Basic and safety principles for man-machine interface, marking and identification - Coding principles for indication devices and actuators | EN 60073 | 2002 ³⁾ |
| IEC 60083 | - ²⁾ | Plugs and socket-outlets for domestic and similar general use standardized in member countries of IEC | - | - |
| IEC 60085 | 2004 | Electrical insulation - Thermal classification | EN 60085 | 2004 |
| IEC 60112 | - ²⁾ | Method for determining the proof and comparative tracking indices of insulating materials | EN 60112 | 2003 ³⁾ |
| IEC 60216-4-1 | - ²⁾ | Guide for the determination of thermal endurance properties of electrical insulating materials Part 4: Ageing ovens Section 1: Single-chamber ovens | EN 60216-4-1 | - ¹⁾ |
| IEC 60227 (mod) | Series | Polyvinyl chloride insulated cables of rated voltages up to and including 450/750V | HD 21 ⁴⁾ | Series |
| IEC 60245 (mod) | Series | Rubber insulated cables of rated voltages up to and including 450/750V | HD 22 ⁵⁾ | Series |

¹⁾ To be published.

²⁾ Undated reference.

³⁾ Valid edition at date of issue.

⁴⁾ The HD 21 series is related to, but not directly equivalent with the IEC 60227 series.

⁵⁾ The HD 22 series is related to, but not directly equivalent with the IEC 60245 series.

| <u>Publication</u> | <u>Year</u> | <u>Title</u> | <u>EN/HD</u> | <u>Year</u> |
|-----------------------|----------------------|---|-------------------------|--------------------|
| IEC 60309 | Series | Plugs, socket-outlets and couplers for industrial purposes | EN 60309 | Series |
| IEC 60317 | Series | Specifications for particular types of winding wires | EN 60317 | Series |
| IEC 60317-43 | - ²⁾ | Part 43: Aromatic polyimide tape wrapped round copper wire, class 240 | EN 60317-43 | 1997 ³⁾ |
| IEC 60320 (mod) | Series | Appliance couplers for household and similar general purposes | EN 60320 | Series |
| IEC 60364-1 (mod) | 2001 | Electrical installations of buildings Part 1: Fundamental principles, assessment of general characteristics, definitions | HD 384.1 S2 | 2001 |
| IEC 60384-14 A1 | 1993 1995 | Fixed capacitors for use in electronic equipment Part 14: Sectional specification: Fixed capacitors for electromagnetic interference suppression and connection to the supply mains | EN 132400 ⁶⁾ | 1994 |
| IEC 60417 | Data-base | Graphical symbols for use on equipment | - | - |
| IEC 60664-1 + A1 + A2 | 1992 2000 2002 | Insulation coordination for equipment within low-voltage systems Part 1: Principles, requirements and tests | EN 60664-1 | 2003 |
| IEC 60695-2-11 | - ²⁾ | Fire hazard testing Part 2-11: Glowing/hot-wire based test methods - Glow-wire flammability test method for end-products | EN 60695-2-11 | 2001 ³⁾ |
| IEC 60695-2-20 | - ²⁾ | Part 2-20: Glowing/hot-wire based test methods - Hot-wire coil ignitability - Apparatus, test method and guidance | - | - |
| IEC 60695-10-2 | - ²⁾ | Part 10-2: Guidance and test methods for the minimization of the effects of abnormal heat on electrotechnical products involved in fires - Method for testing products made from non-metallic materials for resistance to heat using the ball pressure test | EN 60695-10-2 | 2003 ³⁾ |
| IEC 60695-11-3 | - ²⁾ | Part 11-3: Test flames - 500 W flames - Apparatus and confirmational test methods | - | - |
| IEC 60695-11-4 | - ²⁾ | Part 11-4: Test flames - 50 W flames - Apparatus and confirmational test methods | - | - |

⁶⁾ EN 132400, *Sectional Specification: Fixed capacitors for electromagnetic interference suppression and connection to the supply mains (Assessment level D)*, and its amendments are related to, but not directly equivalent to IEC 60384-14. They are superseded by EN 60384-14:2005, which is based on IEC 60384-14:2005.

| <u>Publication</u> | <u>Year</u> | <u>Title</u> | <u>EN/HD</u> | <u>Year</u> |
|-------------------------|----------------------|--|---|--------------------------------------|
| IEC 60695-11-10 | - ²⁾ | Part 11-10: Test flames - 50 W horizontal and vertical flame test methods | EN 60695-11-10 | 1999 ³⁾ |
| IEC 60695-11-20 | - ²⁾ | Part 11-20: Test flames - 500 W flame test methods | EN 60695-11-20 | 1999 ³⁾ |
| IEC 60730-1 (mod) A1 | 1999 2003 | Automatic electrical controls for household and similar use - Part 1: General requirements | EN 60730-1 A1 + A12 + A13 + A14 | 2000 2004 2003 2004 2005 |
| IEC 60747-5-5 | - ¹⁾ | Semiconductor devices - Discrete devices Part 5-5: Optoelectronic devices - Photocouplers | - | - |
| IEC 60825-1 | - ²⁾ | Safety of laser products Part 1: Equipment classification, requirements and user's guide | EN 60825-1 + corr. February + A11 | 1994 ³⁾ 1995 1996 |
| IEC 60825-2 | - ²⁾ | Part 2: Safety of optical fibre communication systems | EN 60825-2 | 2004 ³⁾ |
| IEC/TR 60825-9 | - ²⁾ | Part 9: Compilation of maximum permissible exposure to incoherent optical radiation | - | - |
| IEC 60825-12 | - ²⁾ | Part 12: Safety of free space optical communication systems used for transmission of information | EN 60825-12 | 2004 ³⁾ |
| IEC 60851-3 A1 | 1996 1997 | Winding wires - Test methods Part 3: Mechanical properties | EN 60851-3 A1 | 1996 1997 |
| IEC 60851-5 A1 A2 | 1996 1997 2004 | Part 5: Electrical properties | EN 60851-5 A1 A2 | 1996 1997 2004 |
| IEC 60851-6 | 1996 | Part 6: Thermal properties | EN 60851-6 | 1996 |
| IEC 60885-1 | 1987 | Electrical test methods for electric cables Part 1: Electrical tests for cables, cords and wires for voltages up to and including 450/750 V | - | - |
| IEC 60906-1 | - ²⁾ | IEC System of plugs and socket-outlet for household and similar purposes Part 1: Plugs and socket-outlets 16 A 250 V a.c. | - | - |
| IEC 60906-2 | - ²⁾ | Part 2: Plugs and socket-outlets 15 A 125 V a.c. | - | - |
| IEC 60947-1 | 2004 | Low voltage switchgear and control gear Part 1: General rules | EN 60947-1 | 2004 |
| IEC 60990 | 1999 | Methods of measurement of touch current and protective conductor current | EN 60990 | 1999 |

| <u>Publication</u> | <u>Year</u> | <u>Title</u> | <u>EN/HD</u> | <u>Year</u> |
|---------------------------------|-----------------|---|--------------------------|--------------------|
| IEC 61051-2 | 1991 | Varistors for use in electronic equipment Part 2: Sectional specification for surge suppression varistors | - | - |
| IEC 61058-1 (mod) | 2000 | Switches for appliances Part 1: General requirements | EN 61058-1 ⁷⁾ | 2002 |
| ISO 178 | - ²⁾ | Plastics - Determination of flexural properties | EN ISO 178 | 2003 |
| ISO 179 | Series | Plastics - Determination of Charpy impact strength | EN ISO 179 | Series |
| ISO 180 | - ²⁾ | Plastics - Determination of Izod impact strength | EN ISO 180 | 2000 ³⁾ |
| ISO 261 | - ²⁾ | ISO general-purpose metric screw threads - General plan | - | - |
| ISO 262 | - ²⁾ | ISO general-purpose metric screw threads - Selected sizes for screws, bolts and nuts | - | - |
| ISO 527 | Series | Plastics - Determination of tensile properties | EN ISO 527 | Series |
| ISO 3864 | Series | Safety colours and safety signs | - | - |
| ISO 4892-1 | - ²⁾ | Plastics - Methods of exposure to laboratory light sources Part 1: General guidance | EN ISO 4892-1 | 2000 |
| ISO 4892-2 | - ²⁾ | Part 2: Xenon-arc sources | EN ISO 4892-2 | 1999 |
| ISO 4892-4 | - ²⁾ | Part 4: Open-flame carbon-arc lamps | - | - |
| ISO 7000 | Data- base | Graphical symbols for use on equipment - Index and synopsis | - | - |
| ISO 8256 | - ²⁾ | Plastics - Determination of tensile-impact strength | EN ISO 8256 | 2004 |
| ISO 9772 | - ²⁾ | Cellular plastics - Determination of horizontal burning characteristics of small specimens subjected to a small flame | - | - |
| ISO 9773 | - ²⁾ | Plastics - Determination of burning behaviour of thin flexible vertical specimens in contact with a small-flame ignition source | EN ISO 9773 | 1998 ³⁾ |
| ITU-T Recommendation K.44 | - ²⁾ | Resistibility tests for telecommunication equipment exposed to overvoltages and overcurrents - Basic Recommendation | - | - |

⁷⁾ EN 61058-1:2002 includes A1:2001 to IEC 61058-1:2000.

Annex ZB
(normative)

Special national conditions

Special national condition: National characteristic or practice that cannot be changed even over a long period, e.g. climatic conditions, electrical earthing conditions.

NOTE If it affects harmonization, it forms part of the European Standard / Harmonization Document.

For the countries in which the relevant special national conditions apply these provisions are normative, for other countries they are informative.

| Clause | Special national condition |
|---------|--|
| 1.2.4.1 | In Denmark , certain types of Class I appliances (see 3.2.1.1) may be provided with a plug not establishing earthing conditions when inserted into Danish socket-outlets. |
| 1.5.7.1 | In Finland, Norway and Sweden , resistors bridging BASIC INSULATION in CLASS I PLUGGABLE EQUIPMENT TYPE A must comply with the requirements in 1.5.7.2. |
| 1.5.8 | In Norway , due to the IT power system used (see annex V, Figure V.7), capacitors are required to be rated for the applicable line-to-line voltage (230 V). |
| 1.5.9.4 | In Finland, Norway and Sweden , the third dashed sentence is applicable only to equipment as defined in 6.1.2.2 of this annex. |
| 1.7.2.1 | <p>In Finland, Norway and Sweden, CLASS I PLUGGABLE EQUIPMENT TYPE A intended for connection to other equipment or a network shall, if safety relies on connection to protective earth or if surge suppressors are connected between the network terminals and accessible parts, have a marking stating that the equipment must be connected to an earthed mains socket-outlet.</p> <p>The marking text in the applicable countries shall be as follows:</p> <p>In Finland: "Laite on liitettävä suojamaadoituskoskettimilla varustettuun pistorasiaan"</p> <p>In Norway: "Apparatet må tilkoples jordet stikkontakt"</p> <p>In Sweden: "Apparaten skall anslutas till jordat uttag"</p> |
| 1.7.5 | In Denmark , socket-outlets for providing power to other equipment shall be in accordance with the Heavy Current Regulations, Section 107-2-D1, Standard Sheet DK 1-3a, DK 1-5a or DK 1-7a, when used on Class I equipment. For STATIONARY EQUIPMENT the socket-outlet shall be in accordance with Standard Sheet DK 1-1b or DK 1-5a. |
| 2.2.4 | In Norway , for requirements see 1.7.2.1, 6.1.2.1 and 6.1.2.2 of this annex. |
| 2.3.2 | In Finland, Norway and Sweden there are additional requirements for the insulation. See 6.1.2.1 and 6.1.2.2 of this annex. |
| 2.3.4 | In Norway , for requirements see 1.7.2.1, 6.1.2.1 and 6.1.2.2 of this annex. |
| 2.6.3.3 | In the United Kingdom , the current rating of the circuit shall be taken as 13 A, not 16 A. |

| Clause | Special national condition | | | | | | | | | | | | | | | | | | | | | | | | |
|-----------------|---|-----------------|-----------------|---------|-----------------|-----------------|--------------|-----|-------------|-----------------|--------------|--------|-------------|-----------------|--------------|---------|-----------------|-----------------|--------------|-----|-------------|-----------------|--------------|--------|-------------|
| 2.7.1 | In the United Kingdom , to protect against excessive currents and short-circuits in the PRIMARY CIRCUIT of DIRECT PLUG-IN EQUIPMENT, tests according to 5.3 shall be conducted, using an external protective device rated 30 A or 32 A. If these tests fail, suitable protective devices shall be included as integral parts of the DIRECT PLUG-IN EQUIPMENT, so that the requirements of 5.3 are met. | | | | | | | | | | | | | | | | | | | | | | | | |
| 2.10.5.13 | In Finland, Norway and Sweden , there are additional requirements for the insulation, see 6.1.2.1 and 6.1.2.2 of this annex. | | | | | | | | | | | | | | | | | | | | | | | | |
| 3.2.1.1 | <p>In Switzerland, supply cords of equipment having a RATED CURRENT not exceeding 10 A shall be provided with a plug complying with SEV 1011 or IEC 60884-1 and one of the following dimension sheets:</p> <table border="0" data-bbox="347 689 1134 786"> <tr> <td>SEV 6532-2.1991</td> <td>Plug Type 15</td> <td>3P+N+PE</td> <td>250/400 V, 10 A</td> </tr> <tr> <td>SEV 6533-2.1991</td> <td>Plug Type 11</td> <td>L+N</td> <td>250 V, 10 A</td> </tr> <tr> <td>SEV 6534-2.1991</td> <td>Plug Type 12</td> <td>L+N+PE</td> <td>250 V, 10 A</td> </tr> </table> <p>In general, EN 60309 applies for plugs for currents exceeding 10 A. However, a 16 A plug and socket-outlet system is being introduced in Switzerland, the plugs of which are according to the following dimension sheets, published in February 1998:</p> <table border="0" data-bbox="347 927 1134 1023"> <tr> <td>SEV 5932-2.1998</td> <td>Plug Type 25</td> <td>3L+N+PE</td> <td>230/400 V, 16 A</td> </tr> <tr> <td>SEV 5933-2.1998</td> <td>Plug Type 21</td> <td>L+N</td> <td>250 V, 16 A</td> </tr> <tr> <td>SEV 5934-2.1998</td> <td>Plug Type 23</td> <td>L+N+PE</td> <td>250 V, 16 A</td> </tr> </table> | SEV 6532-2.1991 | Plug Type 15 | 3P+N+PE | 250/400 V, 10 A | SEV 6533-2.1991 | Plug Type 11 | L+N | 250 V, 10 A | SEV 6534-2.1991 | Plug Type 12 | L+N+PE | 250 V, 10 A | SEV 5932-2.1998 | Plug Type 25 | 3L+N+PE | 230/400 V, 16 A | SEV 5933-2.1998 | Plug Type 21 | L+N | 250 V, 16 A | SEV 5934-2.1998 | Plug Type 23 | L+N+PE | 250 V, 16 A |
| SEV 6532-2.1991 | Plug Type 15 | 3P+N+PE | 250/400 V, 10 A | | | | | | | | | | | | | | | | | | | | | | |
| SEV 6533-2.1991 | Plug Type 11 | L+N | 250 V, 10 A | | | | | | | | | | | | | | | | | | | | | | |
| SEV 6534-2.1991 | Plug Type 12 | L+N+PE | 250 V, 10 A | | | | | | | | | | | | | | | | | | | | | | |
| SEV 5932-2.1998 | Plug Type 25 | 3L+N+PE | 230/400 V, 16 A | | | | | | | | | | | | | | | | | | | | | | |
| SEV 5933-2.1998 | Plug Type 21 | L+N | 250 V, 16 A | | | | | | | | | | | | | | | | | | | | | | |
| SEV 5934-2.1998 | Plug Type 23 | L+N+PE | 250 V, 16 A | | | | | | | | | | | | | | | | | | | | | | |
| 3.2.1.1 | <p>In Denmark, supply cords of single-phase equipment having a rated current not exceeding 13 A shall be provided with a plug according to the Heavy Current Regulations, Section 107-2-D1.</p> <p>CLASS I EQUIPMENT provided with socket-outlets with earth contacts or which are intended to be used in locations where protection against indirect contact is required according to the wiring rules shall be provided with a plug in accordance with standard sheet DK 2-1a or DK 2-5a.</p> <p>If poly-phase equipment and single-phase equipment having a RATED CURRENT exceeding 13 A is provided with a supply cord with a plug, this plug shall be in accordance with the Heavy Current Regulations, Section 107-2-D1 or EN 60309-2.</p> | | | | | | | | | | | | | | | | | | | | | | | | |
| 3.2.1.1 | <p>In Spain, supply cords of single-phase equipment having a rated current not exceeding 10 A shall be provided with a plug according to UNE 20315:1994.</p> <p>Supply cords of single-phase equipment having a rated current not exceeding 2,5 A shall be provided with a plug according to UNE-EN 50075:1993.</p> <p>CLASS I EQUIPMENT provided with socket-outlets with earth contacts or which are intended to be used in locations where protection against indirect contact is required according to the wiring rules, shall be provided with a plug in accordance with standard UNE 20315:1994.</p> <p>If poly-phase equipment is provided with a supply cord with a plug, this plug shall be in accordance with UNE-EN 60309-2.</p> | | | | | | | | | | | | | | | | | | | | | | | | |

| Clause | Special national condition |
|---------|--|
| 3.2.1.1 | <p>In the United Kingdom, apparatus which is fitted with a flexible cable or cord and is designed to be connected to a mains socket conforming to BS 1363 by means of that flexible cable or cord and plug, shall be fitted with a 'standard plug' in accordance with Statutory Instrument 1768:1994 - The Plugs and Sockets etc. (Safety) Regulations 1994, unless exempted by those regulations.</p> <p>NOTE 'Standard plug' is defined in SI 1768:1994 and essentially means an approved plug conforming to BS 1363 or an approved conversion plug.</p> |
| 3.2.1.1 | <p>In Ireland, apparatus which is fitted with a flexible cable or cord and is designed to be connected to a mains socket conforming to I.S. 411 by means of that flexible cable or cord and plug, shall be fitted with a 13 A plug in accordance with Statutory Instrument 525:1997 - National Standards Authority of Ireland (section 28) (13 A Plugs and Conversion Adaptors for Domestic Use) Regulations 1997.</p> |
| 3.2.4 | <p>In Switzerland, for requirements see 3.2.1.1 of this annex.</p> |
| 3.2.5.1 | <p>In the United Kingdom, a power supply cord with conductor of 1,25 mm² is allowed for equipment with a rated current over 10 A and up to and including 13 A.</p> |
| 3.3.4 | <p>In the United Kingdom, the range of conductor sizes of flexible cords to be accepted by terminals for equipment with a RATED CURRENT of over 10 A up to and including 13 A is:</p> <p style="padding-left: 40px;">1,25 mm² to 1,5 mm² nominal cross-sectional area.</p> |
| 4.3.6 | <p>In the United Kingdom, the torque test is performed using a socket outlet complying with BS 1363 part 1:1995, including Amendment 1: 1997 and Amendment 2:2003 and the plug part of DIRECT PLUG-IN EQUIPMENT shall be assessed to BS 1363: Part 1, 12.1, 12.2, 12.3, 12.9, 12.11, 12.12, 12.13, 12.16 and 12.17, except that the test of 12.17 is performed at not less than 125 °C. Where the metal earth pin is replaced by an Insulated Shutter Opening Device (ISOD), the requirements of clauses 22.2 and 23 also apply.</p> |
| 4.3.6 | <p>In Ireland, DIRECT PLUG-IN EQUIPMENT is known as plug similar devices. Such devices shall comply with Statutory Instrument 526:1997 - National Standards Authority of Ireland (Section 28) (Electrical plugs, plug similar devices and sockets for domestic use) Regulations, 1997.</p> |
| 5.1.7.1 | <p>In Finland, Norway and Sweden TOUCH CURRENT measurement results exceeding 3,5 mA r.m.s. are permitted only for the following equipment:</p> <p style="padding-left: 40px;">STATIONARY PLUGGABLE EQUIPMENT TYPE A that</p> <ul style="list-style-type: none"> ○ is intended to be used in a RESTRICTED ACCESS LOCATION where equipotential bonding has been applied, for example, in a telecommunication centre; and ○ has provision for a permanently connected PROTECTIVE EARTHING CONDUCTOR; and ○ is provided with instructions for the installation of that conductor by a SERVICE PERSON; <p style="padding-left: 40px;">STATIONARY PLUGGABLE EQUIPMENT TYPE B;</p> <p style="padding-left: 40px;">STATIONARY PERMANENTLY CONNECTED EQUIPMENT.</p> |

| Clause | Special national condition |
|---------|---|
| 6.1.2.1 | <p>In Finland, Norway and Sweden, add the following text between the first and second paragraph of the compliance clause:</p> <p>If this insulation is solid, including insulation forming part of a component, it shall at least consist of either</p> <ul style="list-style-type: none"> - two layers of thin sheet material, each of which shall pass the electric strength test below, or - one layer having a distance through insulation of at least 0,4 mm, which shall pass the electric strength test below. <p>If this insulation forms part of a semiconductor component (e.g. an optocoupler), there is no distance through insulation requirement for the insulation consisting of an insulating compound completely filling the casing, so that CLEARANCES and CREEPAGE DISTANCES do not exist, if the component passes the electric strength test in accordance with the compliance clause below and in addition</p> <ul style="list-style-type: none"> - passes the tests and inspection criteria of 2.10.11 with an electric strength test of 1,5 kV multiplied by 1,6 (the electric strength test of 2.10.10 shall be performed using 1,5 kV), and - is subject to ROUTINE TESTING for electric strength during manufacturing, using a test voltage of 1,5 kV. <p>It is permitted to bridge this insulation with a capacitor complying with EN 132400:1994, subclass Y2.</p> <p>A capacitor classified Y3 according to EN 132400:1994, may bridge this insulation under the following conditions:</p> <ul style="list-style-type: none"> - the insulation requirements are satisfied by having a capacitor classified Y3 as defined by EN 132400, which in addition to the Y3 testing, is tested with an impulse test of 2,5 kV defined in EN 60950-1:2006, 6.2.2.1; - the additional testing shall be performed on all the test specimens as described in EN 132400; - the impulse test of 2,5 kV is to be performed before the endurance test in EN 132400, in the sequence of tests as described in EN 132400. |
| 6.1.2.2 | <p>In Finland, Norway and Sweden, the exclusions are applicable for PERMANENTLY CONNECTED EQUIPMENT, PLUGGABLE EQUIPMENT TYPE B and equipment intended to be used in a RESTRICTED ACCESS LOCATION where equipotential bonding has been applied, e.g. in a telecommunication centre, and which has provision for a permanently connected PROTECTIVE EARTHING CONDUCTOR and is provided with instructions for the installation of that conductor by a SERVICE PERSON.</p> |
| 7.2 | <p>In Finland, Norway and Sweden, for requirements see 6.1.2.1 and 6.1.2.2 of this annex. The term TELECOMMUNICATION NETWORK in 6.1.2 being replaced by the term CABLE DISTRIBUTION SYSTEM.</p> |
| 7.3 | <p>In Norway and Sweden, there are many buildings where the screen of the coaxial cable is normally not connected to the earth in the building installation.</p> |
| 7.3 | <p>In Norway, for installation conditions see EN 60728-11:2005.</p> |

Annex ZC
(informative)



A-deviations

A-deviation: National deviation due to regulations, the alteration of which is for the time being outside the competence of the CENELEC national member.

This European Standard falls under Directive 73/23/EEC and 1999/5/EC.

NOTE (from CEN/CENELEC IR Part 2:2002 , 2.17) Where standards fall under EC Directives, it is the view of the Commission of the European Communities (OJ No C 59, 1982-03-09) that the effect of the decision of the Court of Justice in case 815/79 Cremonini/Vrankovich (European Court Reports 1980, p. 3583) is that compliance with A-deviations is no longer mandatory and that the free movement of products complying with such a standard should not be restricted except under the safeguard procedure provided for in the relevant Directive.

A-deviations in an EFTA-country are valid instead of the relevant provisions of the European Standard in that country until they have been removed.

| Clause | National deviation |
|---------|---|
| 1.5.1 | <p>Sweden (Ordinance 1990:944)</p> <p>Add the following:</p> <p>NOTE In Sweden, switches containing mercury are not permitted.</p> |
| 1.5.1 | <p>Switzerland (Ordinance on environmentally hazardous substances SR 814.081, Annex 1.7, Mercury - Annex 1.7 of SR 814.81 applies for mercury.)</p> <p>Add the following:</p> <p>NOTE In Switzerland, switches containing mercury such as thermostats, relays and level controllers are not allowed.</p> |
| 1.7.2.1 | <p>Denmark (Heavy Current Regulations)</p> <p>Supply cords of CLASS I EQUIPMENT, which is delivered without a plug, must be provided with a visible tag with the following text:</p> <p style="text-align: center;">Vigtigt!</p> <p style="text-align: center;">Lederen med grøn/gul isolation</p> <p style="text-align: center;">må kun tilsluttes en klemme mærket</p> <p style="text-align: center;">  eller  </p> <p>If essential for the safety of the equipment, the tag must in addition be provided with a diagram, which shows the connection of the other conductors, or be provided with the following text:</p> <p>“For tilslutning af de øvrige ledere, se medfølgende installationsvejledning.”</p> |

| Clause | National deviation |
|---------|---|
| 1.7.2.1 | <p>Germany (Gesetz über technische Arbeitsmittel und Verbraucherprodukte (Geräte- und Produktsicherheitsgesetz – GPSG) [Law on technical labour equipment and consumer products], of 6th January 2004, Section 2, Article 4, Clause (4), Item 2).</p> <p>If for the assurance of safety and health certain rules during use, amending or maintenance of a technical labour equipment or readymade consumer product are to be followed, a manual in German language has to be delivered when placing the product on the market.</p> <p>Of this requirement, rules for use even only by SERVICE PERSONS are not exempted.</p> |
| 1.7.5 | <p>Denmark (Heavy Current Regulations)</p> <p>With the exception of CLASS II EQUIPMENT provided with a socket outlet in accordance with the Heavy Current Regulations, Section 107-2-D1, Standard Sheet DK 1-4a, CLASS II EQUIPMENT shall not be fitted with socket-outlets for providing power to other equipment.</p> |
| 1.7.13 | <p>Switzerland (Ordinance on chemical hazardous risk reduction SR 814.81, Annex 2.15 Batteries)</p> <p>Annex 2.15 of SR 814.81 applies for batteries.</p> |
| 5.1.7.1 | <p>Denmark (Heavy Current Regulations, Chapter 707, clause 707.4)</p> <p>TOUCH CURRENT measurement results exceeding 3,5 mA r.m.s. are permitted only for PERMANENTLY CONNECTED EQUIPMENT and PLUGGABLE EQUIPMENT TYPE B.</p> |

WORLD



沃德检测

blank

BSI — British Standards Institution

BSI is the independent national body responsible for preparing British Standards. It presents the UK view on standards in Europe and at the international level. It is incorporated by Royal Charter.

Revisions

British Standards are updated by amendment or revision. Users of British Standards should make sure that they possess the latest amendments or editions.

It is the constant aim of BSI to improve the quality of our products and services. We would be grateful if anyone finding an inaccuracy or ambiguity while using this British Standard would inform the Secretary of the technical committee responsible, the identity of which can be found on the inside front cover. Tel: +44 (0)20 8996 9000. Fax: +44 (0)20 8996 7400.

BSI offers members an individual updating service called PLUS which ensures that subscribers automatically receive the latest editions of standards.

Buying standards

Orders for all BSI, international and foreign standards publications should be addressed to Customer Services. Tel: +44 (0)20 8996 9001. Fax: +44 (0)20 8996 7001. Email: orders@bsi-global.com. Standards are also available from the BSI website at <http://www.bsi-global.com>.

In response to orders for international standards, it is BSI policy to supply the BSI implementation of those that have been published as British Standards, unless otherwise requested.

Information on standards

BSI provides a wide range of information on national, European and international standards through its Library and its Technical Help to Exporters Service. Various BSI electronic information services are also available which give details on all its products and services. Contact the Information Centre. Tel: +44 (0)20 8996 7111. Fax: +44 (0)20 8996 7048. Email: info@bsi-global.com.

Subscribing members of BSI are kept up to date with standards developments and receive substantial discounts on the purchase price of standards. For details of these and other benefits contact Membership Administration. Tel: +44 (0)20 8996 7002. Fax: +44 (0)20 8996 7001. Email: membership@bsi-global.com.

Information regarding online access to British Standards via British Standards Online can be found at <http://www.bsi-global.com/bsonline>.

Further information about BSI is available on the BSI website at <http://www.bsi-global.com>.

Copyright

Copyright subsists in all BSI publications. BSI also holds the copyright, in the UK, of the publications of the international standardization bodies. Except as permitted under the Copyright, Designs and Patents Act 1988 no extract may be reproduced, stored in a retrieval system or transmitted in any form or by any means – electronic, photocopying, recording or otherwise – without prior written permission from BSI.

This does not preclude the free use, in the course of implementing the standard, of necessary details such as symbols, and size, type or grade designations. If these details are to be used for any other purpose than implementation then the prior written permission of BSI must be obtained.

Details and advice can be obtained from the Copyright & Licensing Manager. Tel: +44 (0)20 8996 7070. Fax: +44 (0)20 8996 7553. Email: copyright@bsi-global.com.

English version

**Information technology equipment -
Safety -
Part 1: General requirements**

Matériel de traitement de l'information -
Sécurité -
Partie 1: Exigences générales

Einrichtungen der Informationstechnik -
Sicherheit -
Teil 1: Allgemeine Anforderungen

This amendment A11 modifies the European Standard EN 60950-1:2006; it was approved by CENELEC on 2008-12-01. CENELEC members are bound to comply with the CEN/CENELEC Internal Regulations which stipulate the conditions for giving this amendment the status of a national standard without any alteration.

Up-to-date lists and bibliographical references concerning such national standards may be obtained on application to the Central Secretariat or to any CENELEC member.

This amendment exists in three official versions (English, French, German). A version in any other language made by translation under the responsibility of a CENELEC member into its own language and notified to the Central Secretariat has the same status as the official versions.

CENELEC members are the national electrotechnical committees of Austria, Belgium, Bulgaria, Cyprus, the Czech Republic, Denmark, Estonia, Finland, France, Germany, Greece, Hungary, Iceland, Ireland, Italy, Latvia, Lithuania, Luxembourg, Malta, the Netherlands, Norway, Poland, Portugal, Romania, Slovakia, Slovenia, Spain, Sweden, Switzerland and the United Kingdom.

CENELEC

European Committee for Electrotechnical Standardization
Comité Européen de Normalisation Electrotechnique
Europäisches Komitee für Elektrotechnische Normung

Central Secretariat: avenue Marnix 17, B - 1000 Brussels

Foreword

This amendment to the European Standard EN 60950-1:2006 was prepared by the Technical Committee CENELEC TC 108X, Safety of electronic equipment within the fields of audio/video, information technology and communication technology.

The text of the draft was submitted to the Unique Acceptance Procedure and was approved by CENELEC as amendment A11 to EN 60950-1:2006 on 2008-12-01.

The following dates were fixed:

- latest date by which the amendment has to be implemented at national level by publication of an identical national standard or by endorsement (dop) 2009-12-01
- latest date by which the national standards conflicting with the amendment have to be withdrawn (dow) 2010-12-01

Replace the current Annex ZA by the following:

Annex ZA
(normative)

**Normative references to international publications
with their corresponding European publications**

The following referenced documents are indispensable for the application of this document. For dated references, only the edition cited applies. For undated references, the latest edition of the referenced document (including any amendments) applies.

NOTE Where an International Publication has been modified by common modifications, indicated by (mod), the relevant EN/HD applies.

| <u>Publication</u> | <u>Year</u> | <u>Title</u> | <u>EN/HD</u> | <u>Year</u> |
|-----------------------|-----------------|---|-------------------------|----------------------|
| IEC 60065 (mod) A1 | 2001 2005 | Audio, video and similar electronic apparatus - Safety requirements | EN 60065 A1 + A11 | 2002 2006 2008 |
| A2 | - ¹⁾ | | A2 | - ¹⁾ |
| IEC 60068-2-78 | - ²⁾ | Environmental testing Part 2-78: Tests - Test Cab: Damp heat, steady state | EN 60068-2-78 | 2001 ³⁾ |
| IEC 60073 | - ²⁾ | Basic and safety principles for man-machine interface, marking and identification - Coding principles for indication devices and actuators | EN 60073 | 2002 ³⁾ |
| IEC 60083 | - ²⁾ | Plugs and socket-outlets for domestic and similar general use standardized in member countries of IEC | - | - |
| IEC 60085 | 2004 | Electrical insulation - Thermal classification | EN 60085 | 2004 |
| IEC 60112 | - ²⁾ | Method for determining the proof and comparative tracking indices of insulating materials | EN 60112 | 2003 ³⁾ |
| IEC 60216-4-1 | - ²⁾ | Guide for the determination of thermal endurance properties of electrical insulating materials Part 4: Ageing ovens Section 1: Single-chamber ovens | EN 60216-4-1 | 2006 ³⁾ |
| IEC 60227 (mod) | Series | Polyvinyl chloride insulated cables of rated voltages up to and including 450/750V | HD 21 ⁴⁾ | Series |
| IEC 60245 (mod) | Series | Rubber insulated cables of rated voltages up to and including 450/750V | HD 22 ⁵⁾ | Series |

1) At draft stage.

2) Undated reference.

3) Valid edition at date of issue.

4) The HD 21 series is related to, but not directly equivalent with the IEC 60227 series.

5) The HD 22 series is related to, but not directly equivalent with the IEC 60245 series.

| <u>Publication</u> | <u>Year</u> | <u>Title</u> | <u>EN/HD</u> | <u>Year</u> |
|-----------------------------|----------------------|---|-------------------------|--|
| IEC 60309 (mod) | Series | Plugs, socket-outlets and couplers for industrial purposes | EN 60309 | Series |
| IEC 60317 | Series | Specifications for particular types of winding wires | EN 60317 | Series |
| IEC 60317-43 | - ²⁾ | Part 43: Aromatic polyimide tape wrapped round copper wire, class 240 | EN 60317-43 | 1997 ³⁾ |
| IEC 60320 (mod) | Series | Appliance couplers for household and similar general purposes | EN 60320 | Series |
| IEC 60364-1 (mod) | 2001 | Electrical installations of buildings Part 1: Fundamental principles, assessment of general characteristics, definitions | HD 384.1 S2 | 2001 |
| IEC 60384-14 A1 | 1993 1995 | Fixed capacitors for use in electronic equipment Part 14: Sectional specification: Fixed capacitors for electromagnetic interference suppression and connection to the supply mains | EN 132400 ⁶⁾ | 1994 |
| IEC 60417 | Data- base | Graphical symbols for use on equipment | - | - |
| IEC 60664-1 + A1 + A2 | 1992 2000 2002 | Insulation coordination for equipment within low-voltage systems Part 1: Principles, requirements and tests | EN 60664-1 | 2003 |
| IEC 60695-2-11 | - ²⁾ | Fire hazard testing Part 2-11: Glowing/hot-wire based test methods - Glow-wire flammability test method for end-products | EN 60695-2-11 | 2001 ³⁾ |
| IEC 60695-2-20 | - ²⁾ | Part 2-20: Glowing/hot-wire based test methods - Hot-wire coil ignitability - Apparatus, test method and guidance | - | - |
| IEC 60695-10-2 | - ²⁾ | Part 10-2: Guidance and test methods for the minimization of the effects of abnormal heat on electrotechnical products involved in fires - Method for testing products made from non-metallic materials for resistance to heat using the ball pressure test | EN 60695-10-2 | 2003 ³⁾ |
| IEC 60695-11-3 | - ²⁾ | Part 11-3: Test flames - 500 W flames - Apparatus and confirmational test methods | - | - |
| IEC 60695-11-4 | - ²⁾ | Part 11-4: Test flames - 50 W flames - Apparatus and confirmational test methods | - | - |
| IEC 60695-11-10 A1 | - ²⁾ | Part 11-10: Test flames - 50 W horizontal and vertical flame test methods | EN 60695-11-10 A1 | 1999 ³⁾ 2003 ³⁾ |

⁶⁾ EN 132400, *Sectional Specification: Fixed capacitors for electromagnetic interference suppression and connection to the supply mains (Assessment level D)*, and its amendments are related to, but not directly equivalent to IEC 60384-14. They are superseded by EN 60384-14:2005, which is based on IEC 60384-14:2005.

| <u>Publication</u> | <u>Year</u> | <u>Title</u> | <u>EN/HD</u> | <u>Year</u> |
|-------------------------|----------------------|--|--|--|
| IEC 60695-11-20 A1 | - ²⁾ | Part 11-20: Test flames - 500 W flame test methods | EN 60695-11-20 A1 | 1999 ³⁾ 2003 ³⁾ |
| IEC 60730-1 (mod) A1 | 1999 2003 | Automatic electrical controls for household and similar use Part 1: General requirements | EN 60730-1 A1 + A12 + A13 + A14 + A16 | 2000 2004 2003 2004 2005 2007 |
| A2 | 2007 | | A2 | 2008 |
| IEC 60747-5-5 | 2007 | Semiconductor devices - Discrete devices Part 5-5: Optoelectronic devices - Photocouplers | EN 60747-5-5 | - ¹⁾ |
| IEC 60825-1 | - ²⁾ | Safety of laser products Part 1: Equipment classification, requirements and user's guide | EN 60825-1 | 2007 ³⁾ |
| IEC 60825-2 | - ²⁾ | Part 2: Safety of optical fibre communication systems | EN 60825-2 A1 | 2004 ³⁾ 2007 ³⁾ |
| IEC/TR 60825-9 | - ²⁾ | Part 9: Compilation of maximum permissible exposure to incoherent optical radiation | - | - |
| IEC 60825-12 | - ²⁾ | Part 12: Safety of free space optical communication systems used for transmission of information | EN 60825-12 | 2004 ³⁾ |
| IEC 60851-3 A1 | 1996 1997 | Winding wires - Test methods Part 3: Mechanical properties | EN 60851-3 A1 | 1996 1997 |
| IEC 60851-5 A1 A2 | 1996 1997 2004 | Part 5: Electrical properties | EN 60851-5 A1 A2 | 1996 1997 2004 |
| IEC 60851-6 | 1996 | Part 6: Thermal properties | EN 60851-6 | 1996 |
| IEC 60885-1 | 1987 | Electrical test methods for electric cables Part 1: Electrical tests for cables, cords and wires for voltages up to and including 450/750 V | - | - |
| IEC 60906-1 | - ²⁾ | IEC System of plugs and socket-outlet for household and similar purposes Part 1: Plugs and socket-outlets 16 A 250 V a.c. | - | - |
| IEC 60906-2 | - ²⁾ | Part 2: Plugs and socket-outlets 15 A 125 V a.c. | - | - |
| IEC 60947-1 | 2004 | Low voltage switchgear and control gear Part 1: General rules | EN 60947-1 | 2004 |
| IEC 60990 | 1999 | Methods of measurement of touch current and protective conductor current | EN 60990 | 1999 |

| <u>Publication</u> | <u>Year</u> | <u>Title</u> | <u>EN/HD</u> | <u>Year</u> |
|---------------------------------|-----------------|---|--------------------------|--------------------|
| IEC 61051-2 | 1991 | Varistors for use in electronic equipment Part 2: Sectional specification for surge suppression varistors | - | - |
| IEC 61058-1 (mod) | 2000 | Switches for appliances Part 1: General requirements | EN 61058-1 ⁷⁾ | 2002 |
| ISO 178 | - ²⁾ | Plastics - Determination of flexural properties | EN ISO 178 | 2003 ³⁾ |
| ISO 179 | Series | Plastics - Determination of Charpy impact strength | EN ISO 179 | Series |
| ISO 180 | - ²⁾ | Plastics - Determination of Izod impact strength | EN ISO 180 | 2000 ³⁾ |
| ISO 261 | - ²⁾ | ISO general-purpose metric screw threads - General plan | - | - |
| ISO 262 | - ²⁾ | ISO general-purpose metric screw threads - Selected sizes for screws, bolts and nuts | - | - |
| ISO 527 | Series | Plastics - Determination of tensile properties | EN ISO 527 | Series |
| ISO 3864 | Series | Safety colours and safety signs | - | - |
| ISO 4892-1 | - ²⁾ | Plastics - Methods of exposure to laboratory light sources Part 1: General guidance | EN ISO 4892-1 | 2000 ³⁾ |
| ISO 4892-2 | - ²⁾ | Part 2: Xenon-arc sources | EN ISO 4892-2 | 2006 ³⁾ |
| ISO 4892-4 | - ²⁾ | Part 4: Open-flame carbon-arc lamps | - | - |
| ISO 7000 | Data- base | Graphical symbols for use on equipment - Index and synopsis | - | - |
| ISO 8256 | - ²⁾ | Plastics - Determination of tensile-impact strength | EN ISO 8256 | 2004 ³⁾ |
| ISO 9772 | - ²⁾ | Cellular plastics - Determination of horizontal burning characteristics of small specimens subjected to a small flame | - | - |
| ISO 9773 | - ²⁾ | Plastics - Determination of burning behaviour of thin flexible vertical specimens in contact with a small-flame ignition source | EN ISO 9773 | 1998 ³⁾ |
| ITU-T Recommendation K.44 | - ²⁾ | Resistibility tests for telecommunication equipment exposed to overvoltages and overcurrents - Basic Recommendation | - | - |

⁷⁾ EN 61058-1:2002 includes A1:2001 to IEC 61058-1:2000.

Annex ZB
(normative)

Special national conditions

Special national condition: National characteristic or practice that cannot be changed even over a long period, e.g. climatic conditions, electrical earthing conditions.

NOTE If it affects harmonization, it forms part of the European Standard.

For the countries in which the relevant special national conditions apply these provisions are normative, for other countries they are informative.

Change the existing special national conditions as follows:

| Clause | Special national condition |
|-----------|--|
| 1.2.13.14 | <p>Add as new SNC:</p> <p>In Norway and Sweden, for requirements see 1.7.2.1 and 7.3 of this annex.</p> |
| 1.5.7.1 | <p>Replace the existing SNC by the following:</p> <p>In Finland, Norway and Sweden, resistors bridging BASIC INSULATION in CLASS I PLUGGABLE EQUIPMENT TYPE A must comply with the requirements in 1.5.7.1. In addition when a single resistor is used, the resistor must withstand the resistor test in 1.5.7.2.</p> <p>Add as new SNC:</p> |
| 1.7.2.1 | <p>In Norway and Sweden, the screen of the cable distribution system is normally not earthed at the entrance of the building and there is normally no equipotential bonding system within the building. Therefore the protective earthing of the building installation need to be isolated from the screen of a cable distribution system.</p> <p>It is however accepted to provide the insulation external to the equipment by an adapter or an interconnection cable with galvanic isolator, which may be provided by e.g. a retailer.</p> <p>The user manual shall then have the following or similar information in Norwegian and Swedish language respectively, depending on in what country the equipment is intended to be used in:</p> <p>“Equipment connected to the protective earthing of the building installation through the mains connection or through other equipment with a connection to protective earthing – and to a cable distribution system using coaxial cable, may in some circumstances create a fire hazard. Connection to a cable distribution system has therefore to be provided through a device providing electrical isolation below a certain frequency range (galvanic isolator, see EN 60728-11).”</p> <p>NOTE In Norway, due to regulation for installations of cable distribution systems, and in Sweden, a galvanic isolator shall provide electrical insulation below 5 MHz. The insulation shall withstand a dielectric strength of 1.5 kV r.m.s., 50 Hz or 60 Hz, for 1 min.</p> |

| Clause | Special national condition |
|--------|---|
| | <p>Translation to Norwegian (the Swedish text will also be accepted in Norway):</p> <p>”Utstyr som er koplet til beskyttelsesjord via nettplugg og/eller via annet jordtilkoplede utstyr – og er tilkoplede et kabel-TV nett, kan forårsake brannfare. For å unngå dette skal det ved tilkopling av utstyret til kabel-TV nettet installeres en galvanisk isolator mellom utstyret og kabel- TV nettet.”</p> <p>Translation to Swedish:</p> <p>”Utrustning som är kopplad till skyddsjord via jordat vägguttag och/eller via annan utrustning och samtidigt är kopplad till kabel-TV nät kan i vissa fall medföra risk för brand. För att undvika detta skall vid anslutning av utrustningen till kabel-TV nät galvanisk isolator finnas mellan utrustningen och kabel-TV nätet.”</p> |
| 1.7.5 | <p>Add the following paragraph to the existing SNC for Denmark:</p> <p>For CLASS II EQUIPMENT the socket outlet shall be in accordance with Standard Sheet DKA 1-4a.</p> |
| 7.3 | <p>Delete the existing SNC for Norway and Sweden (based on NOTE 1 of IEC 60950-1:2005 + corr. 1).</p> <p>Add as new SNC (based on future NOTE 3 of IEC 60950-1:200X):</p> <p>In Norway and Sweden, for requirements see 1.2.13.14 and 1.7.2.1 of this annex.</p> |

Annex ZC (informative)

A-deviations

A-deviation: National deviation due to regulations, the alteration of which is for the time being outside the competence of the CENELEC national member.

This European Standard falls under Directives RTTED (1999/5/EC) and LVD (2006/95/EC).

NOTE (from CEN/CENELEC IR Part 2:2006, 2.17) Where standards fall under EC Directives, it is the view of the Commission of the European Communities (OJ No. C 59, 1982-03-09) that the effect of the decision of the Court of Justice in case 815/79 Cremonini/Vrankovich (European Court Reports 1980, p. 3583) is that compliance with A-deviations is no longer mandatory and that the free movement of products complying with such a standard should not be restricted within the EC except under the safeguard procedure provided for in the relevant Directive.

A-deviations in an EFTA-country are valid instead of the relevant provisions of the European Standard in that country until they have been removed.

| Clause | Deviation |
|---------|---|
| 1.5.1 | Sweden Delete the A-deviation. |
| 1.7.2.1 | Denmark Delete the A-deviation. |
| 1.7.5 | Denmark Delete the A-deviation. |
| 5.1.7.1 | Denmark Delete the A-deviation. |

WORLD



沃德检测

English version

**Information technology equipment -
Safety -
Part 1: General requirements**
(IEC 60950-1:2005/A1:2009, modified)

Matériel de traitement de l'information -
Sécurité -
Partie 1: Exigences générales
(CEI 60950-1:2005/A1:2009, modifié)

Einrichtungen der Informationstechnik -
Sicherheit -
Teil 1: Allgemeine Anforderungen
(IEC 60950-1:2005/A1:2009, modifiziert)

This amendment A1 modifies the European Standard EN 60950-1:2006; it was approved by CENELEC on 2010-03-01. CENELEC members are bound to comply with the CEN/CENELEC Internal Regulations which stipulate the conditions for giving this amendment the status of a national standard without any alteration.

Up-to-date lists and bibliographical references concerning such national standards may be obtained on application to the Central Secretariat or to any CENELEC member.

This amendment exists in three official versions (English, French, German). A version in any other language made by translation under the responsibility of a CENELEC member into its own language and notified to the Central Secretariat has the same status as the official versions.

CENELEC members are the national electrotechnical committees of Austria, Belgium, Bulgaria, Croatia, Cyprus, the Czech Republic, Denmark, Estonia, Finland, France, Germany, Greece, Hungary, Iceland, Ireland, Italy, Latvia, Lithuania, Luxembourg, Malta, the Netherlands, Norway, Poland, Portugal, Romania, Slovakia, Slovenia, Spain, Sweden, Switzerland and the United Kingdom.

CENELEC

European Committee for Electrotechnical Standardization
Comité Européen de Normalisation Electrotechnique
Europäisches Komitee für Elektrotechnische Normung

Central Secretariat: Avenue Marnix 17, B - 1000 Brussels

Foreword

The text of document 108/350/FDIS, future amendment 1 to IEC 60950-1:2005, prepared by IEC TC 108, Safety of electronic equipment within the field of audio/video, information technology and communication technology, was submitted to the IEC-CENELEC parallel vote.

A draft amendment, prepared by the Technical Committee CENELEC TC 108X, Safety of electronic equipment within the fields of audio/video, information technology and communication technology, was submitted simultaneously to the formal vote.

The combined texts were approved by CENELEC as amendment A1 to EN 60950-1:2006 on 2010-03-01.

Attention is drawn to the possibility that some of the elements of this document may be the subject of patent rights. CEN and CENELEC shall not be held responsible for identifying any or all such patent rights.

The following dates were fixed:

- latest date by which the amendment has to be implemented at national level by publication of an identical national standard or by endorsement (dop) 2011-03-01
- latest date by which the national standards conflicting with the amendment have to be withdrawn (dow) 2013-03-01

Subclauses, tables and figures which are additional to those in IEC 60950-1 are prefixed “Z”.

Annexes ZA and ZB have been added by CENELEC.

Endorsement notice

The text of amendment A1:2009 to the International Standard IEC 60950-1:2005 was approved by CENELEC as an amendment to the European Standard with agreed common modifications as given below.

COMMON MODIFICATIONS

In IEC 60950-1:2005/A1 delete all the “country” notes according to the following list:

- 1.5.7.1: Note
- 6.1.2.1: Note 2
- 6.2.2.1: Note 2
- EE.3: Note

For special national conditions, see Annex ZB.

1.1.1 Replace the text of NOTE 3 by the following

NOTE 3 The requirements of EN 60065 may also be used to meet safety requirements for multimedia equipment. See IEC Guide 112, *Guide on the safety of multimedia equipment*. For television sets EN 60065 applies.

1.2.3 Add the following definition:

1.2.3.Z1

PORTABLE SOUND SYSTEM

small battery powered audio equipment:

- whose prime purpose is to listen to recorded or broadcasted sound; and
- that uses headphones or earphones that can be worn in or on or around the ears; and
- that allows the user to walk around

NOTE Examples are mini-disk or CD players; MP3 audio players or similar equipment.

1.7.2.1 Delete NOTE Z1.

Add the following paragraph at the end of the subclause:

In addition, for a **PORTABLE SOUND SYSTEM**, the instructions shall include a warning that excessive sound pressure from earphones and headphones can cause hearing loss.

4.3.13.6 Replace the existing NOTE by the following:

NOTE Z1 Attention is drawn to :

1999/519/EC: Council Recommendation on the limitation of exposure of the general public to electromagnetic fields 0 Hz to 300 GHz, and

2006/25/EC: Directive on the minimum health and safety requirements regarding the exposure of workers to risks arising from physical agents (artificial optical radiation).

Standards taking into account mentioned Recommendation and Directive which demonstrate compliance with the applicable EU Directive are indicated in the OJEC.

Bibliography Add the following note for the standard indicated:

IEC 60908 NOTE Harmonized as EN 60908.

Replace the entire Annex ZA by the following:

Annex ZA (normative)

Normative references to international publications with their corresponding European publications

The following referenced documents are indispensable for the application of this document. For dated references, only the edition cited applies. For undated references, the latest edition of the referenced document (including any amendments) applies.

NOTE When an international publication has been modified by common modifications, indicated by (mod), the relevant EN/HD applies.

| <u>Publication</u> | <u>Year</u> | <u>Title</u> | <u>EN/HD</u> | <u>Year</u> |
|-----------------------|--------------|--|-------------------------|----------------------|
| | | Insulating, sheathing and covering materials for low-voltage energy cables | EN 50363 | Series |
| | | Electrical test methods for low voltage energy cables | EN 50395 | 2005 |
| | | Non electrical test methods for low voltage energy cables | EN 50396 | 2005 |
| IEC 60065 (mod) A1 | 2001 2005 | Audio, video and similar electronic apparatus – Safety requirements | EN 60065 A1 + A11 | 2002 2006 2008 |
| A2 | - | | A2 + A12 | - |
| IEC 60068-2-78 | - | Environmental testing Part 2-78: Tests – Test Cab: Damp heat, steady state | EN 60068-2-78 | - |
| IEC 60073 | - | Basic and safety principles for man-machine interface, marking and identification – Coding principles for indication devices and actuators | EN 60073 | - |
| IEC 60083 | - | Plugs and socket-outlets for domestic and similar general use standardized in member countries of IEC | - | - |
| IEC 60085 | 2004 | Electrical insulation – Thermal classification | EN 60085 | 2004 |
| IEC 60112 | - | Method for determining the proof and comparative tracking indices of insulating materials | EN 60112 | - |
| IEC 60227 (mod) | Series | Polyvinyl chloride insulated cables of rated voltages up to and including 450/750V | HD 21 ¹⁾ | Series |
| IEC 60245 (mod) | Series | Rubber insulated cables of rated voltages up to and including 450/750V | HD 22 ²⁾ | Series |

¹⁾ The HD 21 series is related to, but not directly equivalent with the IEC 60227 series. Also EN 50363, EN 50395 and EN 50386 are to be taken into account.

²⁾ The HD 22 series is related to, but not directly equivalent with the IEC 60245 series. Also EN 50363, EN 50395 and EN 50386 are to be taken into account.

| <u>Publication</u> | <u>Year</u> | <u>Title</u> | <u>EN/HD</u> | <u>Year</u> |
|-----------------------|----------------------|---|-------------------|-------------|
| IEC 60309 | Series | Plugs, socket-outlets and couplers for industrial purposes | EN 60309 | Series |
| IEC 60317 | Series | Specifications for particular types of winding wires | EN 60317 | Series |
| IEC 60317-43 | - | Part 43: Aromatic polyimide tape wrapped round copper wire, class 240 | EN 60317-43 | - |
| IEC 60320 (mod) | Series | Appliance couplers for household and similar general purposes | EN 60320 | Series |
| IEC 60364-1 (mod) | 2001 | Electrical installations of buildings Part 1: Fundamental principles, assessment of general characteristics, definitions | HD 384.1 S2 | 2001 |
| IEC 60384-14 A1 | 1993 1995 | Fixed capacitors for use in electronic equipment Part 14: Sectional specification: Fixed capacitors for electromagnetic interference suppression and connection to the supply mains | EN 60384-14 | 2005 |
| IEC 60417 | Data-base | Graphical symbols for use on equipment | - | - |
| IEC 60664-1 + A1 + A2 | 1992 2000 2002 | Insulation coordination for equipment within low-voltage systems Part 1: Principles, requirements and tests | EN 60664-1 | 2003 |
| IEC 60695-2-11 | - | Fire hazard testing Part 2-11: Glowing/hot-wire based test methods – Glow-wire flammability test method for end-products | EN 60695-2-11 | - |
| IEC 60695-2-20 | - | Part 2-20: Glowing/hot-wire based test methods – Hot-wire coil ignitability – Apparatus, test method and guidance | - | - |
| IEC 60695-10-2 | - | Part 10-2: Guidance and test methods for the minimization of the effects of abnormal heat on electrotechnical products involved in fires – Method for testing products made from non-metallic materials for resistance to heat using the ball pressure test | EN 60695-10-2 | - |
| IEC 60695-10-3 | - | Fire hazard testing Part 10-3: Abnormal heat – Mould stress relief distortion test | EN 60695-10-03 | - |
| IEC 60695-11-3 | - | Part 11-3: Test flames – 500 W flames – Apparatus and conformational test methods | - | - |
| IEC 60695-11-4 | - | Part 11-4: Test flames – 50 W flames – Apparatus and conformational test methods | - | - |
| IEC 60695-11-10 A1 | - | Part 11-10: Test flames – 50 W horizontal and vertical flame test methods | EN 60695-11-10 A1 | - |

| <u>Publication</u> | <u>Year</u> | <u>Title</u> | <u>EN/HD</u> | <u>Year</u> |
|----------------------------|----------------------|--|---|--|
| IEC 60695-11-20 A1 | - | Part 11-20: Test flames – 500 W flame test methods | EN 60695-11-20 A1 | - - |
| IEC 60730-1 (mod) A1 | 1999 2003 | Automatic electrical controls for household and similar use - Part 1: General requirements | EN 60730-1 A1 + A12 + A13 + A14 + A15 + A16 A2 | 2000 2004 2003 2004 2005 2007 2007 2008 |
| A2 | 2007 | | | |
| IEC 60747-5-5 | 2007 | Semiconductor devices – Discrete devices Part 5-5: Optoelectronic devices – Photocouplers | EN 60747-5-5 | - |
| IEC 60825-1 | - | Safety of laser products Part 1: Equipment classification, requirements and user's guide | EN 60825-1 | - |
| IEC 60825-2 | - | Part 2: Safety of optical fibre communication systems | EN 60825-2 A1 | - - |
| IEC/TR 60825-9 | - | Part 9: Compilation of maximum permissible exposure to incoherent optical radiation | - | - |
| IEC 60825-12 | - | Part 12: Safety of free space optical communication systems used for transmission of information | EN 60825-12 | - |
| IEC 60851-3 A1 | 1996 1997 | Winding wires – Test methods Part 3: Mechanical properties | EN 60851-3 A1 | 1996 1997 |
| IEC 60851-5 A1 A2 | 1996 1997 2004 | Part 5: Electrical properties | EN 60851-5 A1 A2 | 1996 1997 2004 |
| IEC 60851-6 | 1996 | Part 6: Thermal properties | EN 60851-6 | 1996 |
| IEC 60885-1 | 1987 | Electrical test methods for electric cables Part 1: Electrical tests for cables, cords and wires for voltages up to and including 450/750 V | - | - |
| IEC 60906-1 | - | IEC System of plugs and socket-outlet for household and similar purposes Part 1: Plugs and socket-outlets 16 A 250 V a.c. | - | - |
| IEC 60906-2 | - | Part 2: Plugs and socket-outlets 15 A 125 V a.c. | - | - |
| IEC 60947-1 | 2004 | Low voltage switchgear and control gear Part 1: General rules | EN 60947-1 | 2004 |
| IEC 60990 | 1999 | Methods of measurement of touch current and protective conductor current | EN 60990 | 1999 |

| <u>Publication</u> | <u>Year</u> | <u>Title</u> | <u>EN/HD</u> | <u>Year</u> |
|---------------------------------|---------------|---|--------------------------|-------------|
| IEC 61051-2 | 1991 | Varistors for use in electronic equipment Part 2: Sectional specification for surge suppression varistors | - | - |
| IEC 61058-1 (mod) | 2000 | Switches for appliances Part 1: General requirements | EN 61058-1 ³⁾ | 2002 |
| IEC 62471 (mod) | - | Photobiological safety of lamps and lamp systems | EN 62471 | - |
| ISO 178 | - | Plastics - Determination of flexural properties | EN ISO 178 | 2003 |
| ISO 179 | Series | Plastics - Determination of Charpy impact strength | EN ISO 179 | Series |
| ISO 180 | - | Plastics - Determination of Izod impact strength | EN ISO 180 | - |
| ISO 261 | - | ISO general-purpose metric screw threads - General plan | - | - |
| ISO 262 | - | ISO general-purpose metric screw threads - Selected sizes for screws, bolts and nuts | - | - |
| ISO 527 | Series | Plastics - Determination of tensile properties | EN ISO 527 | Series |
| ISO 3864 | Series | Safety colours and safety signs | - | - |
| ISO 4892-1 | - | Plastics - Methods of exposure to laboratory light sources Part 1: General guidance | EN ISO 4892-1 | - |
| ISO 4892-2 | - | Part 2: Xenon-arc sources | EN ISO 4892-2 | - |
| ISO 4892-4 | - | Part 4: Open-flame carbon-arc lamps | - | - |
| ISO 7000 | Data- base | Graphical symbols for use on equipment - Index and synopsis | - | - |
| ISO 8256 | - | Plastics - Determination of tensile-impact strength | EN ISO 8256 | - |
| ISO 9772 | - | Cellular plastics - Determination of horizontal burning characteristics of small specimens subjected to a small flame | - | - |
| ISO 9773 | - | Plastics - Determination of burning behaviour of thin flexible vertical specimens in contact with a small-flame ignition source | EN ISO 9773 | - |
| ITU-T Recommendation K.44 | - | Resistibility tests for telecommunication equipment exposed to overvoltages and overcurrents - Basic Recommendation | - | - |

³⁾ EN 61058-1:2002 includes A1:2001 to IEC 61058-1:2000.

Annex ZB (normative)

Special National Conditions

Special national condition: National characteristic or practice that cannot be changed even over a long period, e.g. climatic conditions, electrical earthing conditions. If it affects harmonization, it forms part of the European Standard or Harmonization Document.

For the countries in which the relevant special national apply these provisions are normative, for other countries they are informative.

Add the following special national condition:

| Clause | Special national condition |
|---------|--|
| 1.5.7.1 | <p>In Finland, Norway and Sweden</p> <p>No changes needed - Correction of SNC already Part of A11.</p> |
| 6.1.2.1 | <p>In Finland, Norway and Sweden, add the following text between the first and second paragraph of the compliance clause:</p> <p>If this insulation is solid, including insulation forming part of a component, it shall at least consist of either</p> <ul style="list-style-type: none"> - two layers of thin sheet material, each of which shall pass the electric strength test below, or - one layer having a distance through insulation of at least 0,4 mm, which shall pass the electric strength test below. <p>Alternatively for components, there is no distance through insulation requirement for the insulation consisting of an insulating compound completely filling the casing, so that CLEARANCES and CREEPAGE DISTANCES do not exist, if the component passes the electric strength test in accordance with the compliance clause below and in addition</p> <ul style="list-style-type: none"> - passes the tests and inspection criteria of 2.10.11 with an electric strength test of 1,5 kV multiplied by 1,6 (the electric strength test of 2.10.10 shall be performed using 1,5 kV), and - is subject to ROUTINE TESTING for electric strength during manufacturing, using a test voltage of 1,5 kV. <p>It is permitted to bridge this insulation with an optocoupler complying with 2.10.5.4 b).</p> <p>It is permitted to bridge this insulation with a capacitor complying with EN 60384-14:2005, subclass Y2.</p> <p>A capacitor classified Y3 according to EN 60384-14:2005, may bridge this insulation under the following conditions:</p> <ul style="list-style-type: none"> - the insulation requirements are satisfied by having a capacitor classified Y3 as defined by EN 60384-14, which in addition to the Y3 testing, is tested with an impulse test of 2,5 kV defined in EN 60950-1:2006, 6.2.2.1; - the additional testing shall be performed on all the test specimens as described in EN 60384-14; - the impulse test of 2,5 kV is to be performed before the endurance test in EN 60384-14, in the sequence of tests as described in EN 60384-14. |



EN

ÖVE/ÖNORM
60950-1

Edition: 2011-09-01

Information technology equipment – Safety Part 1: General requirements

(IEC 60950-1:2005 + Cor.:2006 + A1:2009, modified)

Einrichtungen der Informationstechnik – Sicherheit –

Teil 1: Allgemeine Anforderungen

(IEC 60950-1:2005 + Cor.:2006 + A1:2009, modifiziert)

Matériel de traitement de l'information – Sécurité – Partie 1: Exigences générales

(CEI 60950-1:2005 + Cor.:2006 + A1:2009, modifiée)

Publisher and printing:

OVE Austrian Electrotechnical Association
Austrian Standards Institute

ICS

35.020; 35.260

Copyright © OVE/Austrian Standards Institute – 2011. All rights reserved.

No part of this publication may be reproduced or utilized in any form or by any means – electronic, mechanical, photocopying or any other data carries without prior permission!

Not equal (NEQ)
Identical (IDT) with

IEC 60950-1:2005 + Cor.:2006 + A1:2009
EN 60950-1:2006 + A11:2009 + A1:2010 + A12:2011

Supersedes

see National Foreword

Responsibility

OVE/Komitee
TK IT-EG
Informationstechnologie, Telekommunikation und
Elektronik

Sales and distribution:

Austrian Standards Institute
Heinestraße 38, 1020 Vienna
E-Mail: sales@as-plus.at
Internet: <http://www.as-plus.at>
Tel.: +43 1 213 00-444
Fax: +43 1 213 00-818

OVE Austrian Electrotechnical Association
Eschenbachgasse 9, 1010 Vienna
E-Mail: verkauf@ove.at
Internet <http://www.ove.at>
Webshop: <https://www.ove.at/webshop>
Tel.: +43 1 587 63 73
Fax: +43 1 586 74 08

AS:+ Shop 19 09 2011

ÖVE/ÖNORM EN 60950-1:2011

National Foreword

This European Standard EN 60950-1:2006 + A11:2009 + A1:2010 + A12:2011 has the status of an Austrian Electrotechnical Regulation in accordance with the Austrian Electrotechnical Act 1992 and the status of an Austrian Standard in accordance with the Austrian Federal Act on Standardization 1971.

The legal status of this Austrian Electrotechnical Regulation/Austrian Standard is stated in the respective decree under the Electrotechnical Act.

European Standards (EN) are implemented as Austrian Electrotechnical Regulations/Austrian Standards according to the common CEN/GENELEC Internal Regulations by publication of an identical text and by adding ÖVE/ÖNORM to the EN number.

According to the foreword of the EN the latest date by which the national standards conflicting with the EN have to be withdrawn is 2013-01-24 (dow, date of withdrawal). Until this deadline the following standard may be applied:

ÖVE/ÖNORM EN 60950-1:2011-03-01.

沃德检测

English version

**Information technology equipment -
Safety -
Part 1: General requirements**

Matériel de traitement de l'information -
Sécurité -
Partie 1: Exigences générales

Einrichtungen der Informationstechnik -
Sicherheit -
Teil 1: Allgemeine Anforderungen

This amendment A12 modifies the European Standard EN 60950-1:2006; it was approved by CENELEC on 2011-01-24. CENELEC members are bound to comply with the CEN/CENELEC Internal Regulations which stipulate the conditions for giving this amendment the status of a national standard without any alteration.

Up-to-date lists and bibliographical references concerning such national standards may be obtained on application to the Central Secretariat or to any CENELEC member.

This amendment exists in three official versions (English, French, German). A version in any other language made by translation under the responsibility of a CENELEC member into its own language and notified to the Central Secretariat has the same status as the official versions.

CENELEC members are the national electrotechnical committees of Austria, Belgium, Bulgaria, Croatia, Cyprus, the Czech Republic, Denmark, Estonia, Finland, France, Germany, Greece, Hungary, Iceland, Ireland, Italy, Latvia, Lithuania, Luxembourg, Malta, the Netherlands, Norway, Poland, Portugal, Romania, Slovakia, Slovenia, Spain, Sweden, Switzerland and the United Kingdom.

CENELEC

European Committee for Electrotechnical Standardization
Comité Européen de Normalisation Electrotechnique
Europäisches Komitee für Elektrotechnische Normung

Management Centre: Avenue Marnix 17, B - 1000 Brussels

Foreword

This amendment to the European Standard EN 60950-1:2006 was prepared by the Technical Committee CENELEC TC 108X, Safety of electronic equipment within the fields of audio/video, information technology and communication technology.

The text of the draft was submitted to the unique acceptance procedure and was approved by CENELEC as amendment A12 to EN 60950-1:2006 on 2011-01-24.

Attention is drawn to the possibility that some of the elements of this document may be the subject of patent rights. CEN and CENELEC shall not be held responsible for identifying any or all such patent rights.

The following dates were fixed:

- latest date by which the amendment has to be implemented at national level by publication of an identical national standard or by endorsement (dop) 2012-01-24
- latest date by which the national standards conflicting with the amendment have to be withdrawn (dow) 2013-01-24

Sub-clauses, tables and figures which are additional to those in IEC 60950-1:2005 are prefixed “Z”.